



2015
CATALOG



5 CATEGORIES

No one company brings together more innovative products and solutions for the full spectrum of restaurant and facilities operations than San Jamar.

INNOVATION:

Our approach? We identify real problems faced by real users in real situations. Then we solve them.

UNSURPASSED QUALITY:

We make products that last, to build relationships that last.

CHANNEL PARTNERS:

Innovative training, compelling marketing, merchandising and effective product promotion.

MARKET KNOWLEDGE:

We get it. We've been there, in the kitchen, in the facilities, behind the bar and in the trenches. Real world experience that has paid off with real, effective solutions.



sanjamar.com

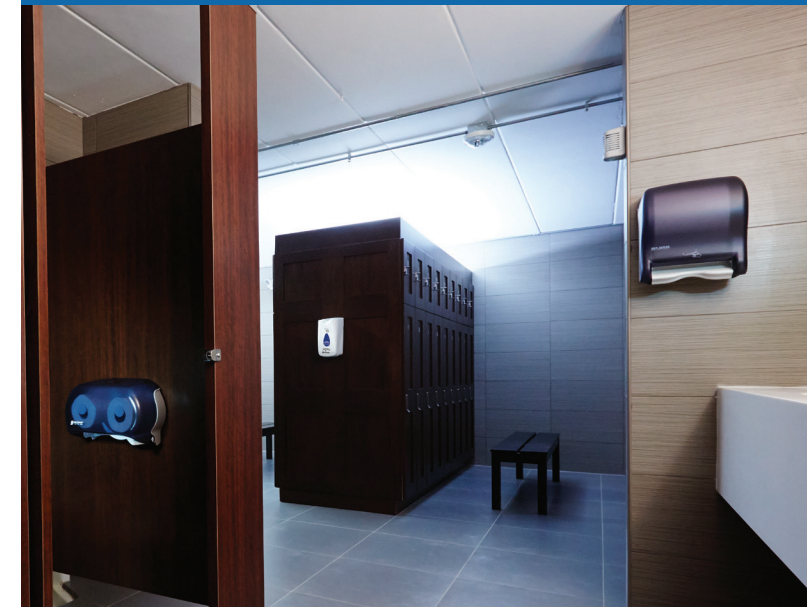

Counter Service



Food Safety Tools



Bar & Food Management



Personal Safety





PAGE

6

Washroom & Hygiene Solutions

8

Towel Dispensers

- No-Touch Roll Towel
- Touch Roll Towel
- Folded Towel

16

Tissue Dispensers

- Standard Bath Tissue
- Jumbo Bath Tissue

22

Soap & Other Dispensers

- Soap Dispensers
- Other Dispensers

26

Chemicals

- Wet Wipes
- Chemicals
- Odor Control

PAGE

32

Counter Service

34

Napkin Dispensers

- In-Counter Napkin
- Tabletop Napkin
- Counter/Wall Mount Napkin

40

Cup & Lid Dispensers

- Cup & Lid Systems
- In-Counter Cup
- Surface Mount Cup
- Lid & Straw

PAGE

54

Food Safety Tools

56

Safe Ice Handling

- Totes
- Scoops & Holders

60

Safe Food Preparation

- Cold Paddles
- Cold Serve
- Safe Prep

66

Sanitation Tools

- Pails
- Tools

70

Cutting Boards

- Grip Boards
- Standard Boards
- Specialty & Custom Boards
- Accessories

PAGE

78

Bar and Food Management

80

Bar Management

- Garnish Centers
- Bar Tools
- Shelf Matting

88

Food Management

- Food Storage
- Chef Tools
- Condiment Centers
- Pump Centers
- Dessert

100

Kitchen Management

- Check Management
- Flatware Management
- Food Carriers
- Floor Matting

PAGE

106

Personal Safety

108

Temperature Protection Mitts

- High Performance
- Value Added
- Economy

114

Temperature Protection Gloves & Sleeves

- Hot Oil Gloves
- Temperature Gloves
- Temperature Sleeves

118

Temperature Protection Holders

- Pot Holders
- Pan Grabbers
- Handle Holders

124

Cut Protection

- Cut Protection Gloves
- Safety Aids

128

Chemical Protection

- Gloves
- Utility Aprons
- Splash Resistant Aprons

RECENT INNOVATIONS

San Jamar offers a steady stream of innovation with **over 50 new products** all designed to make your operation **smarter, safer, and more sanitary.**

Smart Essence™ Towel Dispenser Page 9		Toilet Seat Cover Dispensers Page 25		Arriba™ Snap Aerosol Fragrances Page 31	
10" Simplicity Hands Free Mechanical Page 11		Assure™ Wet Wipes Dispenser Page 27		Venue® In-Counter Napkin Dispensers Page 35	
Oceans Simplicity Hands-Free Mechanical Page 11		Assure™ Wet Wipes Page 28		Venue® Tabletop Napkin Dispensers Page 37	
Compact Simplicity Hands-Free Mechanical Page 11		BluNaturale™ Page 28		Wireworks™ Cup Dispenser & Lid Organizer Page 44	
Adjustable Centerpull Towel Page 12		Saf-T-Ice™ Descaler Page 28		Saf-T-Ice® Cart Page 58	
Adjustable Mini Centerpull Towel Page 12		Saf-T-Drain™ Page 28		Banquet/Beverage Saf-T-Scoop® Page 58	
Countertop Towel Page 15		Arriba™ Twist Solaire™ Page 29		Saf-T-Scoop® & Guardian™ System Page 59	
4-Station Carousel Page 18		Arriba™ Starter Packs Page 29		Saf-T-Wrap® 12" & 18" Page 64	
Rely™ Hybrid Soap & Sanitizer Dispensers Page 23		Arriba™ Snap LCD Dispensers Page 30		Saf-T-Wrap® Stackers Page 64	
Rely™ Manual Soap & Sanitizer Dispensers Page 23		Arriba™ Snap LED Dispensers Page 30		Saf-T-Knife® Station Page 65	

Saf-T-Knife® Station Jr. Page 65		The Dome® Glass Rimming Station Page 82		Cool Touch™ Oven Mitt Page 110	
Allergen Saf-T-Zone™ Thermometer Page 65		Dome® Stacker Page 83, 92		UltiGrips® Oven Mitt Page 110	
Kleen-Pail® Stands Page 68		Non-Alcoholic Bar Mat Page 85		Cool Touch Flame™ Hot Pads Page 119	
Kleen-Pail® Detergent & Sanitizer Page 68		ModPans™ Page 89		UltiGrips® Hot Pads Page 120	
Saf-T-Grip® Cutting Boards 9" x 12" Page 71		Professional Squeeze Bottles Page 90		Hand Safety Organizer Page 123	
Saf-T-Grip® White Cutting Boards Page 72		Pizza Bags Page 103		Klever Kutter™ Carton Opener Page 127	
Saf-T-Grip® White 4-Board System Page 72		Cool Touch Flame™ Oven Mitt Page 109		BreadGuard™ Page 127	
				ProGrip™ Page 131	

Make your dispensers more affordable. Talk to your representative about

Download the San Jamar Restaurant Solutions App today!

AVAILABLE ON THE APPLE™ APP STORE & GOOGLE PLAY™

P.A.S.S.



WASHROOM & HYGIENE SOLUTIONS

Throughout our history, San Jamar has been a pioneer in Disposables Dispensing. Whether it's Universal Touchless Towel dispensing, one-at-a-time cup, lid and napkin dispensing, one-of-a-kind electronic soap dispensing or state-of-the-art air care systems; our innovative solutions will improve hygiene, provide for the best cost in use, will organize your environment and enhance its image.



TOWEL DISPENSERS

TISSUE DISPENSERS

**SOAP & OTHER
DISPENSERS**

CHEMICALS





TOWEL DISPENSERS

NO-TOUCH ROLL TOWEL

TOUCH ROLL TOWEL

FOLDED TOWEL

NO-TOUCH ROLL TOWEL

- Touchless towel dispensers offer the best option for sanitary hand hygiene
- San Jamar leads the industry in Universal Touchless Electronic dispensing with four options: Smart Essence™, Tear-N-Dry Essence™, Smart System with I.Q. Sensor™, and the Tear-N-Dry. Each of these durable dispensers offer:
 - Best battery life in industry
 - Fast, reliable performance
 - Dispensing all types of 8" roll towel paper up to 800' – any brand or quality



T8400TBK

Smart Essence™

- Adjustable paper length (8", 12", 16") and delay (0, 1½, 3 seconds)
- Compact, high capacity
- Durable and economical

Item	Color	Capacity	Core Diameter	Dimensions H x W x D
CLASSIC STYLE				
T8400*	TBL, TBK, WH	(1) 8" (200 mm) wide roll	1½" (38 mm)	147/16" x 11¾" x 9½" (367 x 298 x 232 mm)
OCEANS® STYLE				
T8490*	TBL, TBK	(1) 8" (200 mm) wide roll	1½" (38 mm)	147/16" x 11¾" x 9½" (367 x 298 x 232 mm)

Requires 4 D-cell alkaline batteries



“ The Smart Essence gives me the high capacity I need for tight spaces; as well as reliable touchless dispensing with the flexibility to adjust length and time depending on environment. ~ Carrie L. ”

* Specify desired color after item number. Example: T8400TBL





T8000TBK

T8090TBL

Tear-N-Dry Essence™

- Consistently dispenses standard 10" length paper without a wait
- Compact, high capacity
- Durable and economical

Item	Color	Capacity	Core Diameter	Dimensions H x W x D
CLASSIC STYLE				
T8000*	TBL, TBK, WH	(1) 8" (200 mm) wide roll	1½" (38 mm)	14 ⁷ / ₁₆ " x 11 ³ / ₄ " x 9 ¹ / ₈ " (367 x 298 x 232 mm)
OCEANS® STYLE				
T8090*	TBL, TBK	(1) 8" (200 mm) wide roll	1½" (38 mm)	14 ⁷ / ₁₆ " x 11 ³ / ₄ " x 9 ¹ / ₈ " (367 x 298 x 232 mm)

Requires 4 D-cell alkaline batteries



T1300TBK

T1390TBL

Tear-N-Dry

- Consistently dispenses standard 10" length paper without a wait
- Infinity System® automatic transfer system eliminates stub roll waste
- Replaceable drive module

Item	Color	Capacity	Core Diameter	Dimensions H x W x D
CLASSIC STYLE				
T1300*	TBL, TBK	8" (200 mm) wide roll dia. and 3.5" (100 mm) dia. stub roll	1½" (38 mm)	16 ¹ / ₂ " x 11 ³ / ₄ " x 9 ¹ / ₄ " (419 x 298 x 235 mm)
OCEANS® STYLE				
T1390*	TBL, TBK	8" (200 mm) wide roll dia. and 3.5" (100 mm) dia. stub roll	1½" (38 mm)	16 ¹ / ₂ " x 11 ³ / ₄ " x 9 ¹ / ₄ " (419 x 298 x 235 mm)

Requires 4 D-cell alkaline batteries



T1400TBL

T1490TBK

Smart System WITH I.Q. SENSOR™

- Adjustable paper length (8", 12", 16") and delay (0, 1½, 3 seconds)
- Infinity System® automatic transfer system eliminates stub roll waste
- Replaceable drive module

Item	Color	Capacity	Core Diameter	Dimensions H x W x D
CLASSIC STYLE				
T1400*	TBL, TBK, WH	8" (200 mm) wide roll dia. and 4" (100 mm) dia. stub roll	1½" (38 mm)	16 ¹ / ₂ " x 11 ³ / ₄ " x 9 ¹ / ₄ " (419 x 298 x 235 mm)
T1400TBKHW**	TBK	8" (200 mm) wide roll dia. and 4" (100 mm) dia. stub roll	1½" (38 mm)	16 ¹ / ₂ " x 11 ³ / ₄ " x 9 ¹ / ₄ " (419 x 298 x 235 mm)
OCEANS® STYLE				
T1490*	TBL, TBK	8" (200 mm) wide roll dia. and 4" (100 mm) dia. stub roll	1½" (38 mm)	16 ¹ / ₂ " x 11 ³ / ₄ " x 9 ¹ / ₄ " (419 x 298 x 235 mm)

Requires 4 D-cell alkaline batteries

**Includes hand washing sticker



Simplicity Hands-Free Mechanical

- Does not require batteries
- Hands-free dispensing for most types of roll towel
- Automatic mechanical cutting dispenses 11" portions of roll towel
- Replaceable drive module

Item	Color	Capacity	Core Diameter	Dimensions H x W x D
CLASSIC STYLE				
T7000*	TBL, TBK	8" (200 mm) wide; 8" (200 mm) dia. roll Up to 4" (100 mm) dia. stub roll	1½" (38mm)	16 ¹ / ₂ " x 11 ³ / ₄ " x 9 ¹ / ₄ " (419 x 298 x 235 mm)
OCEANS® STYLE				
T7090*	TBL, TBK	8" (200 mm) wide; 8" (200 mm) dia. roll Up to 4" (100 mm) dia. stub roll	1½" (38mm)	16 ¹ / ₂ " x 11 ³ / ₄ " x 9 ¹ / ₄ " (419 x 298 x 235 mm)



T7090TBL

T7000TBK

10" Simplicity Hands-Free Mechanical

- Does not require batteries
- Hands-free dispensing for most types of 10" roll towel
- Automatic mechanical cutting dispenses 12" portions of roll towel

Item	Color	Capacity	Core Diameter	Dimensions H x W x D
CLASSIC STYLE				
T7100*	TBL, TBK	10" (254 mm) wide; 8" (200 mm) dia. roll Up to 4" (100 mm) dia. stub roll	1½" (38mm)	16 ⁵ / ₈ " x 14 ⁷ / ₈ " x 9 ³ / ₈ " (422 x 378 x 238 mm)

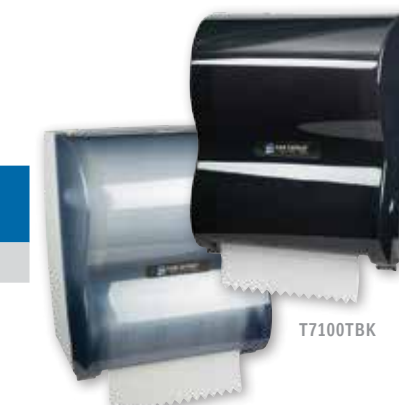

T7100TBL

T7100TBK

Compact Simplicity Hands-Free Mechanical

- Does not require batteries
- Hands free dispensing for most types of 6" roll towel
- Automatic mechanical cutting dispenses 11" portions of roll towel

Item	Color	Capacity	Core Diameter	Dimensions H x W x D
CLASSIC STYLE				
T7500*	TBL, TBK	8" (200 mm) wide; 6" (152 mm) dia. roll	1½" (38 mm)	12 ¹ / ₄ " x 12 ³ / ₈ " x 7 ⁵ / ₈ " (311 x 314 x 194 mm)
OCEANS® STYLE				
T7590*	TBL, TBK	8" (200 mm) wide; 6" (152 mm) dia. roll	1½" (38 mm)	12 ¹ / ₄ " x 12 ³ / ₈ " x 7 ⁵ / ₈ " (311 x 314 x 194 mm)



T7590TBL

T7500TBK

* Specify desired color after item number. Example: T8000TBL

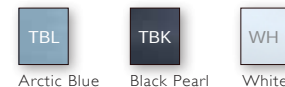



T410TBK

Adjustable Centerpull Towel

- Easy to adjust funnel
- High capacity (9½" diameter roll)
- Universal centerpull dispenser, adjusts for all grades of paper from single ply to industrial wipes

Item	Color	Capacity	Dimensions H x W x D
T410*	TBL, TBK	9½" (241 mm) wide; 9½" (241 mm) dia. roll	13¾" x 9¾" x 9¾" (340 x 244 x 238 mm)

Construction: Impact resistant plastic



T450TBL

Adjustable Mini Centerpull Towel

- Easy to adjust funnel
- Compact (6" diameter roll)
- Universal centerpull dispenser, adjusts for all grades of paper from single ply to industrial wipes

Item	Color	Capacity	Dimensions H x W x D
T450*	TBL, TBK	6" (152 mm) dia. roll	12¾" x 7½" x 7¾" (314 x 190 x 187 mm)

Construction: Impact resistant plastic



T400TBK

Centerpull Towel

- Large capacity ensures long intervals between refills
- Dispenses single sheets of one-ply perforated towels

Item	Color	Capacity	Dimensions H x W x D
T400*	TBL, TBK	9½" (241 mm) wide; 9" (230 mm) dia. roll	11¾" x 9¾" x 9¾" (295 x 232 x 241 mm)

Construction: Impact resistant plastic



Perforated Roll Towel

Item	Color	Capacity	Dimensions H x W x D
T451XC	XC	11" (280 mm) wide roll	2¾" x 13¾" x 4¾" (73 x 337 x 117 mm)

Construction: 24-gauge steel



TOUCH ROLL TOWEL

- San Jamar's Universal Touch Roll Towel dispensers are the lowest cost way to dispense the lowest cost paper, hardwound roll towel
- Simple, intuitive designs
- Engineered for ease of use and minimal maintenance
- Impact resistant plastic for durability

Element™ Lever Roll Towel

- Compact, high capacity - 33% smaller than average roll towel dispenser
- Ergonomic handle; simple, efficient & easy to use
- Accepts any core size, including coreless, solid & centerpull rolls



T950TBL

Item	Color	Capacity	Core Diameter	Dimensions H x W x D
CLASSIC STYLE				
T950*	TBL, TBK	8" (200 mm) wide; 8" (200 mm) dia. roll	All paper qualities with any size core	12¾" x 12½" x 8½" (324 x 318 x 216 mm)
OCEANS® STYLE				
T990*	TBL, TBK	8" (200 mm) wide; 8" (200 mm) dia. roll	All paper qualities with any size core	12¾" x 12½" x 8½" (324 x 318 x 216 mm)

Construction: Impact resistant plastic

Lever Roll Towel WITH AUTO TRANSFER

- Infinity System® automatic transfer system eliminates stub roll waste
- Replaceable drive module
- Simple, efficient & easy to use



T1190TBL

T1100TBK

Item	Color	Capacity	Core Diameter	Dimensions H x W x D
CLASSIC STYLE				
T1100*	TBL, TBK, WH	8" (200 mm) wide; 8" (200 mm) dia. roll Up to 4" dia. (100 mm) stub roll	1½" (38 mm)	16½" x 12 ¹⁵ / ₁₆ " x 9¼" (419 x 329 x 235 mm)
OCEANS® STYLE				
T1190*	TBL, TBK	8" (200 mm) wide; 8" (200 mm) dia. roll Up to 4" dia. (100 mm) stub roll	1½" (38 mm)	16½" x 12 ¹⁵ / ₁₆ " x 9¼" (419 x 329 x 235 mm)

Construction: Impact resistant plastic

Integra™ Lever Roll Towel

- Integrated dispensing arm for hands-free alternative dispensing
- Compact, high capacity
- Accepts any core size, including coreless, solid and centerpull rolls



T850TBL

Item	Color	Capacity	Core Diameter	Dimensions H x W x D
T850*	TBL, TBK	8½" (215 mm) dia. 8¾" (209 mm) wide	All paper qualities with any size core	13½" x 11½" x 11¼" (342 x 292 x 285 mm)

Construction: Impact resistant plastic

Crank Roll Towel

Item	Color	Capacity	Dimensions H x W x D
T800WH	WH	9" (230 mm) wide roll; 7¾" (197 mm) dia. roll	10½" x 11" x 8½" (267 x 279 x 216 mm)

Construction: 20-gauge steel



* Specify desired color after item number. Example: T410TBL

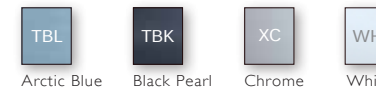

FOLDED TOWEL

Another great solution to touchless dispensing are San Jamar's folded towel dispensers. Our patented Ultrafold™ line saves dramatically on towel waste with smooth, one-at-a-time dispensing every time. Ultrafold™ dispensers are:

- Available in a variety of sizes for either compact or high capacity applications
- Designed to dispense any brand or quality of C-Fold or Multifold towels one-at-a-time, reducing waste
- Designed to eliminate overstuffing
- Constructed of impact resistant plastic



T1755TBK

Ultrafold™ Fusion™ Multifold/C-Fold Towel

- 50% smaller carton to save on warehouse and transportation costs
- Simple, 6 piece assembly

Item	Color	Capacity	Dimensions H x W x D
T1755*	TBL, TBK	400 Multifold /240 C-Fold	11½" x 11½" x 6" (292 x 292 x 152 mm)

Construction: Impact resistant plastic



T1750TBL



Ultrafold™ Multifold/C-Fold Towel

- Compact
- Saves money with less towel waste

Item	Color	Capacity	Dimensions H x W x D
CLASSIC STYLE			
T1750*	TBL, TBK, WH	400 Multifold / 240 C-Fold	11½" x 11½" x 6" (292 x 292 x 152 mm)
OCEANS® STYLE			
T1759*	TBL, TBK	400 Multifold / 240 C-Fold	11½" x 11½" x 6" (292 x 292 x 152 mm)

Construction: Impact resistant plastic



T1759TBK

T1700TBK



Large Capacity Ultrafold™ Multifold/C-Fold Towel

- High capacity, reduces need to refill frequently

Item	Color	Capacity	Dimensions H x W x D
CLASSIC STYLE			
T1700*	TBL, TBK,	750 Multifold / 450 C-Fold	18" x 11¼" x 6¼" (475 x 298 x 159 mm)
OCEANS® STYLE			
T1790*	TBL, TBK	750 Multifold / 450 C-Fold	18" x 11¼" x 6¼" (475 x 298 x 159 mm)

Construction: Impact resistant plastic



T1790TBL

Countertop Towel

- Compact, ideal for spaces where wall mount dispensers are not an option
- Protects against moisture and contaminates

Item	Color	Capacity	Dimensions H x W x D
T1720*	TBL, TBK	(1) Stack Multifold/C-fold/Singlefold	7" x 11" x 4¾" (178 x 279 x 111 mm)

Construction: Impact resistant plastic



T1720TBK

True Fold™ C-Fold/Multifold Towel

- Operator-friendly flip door eliminates towel waste

Item	Color	Capacity	Dimensions H x W x D
T1905*	XC, WH	500 Multifold / 300 C-fold	14½" x 11¾" x 5" (368 x 295 x 127 mm)

Construction: metal front/impact resistant plastic back



T1905XC

C-Fold/Multifold Towel

Item	Color	Capacity	Dimensions H x W x D
T1900*	XC, SS	500 Multifold / 300 C-fold	14¾" x 11¾" x 4" (375 x 289 x 102 mm)

Construction: 20-gauge steel



T1900XC

Mini C-Fold/Multifold Towel

Item	Color	Capacity	Dimensions H x W x D
T1950XC	XC	250 Multifold / 150 C-fold	7½" x 11¼" x 3¾" (200 x 283 x 98 mm)

Construction: 20-gauge steel



T1950XC

Singlefold Towel

Item	Color	Capacity	Dimensions H x W x D
T1800*	XC, WH	500 Singlefold	7½" x 10¾" x 6" (191 x 273 x 152 mm)

Construction: 20-gauge steel



T1800XC

* Specify desired color after item number. Example: T1755TBL



TISSUE DISPENSERS

STANDARD TISSUE

JUMBO BATH TISSUE

STANDARD BATH TISSUE

- Standard bath tissue dispensers offer a professional looking solution for dispensing both standard or industrial bath tissue



R3600TBL



R3690TBK

Versatwin® Tissue

- Accepts standard/industrial bath tissue
- Continual availability of paper provided by the Infinity System® eliminating stub roll waste

Item	Color	Capacity	Core Diameter	Dimensions H x W x D
CLASSIC STYLE				
R3600*	TBL, TBK	(2) 4½-5½" (115-140 mm) rolls	Min. 1½" (38 mm)	12¾" x 8" x 5¾" (324 x 311 x 146 mm)
OCEANS® STYLE				
R3690*	TBL, TBK	(2) 4½-5½" (115-140 mm) rolls	Min. 1½" (38 mm)	12¾" x 8" x 5¾" (324 x 311 x 146 mm)

Construction: Impact resistant plastic

“ The Versatwin is easy to service - helps eliminate waste by using the full roll. ~ Pat D. ”

* Specify desired color after item number. Example: R3600TBL





Duett Standard Bath Tissue

- Accepts standard/industrial bath tissue
- Continual availability of paper provided by the Infinity System®, eliminating stub roll waste
- Compact design

Item	Color	Capacity	Core Diameter	Dimensions H x W x D
CLASSIC STYLE				
R3500*	TBL, TBK	(2) 4½-5½" (115-140 mm) rolls	1⅝" (40 mm)	12¾" x 7½" x 7" (324 x 191 x 178 mm)
OCEANS® STYLE				
R3590*	TBL, TBK	(2) 4½-5½" (115-140 mm) rolls	1⅝" (40 mm)	12¾" x 7½" x 7" (324 x 191 x 178 mm)

Construction: Impact resistant plastic

Locking Toilet Tissue

- Accommodates 4" (102 mm) wide roll

Item	Color	Capacity	Core Diameter	Dimensions H x W x D
R200XC	XC	(1) standard rolls	Min. 1½" (38 mm)	2¾" x 6" x 4½" (70 x 152 x 114 mm)
R260XC	XC	(2) standard rolls	Min. 1½" (38 mm)	2¾" x 12¾" x 4½" (70 x 314 x 114 mm)

Construction: 20-gauge steel



4-Station Carousel

- Multiple roll system to reduce run-outs and waste
- High capacity, holds four 5" rolls of standard bath tissue
- Uses rolls sequentially to eliminate stub roll waste

Item	Color	Capacity	Core Diameter	Dimensions H x W x D
R3800*	TBL, TBK	(4) standard rolls	Min. 1½" (38 mm)	14⅞" x 13⅞" x 6⅞" (378 x 333 x 156 mm)

Construction: Impact resistant plastic

Non-Locking Toilet Tissue

Item	Color	Capacity	Core Diameter	Dimensions H x W x D
R1200XC	XC	(1) standard rolls	Min. 1½" (38 mm)	2½" x 6¼" x 4⅞" (64 x 159 x 124 mm)

Construction: 20-gauge steel



Covered Reserve Roll Tissue

Item	Color	Capacity	Core Diameter	Dimensions H x W x D
R1500*	XC, WH	(2) standard rolls	Min. 1½" (38 mm)	6" x 10" x 6¼" (152 x 254 x 159 mm)

Construction: 20-gauge steel

* Specify desired color after item number. Example: R3500TBL



JUMBO BATH TISSUE



Twin 9" JBT

- Industry leading dispenser
- Continual availability of paper provided by the Infinity System[®], eliminating stub roll waste

Item	Color	Capacity	Core Diameter	Dimensions H x W x D
CLASSIC STYLE				
R4000*	TBL, TBK	(2) 9" (230 mm) JBT rolls	Min. 3¼" (83 mm)	12" x 19" x 5¼" (305 x 483 x 133 mm)
OCEANS [®] STYLE				
R4090*	TBL, TBK	(2) 9" (230 mm) JBT rolls	Min. 3¼" (83 mm)	12" x 19" x 5¼" (305 x 483 x 133 mm)

Construction: Impact resistant plastic



Reserva[®] 9"-10½" JBT

- Holds one 9-10½" (230-270 mm) jumbo bath roll and one 5" (127 mm) single stub roll
- Continual availability of paper provided by the Infinity System[®], eliminating stub roll waste

Item	Color	Capacity	Core Diameter	Dimensions H x W x D
CLASSIC STYLE				
R3000*	TBL, TBK	(1) 9-10½" (230-270 mm) JBT roll (1) 5" (127 mm) stub roll	Min. 3¼" (83 mm)	13½" x 16½" x 5½" (343 x 419 x 143 mm)
OCEANS [®] STYLE				
R3090*	TBL, TBK	(1) 9-10½" (230-270 mm) JBT roll (1) 5" (127 mm) stub roll	Min. 3¼" (83 mm)	12¼" x 16¾" x 5½" (311 x 425 x 140 mm)

Construction: Impact resistant plastic

Single 9" JBT

- Designed to provide ease-of-use, with easy paper access and multi-directional tearing

Item	Color	Capacity	Core Diameter	Dimensions H x W x D
CLASSIC STYLE				
R2000*	TBL, TBK	(1) 9" (230 mm) JBT roll	3¼" (83 mm)	12" x 10¼" x 5½" (305 x 260 x 143 mm)
OCEANS [®] STYLE				
R2090*	TBL, TBK	(1) 9" (230 mm) JBT roll	3¼" (83 mm)	12" x 10¼" x 5½" (305 x 260 x 143 mm)

Construction: Impact resistant plastic



Single 12" JBT

- Designed to provide ease-of-use, with easy paper access and multi-directional tearing
- EZ Turn[™] mandrel dispenses large rolls of tissue smoothly

Item	Color	Capacity	Core Diameter	Dimensions H x W x D
CLASSIC STYLE				
R6000*	TBL, TBK	(1) 12" (305 mm) JBT roll	3¼" (83 mm)	14⅞" x 12 ⁹ / ₁₆ " x 5 ⁴ / ₈ " (378 x 328 x 147 mm)

Construction: Impact resistant plastic



Quantum[®] 12"-13" JBT

- Holds one 12"-13" jumbo bath roll and one 6" stub roll
- Continual availability of paper provided by the Infinity System[®], eliminating stub roll waste

Item	Color	Capacity	Core Diameter	Dimensions H x W x D
CLASSIC STYLE				
R6500*	TBL, TBK	(1) 12-13" (305-330 mm) JBT roll (1) 6" (180 mm) stub roll	3¼" (83 mm)	16½" x 22" x 5½" (419 x 559 x 149 mm)

Construction: Impact resistant plastic



* Specify desired color after item number. Example: R4000TBL



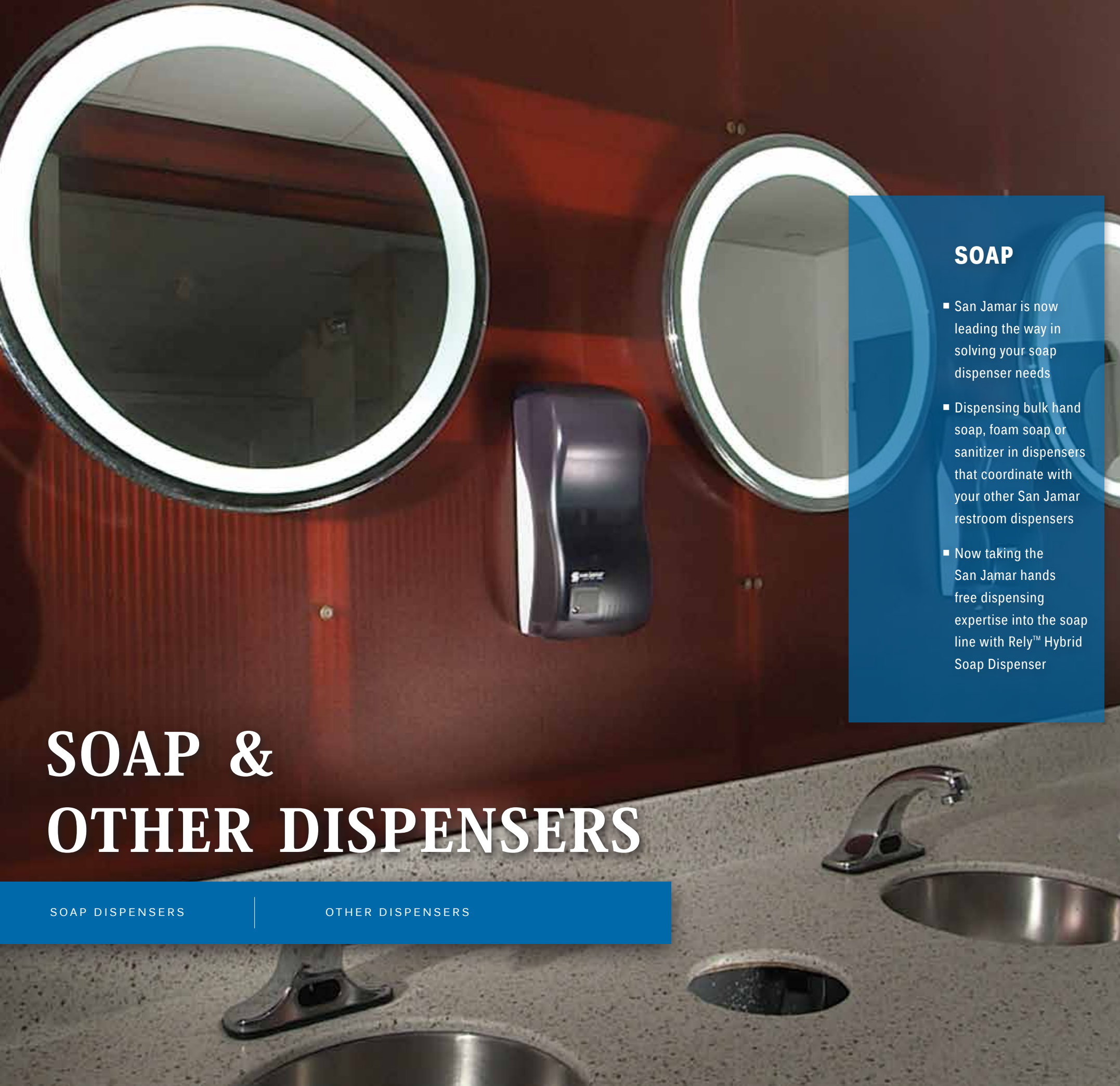

SOAP

- San Jamar is now leading the way in solving your soap dispenser needs
- Dispensing bulk hand soap, foam soap or sanitizer in dispensers that coordinate with your other San Jamar restroom dispensers
- Now taking the San Jamar hands free dispensing expertise into the soap line with Rely™ Hybrid Soap Dispenser

SOAP & OTHER DISPENSERS

SOAP DISPENSERS

OTHER DISPENSERS

Rely™ Hybrid Soap & Sanitizer Dispensers

- Touchless electronic soap & sanitizer dispensing
- Manual "Push-The-Cover" operation when batteries are low
- Accepts bulk hand sanitizers, lotion and foam soap



SHF900TBK

Item	Colors	Capacity	Dimensions H x W x D
LIQUID & LOTION			
SH900*	TBL, TBK	900 ml <i>0.6 ml portion dispensed</i>	12" x 5.5" x 4" (305 x 140 x 102 mm)
FOAM			
SHF900*	TBL, TBK	900 ml <i>0.6 ml portion dispensed</i>	12" x 5.5" x 4" (305 x 140 x 102 mm)

Construction: Impact resistant plastic

Rely™ Manual Soap & Sanitizer Dispensers

- Available in 900 & 1300 capacities
- Accepts bulk hand sanitizers, lotion and foam soap
- Mounts easily with adhesive or screws



SF1300TBK

Item	Colors	Capacity	Dimensions H x W x D
LIQUID & LOTION			
S900*	TBL, TBK	900 ml <i>0.6 ml portion dispensed</i>	8.5" x 5" x 4" (216 x 127 x 102 mm)
S1300*	TBL, TBK	1300 ml <i>0.6 ml portion dispensed</i>	10" x 5" x 4" (254 x 127 x 102 mm)
FOAM			
SF900*	TBL, TBK	900 ml <i>0.6 ml portion dispensed</i>	8.5" x 5" x 4" (216 x 127 x 102 mm)
SF1300*	TBL, TBK	1300 ml <i>0.6 ml portion dispensed</i>	10" x 5" x 4" (254 x 127 x 102 mm)

Construction: Impact resistant plastic

* Specify desired color after item number. Example: SH900TBK



Arctic Blue Black Pearl



S890TBL

S890TBK

Oceans® Soap & Hand Sanitizer Dispensers

- Accommodates bulk or most 800 ml bag-in-box cartridges
- Accepts bulk hand sanitizers or lotion soap
- Mounts easily with adhesive or screws

Item	Colors	Capacity	Dimensions H x W x D
OCEANS® STYLE			
S890*	TBL, TBK	800 ml (can hold some 1000 ml bags) 0.9 ml portion dispensed	10½" x 4½" x 4¾" (267 x 114 x 111 mm)

Construction: Impact resistant plastic

Toilet Seat Cover Dispensers

- Hygienic and cost effective
- Reliable one-at-a-time dispensing

Item	Color	Capacity	Dimensions H x W x D
TS510*	TBL, TBK	(1) Package standard toilet seat covers	11¾" x 17¼" x 3½" (298 x 438 x 79 mm)

Construction: Impact resistant plastic



TS510TBL



S30TBK

Soap Dispensers - Lotion, Liquid or Foam

- Accommodates a wide variety of liquid, lotion (except pumice) and foam soaps
- Large push bar allows for easy dispensing

Item	Color	Capacity	Dimensions H x W x D
LIQUID & LOTION			
S30*	TBL, TBK	30 oz. (0.9 l) 0.8 ml portion dispensed	6½" x 4½" x 4¼" (156 x 105 x 108 mm)
FOAM			
SF30*	TBL, TBK	30 oz. (0.9 l) 0.4 ml portion dispensed	6½" x 4½" x 4¼" (156 x 105 x 108 mm)

Construction: Impact resistant plastic

Glove Dispensers

- Prevent boxes from becoming damaged or contaminated

Item	Color	Capacity	Construction
G0801	Stainless Steel	1 Box	22-gauge stainless steel
G0802	White	1 Box	22-gauge steel with white baked enamel
G0804	White	3 Boxes	22-gauge steel with white baked enamel
G0803	Clear	1 Box	High-grade flexible Plexiglas®
G0805	Clear	3 Boxes	High-grade flexible Plexiglas®

Construction: Impact resistant plastic
Plexiglas® is a registered trademark of Rohm and Haas.



G0801



G0802



G0805



T1730TBK

Handwashing Station Value Pack

- Convenient solution to ensure employees have the tools to properly wash their hands

Item	Includes
T1730TBK	(1) T1700TBK Ultrafold™ Towel Dispenser with handwashing instructions sticker (1) S30TBK Bulk Soap Dispenser

Construction: Impact resistant plastic

* Specify desired color after item number. Example: S30TBL



CHEMICALS

WET WIPES

CHEMICALS

ODOR CONTROL

WET WIPES

- Assure™ Wet Wipes are the premier system for keeping wipes moist, reducing cost-in-use, and preventing pilferage
- The three popular formulas; general purpose cleaning, surface disinfecting and hand sanitizing, are colored-coded for easy identification and can be used almost anywhere

WD1005



WWS1005
Stand sold separately

Assure™ Wet Wipes Dispenser

- Snap-in connection between refill and dispenser
- Patented self-closing dispenser lid to prevent moisture loss**
- Lockable cabinet to prevent theft or vandalism

Item	Description	Dimensions H×W×D
DISPENSER		
WD1005	Assure™ Wet Wipes Dispenser*	10½" x 5¾" x 5½" (267 x 146 x 140 mm)
WWS1005	Assure™ Wet Wipes Stand	54¾" x 18" x 18" (1391 x 457 x 457 mm)

Construction: Impact resistant plastic (dispenser), powder coated steel (stand)

* Must be used with WW1000, WW1001 or WW1002

** Brightwell Patented Modular Wet Wipe Technology

“ We use Assure wipes in our exercise room to wipe down the vinyl padding of equipment. These keep our equipment clean and germ free. The self-closing lid guarantees a moist wipe every time.

~ Mitch D.



Assure™ Wet Wipes**

- Snap-in connection between refill and dispenser
- Patented self-closing dispenser lid to prevent moisture loss***
- Lockable cabinet to prevent theft or vandalism

Item	Description	Quantity	Dimensions H x W x D
WW1000*	Assure™ General Purpose Cleaning Wipes	200 wipes per pouch, 6 pouches per case	9½" x 3½" x 7½" (241 x 89 x 191 mm)
WW1001*	Assure™ Surface Disinfecting Wipes	200 wipes per pouch, 6 pouches per case	9½" x 3½" x 7½" (241 x 89 x 191 mm)
WW1002*	Assure™ Hand Sanitizing Wipes	200 wipes per pouch, 6 pouches per case	9½" x 3½" x 7½" (241 x 89 x 191 mm)

* Must be used with WD1005

** MSDS and label information located at www.sanjamar.com under Wet Wipes Literature

*** Brightwell patented modular wet wipe technology

CHEMICALS

- Specially formulated products for bars, restaurants and institutions
- These value-added products solve unique problems in cleaning equipment, drains and hard surfaces



BluNaturale™

- Natural grit scrubbers clean and polish without scratching
- Super strong cleaner removes dirt, grease, soap scum, rust, food residue, mildew stains and calcium deposits easily
- Leaves a pleasant lemon fragrance after each cleaning

Item	Description	Quantity
CHEM1000	Lemon Grit Cleanser	32 fl. oz. (946 ml)



Saf-T-Ice® Descaler

- Quick removal of lime, scale, hard water deposits, rust stains, and mildew
- Keeps ice machines operating at peak efficiency and lowers energy bills
- Safe to use on most metals including nickel, stainless steel, chrome, plastic and fiberglass

Item	Description	Quantity
SI9800	Industrial Ice Machine Descaler	16 fl. oz. (473 ml)



Saf-T-Drain™

- Bio-enzymatic drain cleaner that leaves a fresh mint fragrance after every dosage
- Effective on beer and soda residue, grease, fats, food waste, hair and scum
- Clinging formula coats drain lines to attack buildup

Item	Description	Quantity
BDR1000	Thickened Bacterial Drain Treatment	32 fl. oz. (946 ml)

Arriba™ Twist Solaire™

- Battery-free fan dispersion
- Solar panels can harvest all forms of indoor lighting
- LED refill notification

Item	Color	Dimensions H x W x D
WS107 80 1207	Gray	7" x 3½" x 3½" (178 x 79 x 89 mm)
WS107 80 1208	White	7" x 3½" x 3½" (178 x 79 x 89 mm)



WS107 80 1208

Arriba™ Twist Fan

- Battery operated model features an intermittent fan
- Sensor activated - will turn off when lights are turned off
- LED refill notification

Item	Color	Dimensions H x W x D
WF107 80 1204	Gray	7" x 3" x 3½" (178 x 76 x 89 mm)
WF107 80 1206	White	7" x 3" x 3½" (178 x 76 x 89 mm)



WF107 80 1206

Requires 2 C-cell alkaline batteries

Arriba™ Twist Passive

- No batteries required
- Simple and silent operation

Item	Color	Dimensions H x W x D
WP107 80 1202	Gray	2⅞" x 4⅝" x 2⅞" (73 x 117 x 73 mm)
WP107 80 1203	White	2⅞" x 4⅝" x 2⅞" (73 x 117 x 73 mm)



WP107 80 1203

Arriba™ Starter Packs

- Continuous 60 day coverage
- Completely recyclable

Item	Fragrance	Description	Dimensions H x W x D
WP1202MB	Mango Burst	(1) WP107 80 1202 (2) RW107 80 1232	8" x 3" x 9" (203 x 76 x 229 mm)
WP1202TW	Tropic Wave	(1) WP107 80 1202 (2) RW107 80 1228	8" x 3" x 9" (203 x 76 x 229 mm)



WP1202MB

ODOR CONTROL ARRIBA™ TWIST AIR CARE

- Arriba Twist System works anywhere you need quality air care and sustainable, earth friendly technology: commercial buildings, restaurants, schools, and healthcare facilities.
- Our dispensers combine an innovative Quickload™ design with a unique Advanced Capillary Science™ (ACS) delivery system to ensure consistent 60-day performance

Arriba™ Twist Fragrances

Item	Fragrance	Quantity
RW107 80 1226	English Garden	2.5 fl. oz. (70 ml)
RW107 80 1227	Pacific Glacier	2.5 fl. oz. (70 ml)
RW107 80 1228	Tropic Wave	2.5 fl. oz. (70 ml)
RW107 80 1230	Citrus Blossom	2.5 fl. oz. (70 ml)



Item	Fragrance	Quantity
RW107 80 1231	Pure Linen	2.5 fl. oz. (70 ml)
RW107 80 1232	Mango Burst	2.5 fl. oz. (70 ml)
RW107 80 1233	Crystal Pure	2.5 fl. oz. (70 ml)
RW107 80 1234	Prairie Flowers	2.5 fl. oz. (70 ml)
RW107 80 1235	French Vineyard	2.5 fl. oz. (70 ml)

ODOR CONTROL SNAP AEROSOL PROGRAMMABLE AIR CARE SYSTEMS

- Patented QuickLoad™ design allows for easy, one-handed refilling as refills snap into place from the bottom of the dispenser
- Automatic refill drops down when refill is empty
- Enhanced LCD/LED programming for superior performance



LC125 80 1804

Arriba™ Snap LCD Dispensers

- Precision LCD Programming with real-time clock for spray interval 12/24 hour operation, days of the week and auto refill drop-down
- Auto-drop down feature automatically drops down when refill is empty

Item	Color	Description	Dimensions H x W x D
LC125 80 1803	Gray	Standard Dispenser	7 ⁷ / ₈ " x 3 ³ / ₈ " x 3 ³ / ₄ " (200 x 98 x 95 mm)
LC125 80 1804	White	Standard Dispenser	7 ⁷ / ₈ " x 3 ³ / ₈ " x 3 ³ / ₄ " (200 x 98 x 95 mm)
CC110 80 1805	Gray	Compact Dispenser	7 ¹ / ₂ " x 3 ³ / ₈ " x 3 ³ / ₄ " (181 x 86 x 76 mm)
CC110 80 1806	White	Compact Dispenser	7 ¹ / ₂ " x 3 ³ / ₈ " x 3 ³ / ₄ " (181 x 86 x 76 mm)

Requires 2 C-cell alkaline batteries



LE125 80 1802

Arriba™ Snap LED Dispensers

- Simplified LED programming with indicator light to provide alerts when it is time to change the batteries or replace refills
- Programming options including spray interval, 24 hour/day/night switch & auto refill drop-down

Item	Color	Description	Dimensions H x W x D
LE125 80 1801	Gray	Standard Dispenser	7 ⁷ / ₈ " x 3 ³ / ₈ " x 3 ³ / ₄ " (198 x 97 x 92 mm)
LE125 80 1802	White	Standard Dispenser	7 ⁷ / ₈ " x 3 ³ / ₈ " x 3 ³ / ₄ " (198 x 97 x 92 mm)

Requires 2 C-cell alkaline batteries

Arriba™ Snap Aerosol Fragrances

- QuickLoad™ - Easy one-handed refill change - push from the bottom and snap into place
- Contains just the right amount of essential oil fragrance
- Both standard and compact size refills hold 3,000 sprays

Item	Fragrance	Description	Quantity
RL125 80 1847	Pacific Glacier	Standard size refill	6.5 oz. (184 g)
RL125 80 1848	Tropical Breeze	Standard size refill	6.5 oz. (184 g)
RL125 80 1849	Oriental Fusion	Standard size refill	6.5 oz. (184 g)
RL125 80 1850	South Pacific	Standard size refill	6.5 oz. (184 g)
RL125 80 1851	Autumn Harvest	Standard size refill	6.5 oz. (184 g)
RL125 80 1852	Mardi Gras	Standard size refill	6.5 oz. (184 g)
RL125 80 1853	Desert Dreams	Standard size refill	6.5 oz. (184 g)
RL125 80 1854	Apple Orchard	Standard size refill	6.5 oz. (184 g)
RL125 80 1855	Morning Mist	Standard size refill	6.5 oz. (184 g)
RL125 80 1856	Mango Burst	Standard size refill	6.5 oz. (184 g)
RL125 80 1857	Powder Fresh	Standard size refill	6.5 oz. (184 g)
RL125 80 1858	Pure Linen	Standard size refill	6.5 oz. (184 g)
RL125 80 1859	Lemon Burst	Standard size refill	6.5 oz. (184 g)

Item	Fragrance	Description	Quantity
RC110 80 1865	Pacific Glacier	Compact size refill	2.5 oz. (71 g)
RC110 80 1866	Tropical Breeze	Compact size refill	2.5 oz. (71 g)
RC110 80 1867	Oriental Fusion	Compact size refill	2.5 oz. (71 g)
RC110 80 1868	South Pacific	Compact size refill	2.5 oz. (71 g)
RC110 80 1869	Autumn Harvest	Compact size refill	2.5 oz. (71 g)
RC110 80 1870	Mardi Gras	Compact size refill	2.5 oz. (71 g)
RC110 80 1871	Desert Dreams	Compact size refill	2.5 oz. (71 g)
RC110 80 1872	Apple Orchard	Compact size refill	2.5 oz. (71 g)
RC110 80 1874	Morning Mist	Compact size refill	2.5 oz. (71 g)



COUNTER SERVICE

At San Jamar, innovation and quality come to the forefront when our customers demand solutions to counter service management. One-at-a-time dispensing of cups, lids and napkins is essential when managing costs. As a trusted partner, we are always there to help our customers have a smart, safe and sanitary operation - all provided in the most cost effective way.



NAPKIN
DISPENSERS

CUP & LID
DISPENSERS

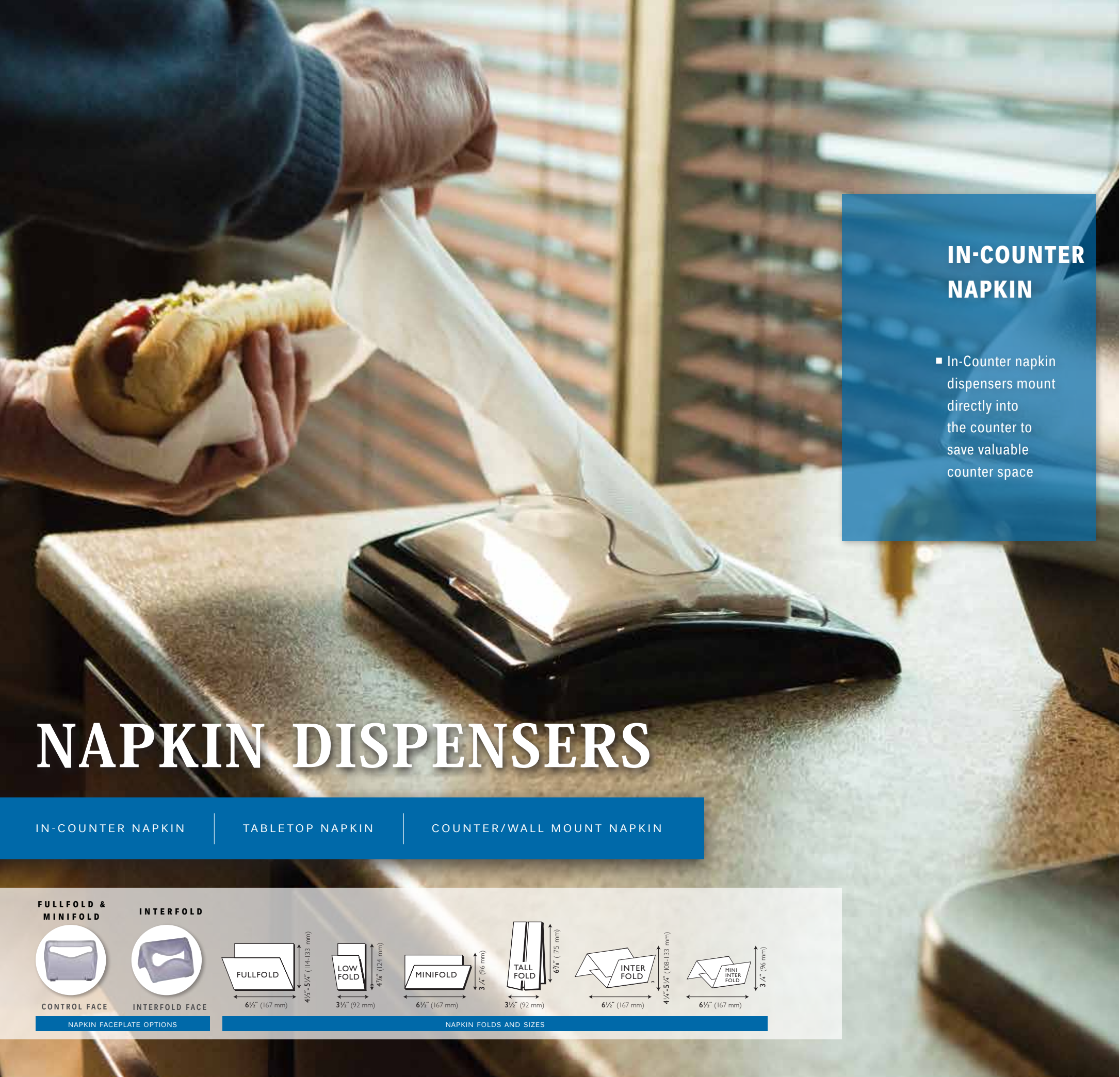

IN-COUNTER NAPKIN

- In-Counter napkin dispensers mount directly into the counter to save valuable counter space

NAPKIN DISPENSERS

IN-COUNTER NAPKIN

TABLETOP NAPKIN

COUNTER/WALL MOUNT NAPKIN



CONTROL FACE



INTERFOLD FACE

NAPKIN FACEPLATE OPTIONS

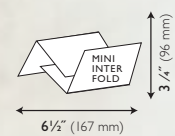
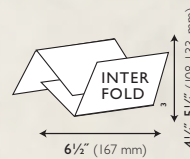
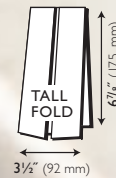
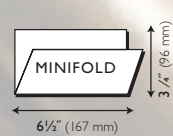
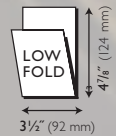
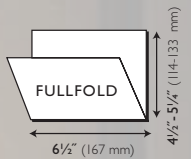

NAPKIN FOLDS AND SIZES

Venue® In-Counter Napkin Dispensers

- Control face restricts napkin usage, saving up to 30%
- High capacity, holds over 750 napkins
- Ability to convert easily for variety of napkin types
- Adapter allows dispenser to fit into existing counter hole cutouts

Item	Color	Type	Capacity	Dimensions H x W x D
H2005CLBK	CLBK	Fullfold/Control Face	750+	20" x 7 1/8" x 8 1/8" (507 x 184 x 224 mm)
H2003CLBK	CLBK	Interfold	750+	20 3/8" x 7 1/8" x 8 1/8" (518 x 184 x 224 mm)
H2003CLBK12	CLBK	Interfold	450+	12" x 7 1/8" x 8 1/8" (305 x 184 x 224 mm)
H2003CLSC	CLBK	Interfold	750+	20 3/8" x 7 1/8" x 8 1/8" (518 x 184 x 224 mm)
H2005SC	SC	Fullfold/Control Face	750+	20" x 7 1/8" x 8 1/8" (507 x 184 x 224 mm)
H2005CLSC	CLSC	Fullfold/Control Face	750+	20" x 7 1/8" x 8 1/8" (507 x 184 x 224 mm)

ADAPTER		
H200ADT	In-Counter Napkin Adapter to be used with existing counter hole range of: 7.5" (189 mm) to 7.625" (194 mm) W by 5.400" (137 mm) to 5.825" (148 mm) L	8 3/16" x 6 3/8" x 3" (207 x 168 x 75 mm)

Construction: (Face) ABS plastic; (Body) 22-gauge stainless steel

“ We used small napkins on our tables and went through tons. Now we have greater control and lower costs, I highly recommend this to anyone with a restaurant.

~ Brandon Z.

Code	Face	Frame
CLBK	Clear	Black
SC	Satin Chrome	Satin Chrome
CLSC	Clear	Satin Chrome



H2005CLSS

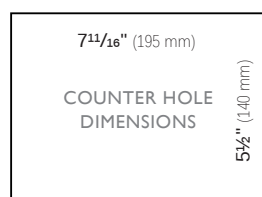

TABLETOP NAPKIN

- Control and Interfold faceplates provide one-at-a-time dispensing to reduce napkin waste by 30%

Venue® Tabletop Napkin Dispenser

- Includes advertising insert space for in-house promotion
- Available with or without caddy
- Compact design



H4005CTBK

Item	Color	Type	Capacity	Dimensions H x W x D
H4000TBK	TBK	Minifold	200+	4 7/8" x 7 1/2" x 6 1/4" (124 x 191 x 159 mm)
H4003TBK	TBK	Interfold	200+	6 3/4" x 7 1/2" x 6 3/8" (159 x 191 x 156 mm)
H4004TBK	TBK	Mini Interfold	200-250	4 7/8" x 7 1/2" x 6 1/4" (124 x 191 x 159 mm)
H4005TBK	TBK	Fullfold/Control face	200+	6 3/4" x 7 1/2" x 6 3/8" (159 x 191 x 156 mm)
H4006TBK	TBK	Compact Interfold	200+	6 3/8" x 5 1/2" x 5 1/4" (161 x 130 x 132 mm)
H4005CTBK	TBK	Fullfold Dispenser & Caddy	200+	6 3/4" x 14 1/4" x 6 3/8" (159 x 362 x 156 mm)
H400CTBK	TBK	Caddy only	N/A	2 3/4" x 14 1/4" x 6 3/8" (70 x 362 x 156 mm)

Construction: Impact resistant plastic



In-Counter Napkin Dispensers

- Space saving design for under the counter provides a neat, professional appearance
- Durable
- One-at-a-time dispensing of napkins

Item	Color	Type	Capacity	Dimensions H x W x D
H2000*	XC, SS, SC	Minifold	750+	19 5/8" x 7" x 5 1/2" (498 x 178 x 140 mm)
H2001*	XC, SS, CLSS, SC	Fullfold/Classic Face	750+	19 5/8" x 7" x 5 1/2" (498 x 178 x 140 mm)
H2005CLSS	CLSS	Fullfold/Control Face	750+	19 5/8" x 7" x 5 1/2" (498 x 178 x 140 mm)
H2003CLSS	CLSS	Interfold	750+	19 5/8" x 7" x 5 1/2" (498 x 178 x 140 mm)
H2003CLSS12	CLSS	Interfold	450+	13 3/4" x 7" x 5 1/2" (349 x 178 x 140 mm)

Construction: (Face) 18-gauge steel and ABS plastic; (Body) 22-gauge stainless steel

Code	Face	Frame
XC	Chrome	Chrome
CLSS	Clear	Stainless Steel
SS	Stainless Steel	Stainless Steel
SC	Satin Chrome	Satin Chrome

Tabletop Napkin Dispensers

- Two-sided dispensing for easy accessibility

Item	Color	Type	Capacity	Dimensions H x W x D
22-GAUGE STAINLESS STEEL				
H900*	BK, XC	Tallfold	150+	7 1/2" x 3 3/4" x 4" (191 x 95 x 102 mm)
H985*	BK, X	Lowfold	150+	5 1/2" x 3 3/4" x 4" (140 x 95 x 102 mm)
HEAVY GAUGE STEEL				
H4000	XC	Minifold	170+	4 1/2" x 7 3/4" x 6" (114 x 197 x 152 mm)
H4001XC	XC	Fullfold	170+	5 3/4" x 7 3/4" x 6" (146 x 197 x 152 mm)
IMPACT RESISTANT PLASTIC				
H950TBK	TBK	Compact Lowfold	150+	5 3/5" x 3 9/10" x 5 1/20" (142 x 100 x 129 mm)



* Specify desired color after item number. Example: H2000XC

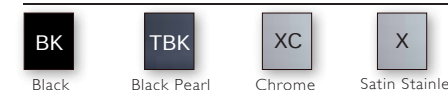

COUNTER/ WALL MOUNT NAPKIN

- San Jamar's Venue® napkin dispensers offer optimal dispensing for a variety of napkin sizes including Minifold, Fullfold, and Interfold napkins
- Stackable countertop dispensers save room on your countertop and the unique Wall Mount Venue is ideal where space is limited



H5005CL

Venue® Countertop Napkin Dispenser

- Stackable design to save counter space
- One-at-a-time dispensing to save napkin waste
- Smooth dispensing down to the last napkin

Item	Color	Type	Capacity	Dimensions H x W x D
H5000*	CL, TBK	Minifold/Control Face	450+	5 ⁷ / ₈ " x 8" x 15 ³ / ₄ " (149 x 203 x 400 mm)
H5003*	CL, TBK	Interfold	550+	7 ¹ / ₄ " x 8" x 15 ³ / ₄ " (184 x 203 x 400 mm)
H5004*	CL, TBK	Mini Interfold	550+	5 ⁷ / ₈ " x 8" x 15 ³ / ₄ " (149 x 203 x 400 mm)
H5005*	CL, TBK	Fullfold/Control Face	450+	7 ¹ / ₄ " x 8" x 15 ³ / ₄ " (184 x 203 x 400 mm)

Construction: Impact resistant plastic



H50005STBK

Venue® Napkin Dispenser with Stand

- Stand model enhances image and saves counter space
- One-at-a-time dispensing to save napkin waste
- Smooth dispensing down to the last napkin

Item	Color	Type	Capacity	Dimensions H x W x D
H5000S*	CL, TBK	Minifold/Control Face	450+	17 ¹ / ₄ " x 8" x 13" (440 x 203 x 330 mm)
H5005S*	CL, TBK	Fullfold/Control Face	450+	7 ¹ / ₂ " x 8" x 13" (445 x 203 x 330 mm)

Construction: Impact resistant plastic



Venue® Wall Model Napkin Dispenser

- Mount to the wall to save valuable counter space
- One-at-a-time dispensing to save napkin waste
- Smooth dispensing down to the last napkin

Item	Color	Type	Capacity	Dimensions H x W x D
H5000P*	CL, TBK	Minifold/Control Face	500+	15 ³ / ₄ " x 8" x 5 ⁹ / ₁₀ " (400 x 203 x 150 mm)
H5003P*	CL, TBK	Interfold	500+	15 ³ / ₄ " x 8" x 7 ¹ / ₄ " (400 x 203 x 184 mm)
H5004P*	CL, TBK	Mini Interfold	500+	15 ³ / ₄ " x 8" x 5 ⁹ / ₁₀ " (400 x 203 x 150 mm)
H5005P*	CL, TBK	Fullfold/Control Face	500+	15 ³ / ₄ " x 8" x 7 ¹ / ₄ " (400 x 203 x 184 mm)

Construction: Impact resistant plastic



H5005PCL

Countertop Napkin Dispensers

Item	Color	Type	Capacity	Dimensions H x W x D
H3001*	XC, BKC, CLBK, CLXC, TBK BK	Fullfold	300+	5 ¹ / ₂ " x 7 ⁵ / ₈ " x 11" (140 x 194 x 279 mm)
H3005CLXC	CLXC	Fullfold/Control Face	300+	5 ¹ / ₂ " x 7 ⁵ / ₈ " x 11" (140 x 194 x 279 mm)

Construction: (Face) 18-gauge steel or poly carbonate plastic (Body) 20-gauge steel; (Base) high-impact plastic



H3001CLBK



H3005CLXC

* Specify desired color after item number. Example: H900BK

FACE	TBK	CL	SS	BODY	XC	BK
	Black Pearl	Clear	Satin Stainless		Chrome	Black

Code	Face	Body
CLBK	Clear	Black
CLXC	Clear	Chrome
TBK BK	Black Pearl	Black
BKC	Chrome	Black
XC	Chrome	Chrome



CUP & LID DISPENSERS

CUP & LID SYSTEMS | IN-COUNTER CUP | SURFACE MOUNT CUP | LID & STRAW

CUP & LID SYSTEMS

Sentry® Dispenser cabinets offer:

- Simple adjustment of Lifetime Levers provide quick, easy one-at-a-time dispensing
- Easy changes of cup sizes and types
- No misplaced or replaceable parts

EZ-Fit® Dispenser cabinets offer:

- Interchangeable gaskets that allow for cup sizes and types to be changed easily
- One-at-a-time dispensing
- Replaceable gaskets



Sentry® Beverage Dispenser Cabinets

- No wear parts to replace
- Adjustable Lifetime Levers prevent marring of cups
- Dispenses paper, plastic and foam cups one-at-a-time

Item	Includes	Dimensions H x W x D
C2951BK	(1) C5450C black trim ring	7¾" x 7¾" x 23¾" (197 x 197 x 604 mm)
C2952BK	(2) C5450C black trim rings	15½" x 7¾" x 23¾" (384 x 197 x 604 mm)
C2953BK	(3) C5450C black trim rings	24¾" x 7¾" x 23¾" (568 x 197 x 604 mm)

Construction: Black polystyrene



“ This is exactly what I needed. The best feature is you can load from the top, so you don’t need to have access to the bottom. There are tabs that hold the cups in place, they are adjustable and can be set to almost any size. ”

~ Pete S.



L22CS2951BK

Sentry® Beverage & Lid Dispenser Cabinets

- No wear parts to replace
- Adjustable Lifetime Levers™ prevent marring of cups
- Dispenses paper, plastic and foam cups one-at-a-time

Item	Includes	Dimensions H x W x D
BEVERAGE, LID & STRAW CABINET		
L22CS2951BK	(1) C5450C, (1) L2200C, (1) straw compartment, black trim rings	22 ³ / ₈ " x 7 ³ / ₄ " x 25 ³ / ₈ " (568 x 197 x 645 mm)
BEVERAGE & LID CABINETS		
L22C2951BK	(1) C5450C, (1) L2200C, black trim rings	15 ¹ / ₈ " x 7 ³ / ₄ " x 25 ³ / ₈ " (384 x 197 x 645 mm)
L24C2951BK	(1) C5450C, (1) L2400C, black trim rings	15 ¹ / ₈ " x 7 ³ / ₄ " x 25 ³ / ₈ " (384 x 197 x 645 mm)

Construction: Black polystyrene



C2852

C2853

C2854

Sentry® Stainless Steel Beverage Dispenser Cabinets

Item	Includes	Dimensions H x W x D
C2852	(2) C5450C	16" x 8 ¹ / ₂ " x 24 ³ / ₈ " (406 x 206 x 619 mm)
C2853	(3) C5450C	24 ³ / ₈ " x 8 ¹ / ₂ " x 24 ³ / ₈ " (616 x 206 x 619 mm)
C2854	(4) C5450C	30 ³ / ₄ " x 8 ¹ / ₂ " x 24 ³ / ₈ " (768 x 206 x 619 mm)

Construction: 22-gauge stainless steel



EZ-Fit® Beverage Dispenser Cabinets

Item	Includes	Dimensions H x W x D
C2901	(1) C2410C with metal finish trim ring	7 ³ / ₄ " x 7 ³ / ₄ " x 23 ³ / ₄ " (197 x 197 x 603 mm)
C2901BK	(1) C2410C with black trim ring	7 ³ / ₄ " x 7 ³ / ₄ " x 23 ³ / ₄ " (197 x 197 x 603 mm)
C2902	(2) C2410C with metal finish trim rings	15" x 7 ³ / ₄ " x 23 ³ / ₄ " (381 x 197 x 603 mm)
C2902BK	(2) C2410C with black trim rings	15" x 7 ³ / ₄ " x 23 ³ / ₄ " (381 x 197 x 603 mm)
C2903	(3) C2410C with metal finish trim rings	22 ³ / ₈ " x 7 ³ / ₄ " x 23 ³ / ₄ " (568 x 197 x 603 mm)
C2903BK	(3) C2410C with black trim rings	22 ³ / ₈ " x 7 ³ / ₄ " x 23 ³ / ₄ " (568 x 197 x 603 mm)

Construction: Black polystyrene



C2901

C2902

C2903

EZ-Fit® Stainless Steel Beverage Dispenser Cabinets

Item	Includes	Dimensions H x W x D
C2802	(2) C2410C	16" x 8 ¹ / ₂ " x 24 ³ / ₈ " (406 x 205 x 619 mm)
C2803	(3) C2410C	24 ³ / ₈ " x 8 ¹ / ₂ " x 24 ³ / ₈ " (619 x 205 x 629 mm)
C2804	(4) C2410C	30 ³ / ₄ " x 8 ¹ / ₂ " x 24 ³ / ₈ " (768 x 205 x 619 mm)

Construction: 22-gauge stainless steel



C2804

C2803

Portion Cup Box System

Item	Includes	Dimensions H x W x D
C9002	(2) C2010C Portion Cup	10 ¹ / ₁₆ " x 5 ¹ / ₁₆ " x 13" (256 x 129 x 330 mm)

Construction: 22-gauge stainless steel



C9002



C8503WFD

C8504WFD with all accessories

Wireworks™ Cup Dispenser & Lid Organizer

- Lowest cost option for dispensing paper, plastic or foam cups one-at-a-time
- Coils adjust to fit cups ranging from 8-44 ounces
- Available with side panels to prevent contamination

Item	Description	Dimensions H x W x D
BASIC UNIT		
C8503WF	(2) cup dispensers, (1) lid organizer	19¾" x 6¾" x 18¼" (492 x 162 x 464 mm)
C8504WF	(3) cup dispensers, (1) lid organizer	24¾" x 6¾" x 18¼" (620 x 162 x 464 mm)
INCLUDES SIDE PANELS		
C8503WFD	(2) cup dispensers, (1) lid organizer, (2) side panels	19¾" x 6¾" x 18¼" (492 x 162 x 464 mm)
C8504WFD	(3) cup dispensers, (1) lid organizer, (2) side panels	24¾" x 6¾" x 18¼" (620 x 162 x 464 mm)
ACCESSORIES		
X101924	Spindle for domed lids	
X101987	(2) Spindle set for domed lids	
C8500S	Straw organizer kit (cup and caddy)	

Construction: Black epoxy-coated steel

Cup & Lid Wire Organizers

- Economically organizes all types of beverage cups/lids
- Anti-slip feet keeps unit in place
- Includes straw caddy



C8003WFS

Item	Includes	Dimensions H x W x D
C8003WFS	3 stacks	8½" x 17½" x 5¼" (216 x 435 x 133 mm)
C8005WFS	5 stacks	8½" x 27½" x 5¼" (216 x 435 x 133 mm)

Construction: 4 and 5 mm black epoxy-coated steel wire

Cup & Lid Dispenser Kit & Stand

- Countertop alternative to organize a variety of wall mount cup and lid dispensers
- Holds up to four San Jamar cup/lid dispensers in any configuration

Item	Includes	Description	Dimensions H x W x D
C3620	Kit: C3604, L3402, C3200P, C3400P	Each stand will hold up to four San Jamar cup or lid dispensers in any configuration	36" x 12" x 12" (914 x 305 x 305 mm)
C3604	Stand only		Base: 10" diameter (254 mm)

Construction: (C3604) Chrome-plated steel; (C3200P, C3400P) 26-gauge stainless steel; (L3402) 22-gauge stainless steel



C3604

C3620

IN-COUNTER CUP

San Jamar's In-Counter cup dispensers:

- Maximize counter space
- Dispense paper, plastic and foam cups
- Provide one-at-a-time dispensing of a wide variety of cup sizes
- Allows for cup size changes without changing dispensers

Sentry® In-Counter Adjustable Cup Dispenser

- No wear parts to replace
- Adjustable Lifetime Levers prevent marring of cups and provide one-at-a-time dispensing
- Dispenses paper, plastic and foam cups one-at-a-time

Item	Cup Rim Diameter	Approx. Cup Size	Counter Hole Diam.	Tube Length
C5450C	3½" - 4½" (79-114 mm)	8-44 oz. (236-1301 ml)	5¼" (134 mm)	23½" (597 mm)
C5450C18	3½" - 4½" (79-114 mm)	8-44 oz. (236-1301 ml)	5¼" (134 mm)	18" (457 mm)

Construction: High-impact plastic

Note: For multiple in-counter units leave a 7¼" (184 mm) space between each unit.



C5450C



Euro Sentry® In-Counter Cup Dispenser

- Smaller footprint than standard Sentry® dispenser
- No wear parts to replace
- Adjustable Lifetime Levers prevent marring of cups and provide one-at-a-time dispensing

Item	Cup Rim Diameter	Approx. Cup Size	Counter Hole Diam.	Tube Length
C5250C	27/16" - 35/8" (62-92 mm)	4-24 oz. (118-710 ml)	45/8" (124 mm)	23½" (597 mm)
C5250C18	27/16" - 35/8" (62-92 mm)	4-24 oz. (118-710 ml)	45/8" (124 mm)	18" (457 mm)

Construction: High-impact plastic

Note: For multiple in-counter units leave a 6¼" (159 mm) space between each unit.



C5250C



One-Size-Fits-All EZ-Fit®

- Includes a gasket pack to handle wide range of cup sizes
- Easily change cup sizes without having to change dispenser
- Dispenses paper, plastic and foam cups one-at-a-time

Item	Cup Rim Diameter	Approx. Cup Size	Counter Hole Diam.	Tube Length
C2410C	27/8" - 4¾" (73-121 mm)	8-46 oz. (236-1360 ml)	5¾" (146 mm)	23¾" (590 mm)
C2410C18	27/8" - 4¾" (73-121 mm)	8-46 oz. (236-1360 ml)	5¾" (146 mm)	18" (457 mm)
C2410CBK (Black Gasket)	27/8" - 4¾" (73-121 mm)	8-46 oz. (236-1360 ml)	5¾" (146 mm)	23¾" (590 mm)

Construction: High-impact plastic

Note: For multiple in-counter units leave a 7¼" (181 mm) space between each unit.



C2410C





C2210C

Euro EZ-Fit®

- Smaller footprint than standard EZ-Fit® dispenser

Item	Cup Rim Diameter	Approx. Cup Size	Counter Hole Diam.	Tube Length
C2210C	2 7/8" - 3 3/8" (73-98 mm)	6-24 oz. (178-710 ml)	4 7/8" (124 mm)	23 1/4" (590 mm)
C2210C18	2 7/8" - 3 3/8" (73-98 mm)	6-24 oz. (178-710 ml)	4 7/8" (124 mm)	18" (457 mm)

Construction: High-impact plastic

Note: For multiple in-counter units leave a 6 1/4" (159 mm) space between each unit.

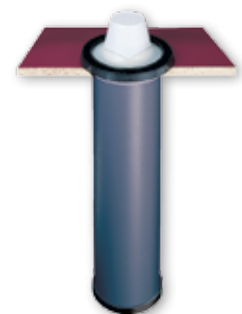

C2510C

Large Deli Cup EZ-Fit®

- Largest capacity EZ-Fit® dispenser

Item	Cup Rim Diameter	Approx. Cup Size	Counter Hole Diam.	Tube Length
C2510C	4 7/8" - 5 5/8" (124-143 mm)	32-64 oz. (950-1890 ml)	6 5/8" (168 mm)	22 1/2" (572 mm)

Construction: High-impact resistant plastic

Note: For multiple in-counter units leave a 8 3/4" (222 mm) space between each unit.

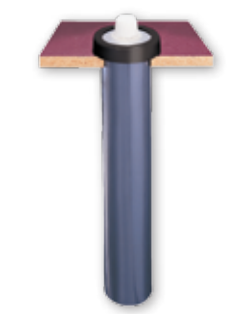

C2010C

Portion Cup EZ-Fit®

- Smallest capacity EZ-Fit® dispenser

Item	Cup Rim Diameter	Approx. Cup Size	Counter Hole Diam.	Tube Length
C2010C	1 1/2" - 2 5/16" (38-59 mm)	1/2-2 1/2 oz. (15-70 ml)	3 1/4" (83 mm)	16" (406 mm)

Construction: High-impact resistant plastic

Note: For multiple in-counter units leave a 4 1/2" (114 mm) space between each unit.

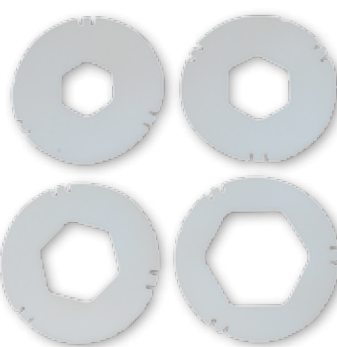

XC2426

EZ-Fit Cup Dispenser Gaskets

- Smallest capacity EZ-Fit® dispenser

Item	Description	Quantity
XC2426	C2410C EZ-Fit Dispenser Gaskets	(Pack of 4 - S, M, L, XL)
XC2426BK	C2410C EZ-Fit Dispenser Black Gaskets	(Pack of 4 - S, M, L, XL)
XC2226	C2210C Euro EZ-Fit Dispenser Gaskets	(Pack of 4 - S, M, L, XL)
XC2226BK	C2210C Euro EZ-Fit Dispenser Black Gaskets	(Pack of 4 - S, M, L, XL)
XC2526	C2510C Deli Cup Dispenser New Style Gaskets	(Pack of 3 - S, M, L)
XC2022	C2010C Portion Cup Dispenser Gaskets	(Pack of 4 - S, M, L, XL)
C2400350	C2410C EZ-Fit Dispenser 3.5" Fixed Rim Insert	1 each
C2400363	C2410C EZ-Fit Dispenser 3.625" Fixed Rim Insert	1 each
C2400368	C2410C EZ-Fit Dispenser 3.68" Fixed Rim Insert	1 each
C2400413	C2410C EZ-Fit Dispenser 4.125" Fixed Rim Insert	1 each
C2400450	C2410C EZ-Fit Dispenser 4.5" Fixed Rim Insert	1 each

EZ-Fit® Metal Finish Rings

Item	Description
C22XC	For C2210C
C24XC	For C2410C



Sentry® Metal Finish Rings

Item	Description
C52XC	For C5250C
C54XC	For C5450C



HOW TO CHOOSE MY STAINLESS STEEL COUNTER MOUNT CUP DISPENSER

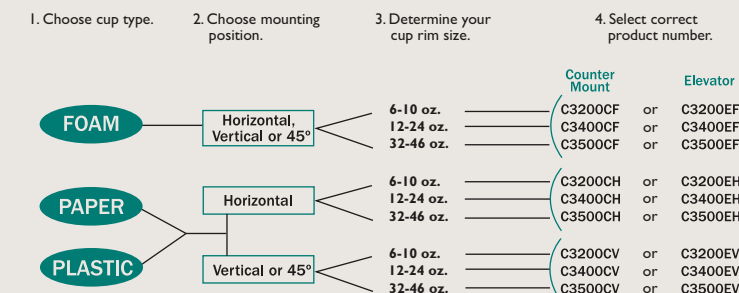

Stainless Steel Counter-Mount Beverage Cup

- Dispenses paper, plastic and foam cups one-at-a-time
- Durable

Item	Cup Rim Diameter	Approx. Cup Size	Counter Hole Diam.	Tube Length
C3200CF C3200CH C3200CV	2 7/32" - 3 3/16" (56-81 mm)	6-10 oz. (177-300 ml)	4 3/16" (106 mm)	23 1/2" (597 mm)
C3400CF C3400CH C3400CV	2 3/4" - 3 3/8" (70-98 mm)	12-24 oz. (350-710 ml)	4 11/16" (119 mm)	23 1/2" (597 mm)
C3500CF C3500CH C3500CV	4" - 4 7/8" (101-124 mm)	32-46 oz. (950-1360 ml)	5 3/4" (106 mm)	23 1/2" (597 mm)



C3500CV C3400CV C3200CV

Construction: 26-gauge stainless steel; 18" tube length available upon request

SURFACE MOUNT CUP

- Ideal for under counter, wall mount, or end cap applications
- Can be mounted horizontally, vertically or at a 45° angle
- Adjustable collar easily conforms to each cup size, ensuring one-at-a-time dispensing without damaging cups

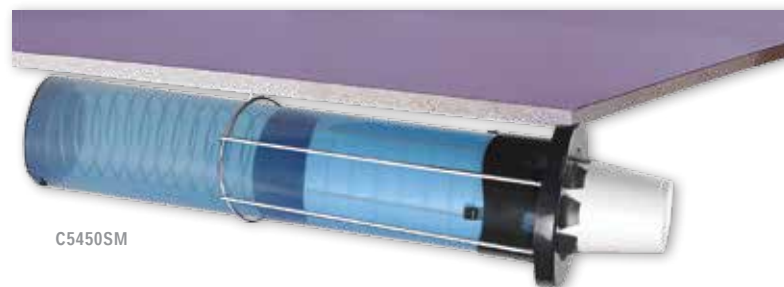

C5450SM

Sentry® Surface Mount Adjustable Cup Dispenser

- No wear parts to replace
- Adjustable Lifetime Levers prevent marring of cups
- Dispenses paper, plastic and foam cups one-at-a-time

Item	Cup Rim Diameter	Approx. Cup Size	Tube Length
C5250SM	2 ⁷ / ₁₆ " - 3 ⁵ / ₁₆ " (62-92 mm)	4-24 oz. (118-710 ml)	18" (457 mm)
C5450SM	3 ¹ / ₈ " - 4 ¹ / ₂ " (79-114 mm)	8-44 oz. (236-1301 ml)	23 ³ / ₄ " (604 mm)

Construction: (Tube) high-impact plastic; (Wire Form) 6-gauge plated wire

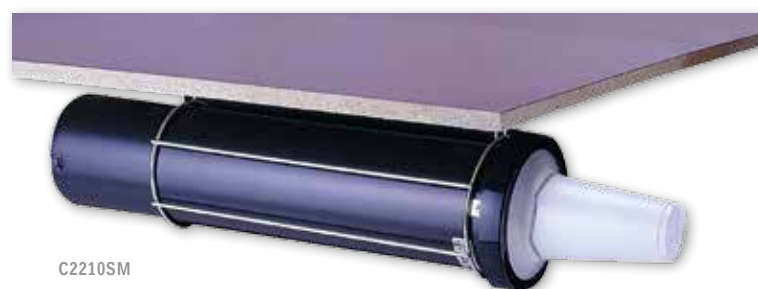

C2210SM

Surface-Mount EZ-Fit®

- Includes a gasket pack to handle a wide range of cup sizes
- Easily change cup sizes without having to change dispenser
- Dispenses paper, plastic and foam cups one-at-a-time

Item	Cup Rim Diameter	Approx. Cup Size	Tube Length
C2210SM	2 ⁷ / ₈ " - 3 ⁷ / ₈ " (73-98 mm)	6-24 oz. (177-710 ml)	18" (457 mm)
C2410SM	2 ⁷ / ₈ " - 4 ³ / ₄ " (73-121 mm)	8-46 oz. (236-1360 ml)	23 ³ / ₄ " (590 mm)

Construction: (Tube) high-impact plastic; (Wire Form) 6-gauge plated wire



HOW TO CHOOSE MY STAINLESS STEEL SURFACE MOUNT CUP DISPENSER

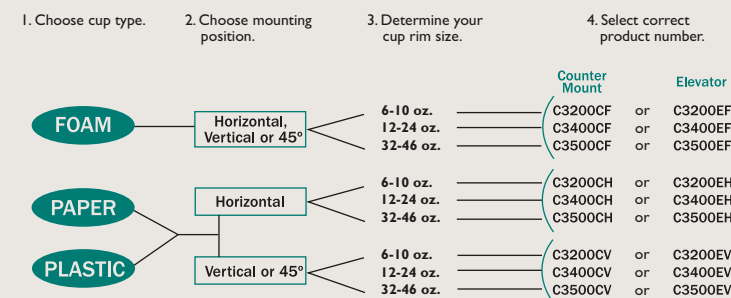

Stainless Steel Surface-Mount (Elevator) Beverage Cup

- Dispenses paper, plastic and foam cups one-at-a-time
- Durable

Item	Cup Rim Diameter	Approx. Cup Size	Tube Length
C3200EF C3200EH C3200EV	2 ⁷ / ₈ " - 3 ³ / ₁₆ " (56-81 mm)	6-10 oz. (177-300 ml)	23 ³ / ₄ " (604 mm)
C3400EF C3400EH C3400EV	2 ³ / ₄ " - 3 ⁷ / ₈ " (70-98 mm)	12-24 oz. (350-710 ml)	23 ³ / ₄ " (604 mm)
C3500EF C3500EH C3500EV	4" - 4 ⁷ / ₈ " (101-124 mm)	32-46 oz. (950-1360 ml)	23 ³ / ₄ " (604 mm)

Construction: 26-gauge stainless steel



C3200EV C3400EV C3500EV

Stainless Steel Pull-Type Beverage Cup

- Dispenses paper, plastic and foam cups one-at-a-time
- Durable

Item	Cup Rim Diameter	Approx. Cup Size	Tube Length
C3200P	2 ⁷ / ₈ " - 3 ³ / ₁₆ " (56-81 mm)	6-10 oz. (177-300 ml)	23 ¹ / ₂ " (597 mm)
C3400P	2 ³ / ₄ " - 3 ⁷ / ₈ " (70-98 mm)	12-24 oz. (350-710 ml)	23 ¹ / ₂ " (597 mm)
C3500P	4" - 4 ⁷ / ₈ " (101-124 mm)	32-46 oz. (950-1360 ml)	23 ¹ / ₂ " (597 mm)

Construction: 26-gauge stainless steel



C3200P C3400P C3500P

Small Pull-Type Water Cup



C4150SS C4160WH C4160TBL

Item	Colors	Cup Rim Diameter	Approx. Cup Size	Tube Length
CONSTRUCTION: 26-GAUGE STAINLESS STEEL				
C4150SS	SS	2¼"-2⅞" (57-73 mm)	Cone 3-4½ oz. (90-130 ml) Flat 3-5 oz. (90-150 ml)	16" (406 mm)
CONSTRUCTION: HIGH-IMPACT RESISTANT PLASTIC				
C4160*	WH, TBL	2¼"-2⅞" (57-73 mm)	Cone 3-4½ oz. (90-130 ml) Flat 3-5 oz. (90-150 ml)	16" (406 mm)

Small Pull-Type Water Cup with Throat

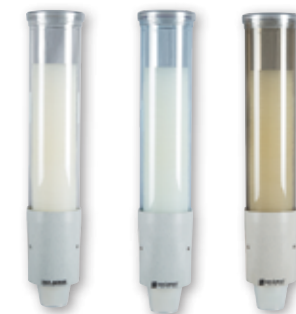

C4180CL C4180TBL C4180TBR

Item	Colors	Cup Rim Diameter	Approx. Cup Size	Tube Length
CONSTRUCTION: HIGH-IMPACT RESISTANT PLASTIC				
C4180*	TBR, TBL, TBLW, CL	2¼"-2⅞" (57-73 mm)	Cone 3-4½ oz. (90-130 ml) Flat 3-5 oz. (90-150 ml)	16" (406 mm)

Note: TBLW = Arctic Blue with White Flip Cap Includes flip cap to allow refilling without removing cap

Medium Pull-Type Water Cup



C3165WH C3165FBL C3165TBL

Item	Colors	Cup Rim Diameter	Approx. Cup Size	Tube Length
CONSTRUCTION: HIGH-IMPACT RESISTANT PLASTIC				
C3165*	WH, TBL, FBL	2½"-3¼" (64-83 mm)	Cone 4-10 oz. (120-300 ml) Flat 4-10 oz. (120-300 ml)	16" (406 mm)

Includes flip cap to allow refilling without removing cap

Large Pull-Type Water Cup



C3450SS C3260TBR C3260TBL

Item	Colors	Cup Rim Diameter	Approx. Cup Size	Tube Length
CONSTRUCTION: 26-GAUGE STAINLESS STEEL				
C3250SS	SS	2¾"-3⅞" (70-86 mm)	Cone 4½-7 oz. (130-210 ml) Flat 6-12 oz. (180-350 ml)	16" (406 mm)
C3450SS	SS	3¼"-3⅞" (82-98 mm)	Cone 8-12 oz. (240-350 ml) Flat 12-24 oz. (350-710 ml)	16" (406 mm)
CONSTRUCTION: HIGH-IMPACT RESISTANT PLASTIC				
C3260*	TBR, TBL	2¾"-3⅞" (70-86 mm)	Cone 4½-7 oz. (130-210 ml) Flat 6-12 oz. (180-350 ml)	16" (406 mm)

Pull-Type Foam Beverage Cup



C4210PFSD C4400PF

Item	Colors	Cup Rim Diameter	Approx. Cup Size	Tube Length
CONSTRUCTION: HIGH-IMPACT POLYETHYLENE				
C4210PFSD	SD	2¾"-3⅞" (70-85 mm)	4-10 oz. (120-300 ml)	23½" (597 mm)
C4410PFSD	SD	3¼"-3⅞" (82-98 mm)	12-24 oz. (350-710 ml)	23½" (597 mm)
CONSTRUCTION: 26-GAUGE STAINLESS STEEL				
C4200PF	SS	2¾"-3⅞" (70-85 mm)	4-10 oz. (120-300 ml)	23½" (597 mm)
C4400PF	SS	3¼"-3⅞" (82-98 mm)	12-24 oz. (350-710 ml)	23½" (597 mm)
C4500PF	SS	3⅞"-4⅞" (98-124 mm)	32-46 oz. (950-1360 ml)	23½" (597 mm)

Pull-Type Paper/Plastic Beverage Cup



C4210PRD

Item	Colors	Cup Rim Diameter	Approx. Cup Size	Tube Length
C4210PRD	RD	2½"-3¼" (64-83 mm)	4-10 oz. (120-300 ml)	23½" (597 mm)
C4410PRD	RD	3⅞"-3⅞" (85-98 mm)	12-24 oz. (350-710 ml)	23½" (597 mm)

Construction: High Impact resistant polyethylene

Adjustable Portion Cup Dispensers



C3000EWH C3000PSS

Item	Colors	Cup Rim Diameter	Approx. Cup Size	Tube Length
CONSTRUCTION: HIGH-IMPACT WHITE POLYETHYLENE				
C3000EWH	WH	1¾"-2½" (44-64 mm)	1¾"-4½ oz. (50-130 ml)	16" (406 mm)
CONSTRUCTION: 26-GAUGE STAINLESS STEEL				
C3000PSS	SS	1¾"-2½" (44-64 mm)	1¾"-4½ oz. (50-130 ml)	16" (406 mm)

* Specify desired color after item number. Example: C3260TBR



LID & STRAW

- Save money by reducing waste with San Jamar's lid dispensers
- The EZ Fit® lid dispenser dispenses cold beverage lids one-at-a-time



L2204

Lid Towers

- High capacity lid and straw organization
- Countertop design allows you to move organizer and accommodate changing needs

Item	Includes	Dimensions H x W x D
L2202	(2) lid compartments (1) straw compartment	18¾" x 5½" x 13" (476 x 140 x 330 mm)
L2203	(3) lid compartments (1) straw compartment	24½" x 5½" x 13" (622 x 140 x 330 mm)
L2204	(4) lid compartments (1) straw compartment	30" x 5½" x 13" (762 x 140 x 330 mm)

Construction: Black polystyrene



Wall-Mount Lid Dispensers

- Designed to keep your lids clean and organized
- Available in single and double lid designs
- Front-loading provides easy and smooth access to lids
- Brackets allow for either wall or dispenser stand mounting

Item	Capacity	Max Lid Rim Diameter	Approx. Cup Size	Tube Length
L3200	1 sleeve	3½" (89 mm)	6-10 oz. (180-300 ml)	23½" (597 mm)
L3400	1 sleeve	4" (101 mm)	12-24 oz. (350-710 ml)	23½" (597 mm)
L3500	1 sleeve	5" (127 mm)	32-46 oz. (950-1360 ml)	23½" (597 mm)
L3402 (double lid)	1 sleeve	4" (101 mm)	6-24 oz. (180-710 ml)	23½" (597 mm)
L3502 (double lid)	1 sleeve	5" (127 mm)	24-46 oz. (710-1360 ml)	23½" (597 mm)

Construction: 22-gauge stainless steel



L3400

L3402

Adjustable Lid Organizers

- Can be placed on a countertop or wall mounted
- Adjustable compartments adapt to the lid size being dispensed
- Comes with straw caddy (L1035) that can attach to either side

Item	Capacity	Dimensions H x W x D
L1014	3 stacks	6½" x 17½" x 5½" (165 x 435 x 130 mm)
L1022	5 stacks	6½" x 25¼" x 5½" (165 x 641 x 130 mm)

Construction: (Lid organizers) 22-gauge stainless steel; (Stirrer & straw caddy) high-impact plastic



L1022

Lid Organizers

- Keep lids organized and easily accessible to customers
- Countertop design allows you to move organizer to accommodate changing needs

Item	Dimensions H x W x D
L2100	11" x 12½" x 16½" (279 x 318 x 419 mm)
L2150	10¾" x 8½" x 16½" (273 x 216 x 419 mm)

Construction: 22-gauge 304-stainless with impact resistant plastic tray



L2100

Condiment & Straw Organizer

Item	Dimensions H x W x D
L2900	9½" x 8⅞" x 25⅜" (241 x 208 x 637 mm)

Construction: Black polystyrene



Large Trash Chute

Item	Diameter	Tube Length
L360C	6⅝" (168 mm)	5¼" (133 mm)

Construction: 22-gauge stainless steel



EZ-Fit® In-Counter Lid Dispensers

- Provides simple, sanitary dispensing of most flat cold-beverage lids
- One-handed operation is easy to use
- Front loading; requires no adjustment

Item	Lid Rim Diameter	Approx. Cup Size	Counter Hole Diameter	Tube Length
L2200C	2¾" - 3¼" (70-95 mm)	8-24 oz. (236-710 ml)	4⅞" (124 mm)	23¾" (603 mm)
L2400C	3¾" - 4½" (95-114 mm)	24-46 oz. (710-1360 ml)	5¾" (146 mm)	23¾" (603 mm)

Construction: Impact resistant plastic



L2400C

EZ-Fit® Lid Dispenser Cabinets*

- Durable and attractive countertop lid dispensers
- Available in 1, 2 and 3-compartment cabinets; two lid dispenser sizes to accommodate most sizes of lids
- Simple design has few parts and requires no adjustment

Item	Includes	Dimensions H x W x D
L2910BK	(1) L2200C; black trim ring	7¾" x 7¾" x 25⅞" (197 x 197 x 645 mm)
L2920BK	(1) L2400C; black trim ring	7¾" x 7¾" x 23¾" (197 x 197 x 654 mm)
L2912BK	(1) L2200C; (1) L2400C, black trim rings	15½" x 7¾" x 25⅞" (384 x 197 x 645 mm)
L2913BK	(2) L2200C; (1) L2400C, black trim rings	22⅞" x 7¾" x 25⅞" (568 x 197 x 645 mm)
L2923BK	(1) L2200C; (2) L2400C, black trim rings	22⅞" x 7¾" x 25⅞" (568 x 197 x 645 mm)

Construction: Black polystyrene

*EZ-Fit® Lid Dispensers are intended for use with flat, cold beverage lids only. May not be compatible with all lid types. To confirm lid compatibility, please provide a full sleeve of lids prior to ordering.



L2912BK

L2913BK

Straw Dispenser

- In-counter dispenser organizes straws and stirrers utilizing simple mounting ring to lock secure holder

Item	Straw Rim Diameter	Counter Hole Diameter	Tube Length
L320C	5⅝" (136 mm)	4⅞" (106 mm)	6" (152 mm)

Construction: 22-gauge stainless steel

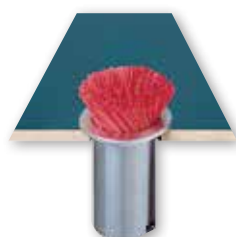

FOOD SAFETY TOOLS

Cross-contamination is a danger to any foodservice operation.

San Jamar's innovative food safety tools promote safe food handling, sanitation, and more importantly, keep operations thriving and protected from food safety risks.



SAFE ICE HANDLING

SAFE FOOD
PREPARATION

SANITATION TOOLS

CUTTING BOARDS



SAFE ICE HANDLING

TOTES

SCOOPS & HOLDERS

TOTES

- The original dedicated Saf-T-Ice® Tote is designed to make ice transport easier and safer than traditional “buckets”
- Unique patented features and accessories



SI6100

SI6000

Original & Shorty™ Saf-T-Ice® Tote

- Dedicated container for safe ice transport
- HACCP Hanger™ reduces back strain and injuries
- Tri-grip™ design for easier, more controlled handling

Item	Description	Capacity
SI6000	Original Saf-T-Ice® Tote	6 gallons (22.7 L)
SI6100	Shorty™ Saf-T-Ice® Tote	5 gallons (18.9 L)

NSF

“ This is a great ice bucket and it is so convenient that it can hang off the side of the ice machine for easy filling. A big plus is that it has the hardware necessary to hang the bucket upside down. My health inspector loves it!

~ Ryan D.

SCOOPS & HOLDERS

- Saf-T-Scoop® and Guardian™ Systems provide a safe and sanitary way to serve ice
- Available in 4-6 oz. (118-177 ml), 6-10 oz. (177-296 ml), 12-16 oz. (355-473 ml), 20-24 oz. (591-710 ml) or 64-86 oz. (1.9-2.5 L) for the bar, beverage station or ice machine
- Dual Germ-Guards™ protect ice from hand contamination
- Guardian™ Scoop holder encloses and protects scoop from splash-up contamination
- Durable & dishwasher safe



Saf-T-Ice® Value Pack

- The complete solution for preventing ice contamination at the ice machine
- Saf-T-Scoop® protects ice from hand contact and directs ice right into Saf-T-Ice® Tote, minimizing dangerous ice spills

Item	Description
SI8500	SI6000 Tote & 64-86 oz. (1.9-2.5 L) Saf-T-Scoop® and Guardian™ System (1 each)



Saf-T-Ice® Lid

- Fits both Original & Shorty™ Totes
- For sanitary & secure transport of ice

Item	Description
SI6500	For sanitary & secure transport of ice

Fits both SI6000 and SI6100



Saf-T-Ice® Cart **NEW**

- Cart transport system for use with (2) Saf-T-Ice® SI6000 or (2) SI6100
- Avoid costly work injuries; doubles productivity
- Folds for easy storage

Item	Description
SICART60	Cart transportation system for use with (2) SI6000 Saf-T-Ice® Totes (Totes sold separately)
SICART61	Cart transportation system for use with (2) SI6100 Saf-T-Ice® Totes (Totes sold separately)



Banquet/Beverage Saf-T-Scoop®

- Germ-Guards™ protect ice from contact with hands
- Drain holes prevent watering down of beverages
- Built in hook prevents cross contamination; stores neatly on side of bin

Item	Description
SI4550	Saf-T-Scoop® 4-6 oz. (118-177 ml) (scoop only)



Saf-T-Scoop® & Guardian™ System for Bar & Beverage Stations

- Germ-Guards™ protect ice from contact with hands
- Guardian™ provides safe, dedicated scoop storage
- Flexible mounting options

Item	Description
INCLUDED MOUNTING TOOLS: (1) MOUNTING BRACKET, (2) WIRE HANGING BRACKETS AND (2) SUCTION CUPS	
SI5000	Scoop Guardian™ System 6-10 oz. (177-295 ml) (1) Saf-T-Scoop®, (1) Guardian holder with removable drainage cap, (1) set mounting tools
SI5500	Saf-T-Scoop® 6-10 oz. (177-295 ml) (scoop only)
SI7000	Scoop Guardian™ System 12-16 oz. (355-473 ml) (1) Saf-T-Scoop®, (1) Guardian holder with removable drainage cap, (1) set mounting tools
SI7500	Saf-T-Scoop® 12-16 oz. (355-473 ml) (scoop only)
SI7700	Scoop Guardian™ System 20-24 oz. (591-710 ml) (1) Saf-T-Scoop®, (1) Guardian holder with removable drainage cap, (1) set mounting tools
SI7750	Saf-T-Scoop® 20-24 oz. (591-710 ml) (scoop only)



SI5000

Saf-T-Scoop® & Guardian™ System for Ice Machines

- Germ-Guards™ protect ice from contact with hands
- Guardian™ provides safe, dedicated scoop storage
- Flexible mounting options

Item	Description
INCLUDED MOUNTING TOOLS: (1) MOUNTING BRACKET, (2) WIRE HANGING BRACKETS AND (2) SUCTION CUPS	
SI9000	Scoop Guardian™ System 64-86 oz. (1.9-2.5 L) (1) Saf-T-Scoop®, (1) Guardian holder with removable drainage cap, (1) set mounting tools
SI9500	Saf-T-Scoop® 64-86 oz. (1.9-2.5 L) (scoop only)



SI9000

Saf-T-Ice® Scoop Caddy

- Dedicated, sanitary ice scoop storage
- Works with ice scoops up to 86 ounces
- Durable construction; dishwasher safe
- Flexible mounting options

Item	Color	Dimensions H x W x D
SI2000	Blue	11 ³ / ₁₀ " x 9 ¹ / ₈ " x 8" (287 x 231 x 204 mm)
SI2000BK	Black	11 ³ / ₁₀ " x 9 ¹ / ₈ " x 8" (287 x 231 x 204 mm)



SI2000BK

SI2000

SAFE FOOD PREPARATION

COLD PADDLES

COLD SERVE

SAFE PREP

COLD PADDLES

- Harmful bacteria grows most rapidly in food at temperatures between 135°F (57°C) and 41°F (5°C)
- Rapi-Kool® cold paddles chill soups and stews quickly and safely from the “inside-out” with special cooling “fins” that provide maximum surface area for faster chilling



RCU128V2



RCU64V2

Rapi-Kool® Plus Cold Paddles

- Wide opening allows for on-demand use by filling with ice and water
- Patented Fill-Rite™ design eliminates over-filling when pre-freezing
- Integrated hanging hook for sanitary and secure storage

Item	Description
RCU64V2	64 oz. (1.9 L)
RCU64V2RD	Retail Package 64 oz. (1.9 L) Unit fully assembled, in clear bag with hang tag
RCU128V2	128 oz. (3.8 L)
RCU128V2RD	Retail Package 128 oz. (3.8 L) Unit fully assembled, in clear bag with hang tag



“ The Rapi-Kool Plus 128 oz. cold paddle has been a great addition to our kitchen. It cools quickly and is easy to clean.

~ Michael B.





RCU256

RCU64

RCU128

Rapi-Kool® Cold Paddles

- Chills food from the "inside-out" – for fast, even cooling
- Unique "fin" design increases surface area to cool foods quickly
- Constructed of durable food-safe plastic; dishwasher safe

Item	Capacity
RCU64	64 oz. (1.9 L)
RCU128	128 oz. (3.8 L)
RCU256	256 oz. (7.6 L)



RCU1282

Rapi-Kool® Premium 2-Pack

- Handy 2-Pack ensures a back-up cold paddle is available for use
- Includes (2) extra caps and (1) Rapi-Kool® instructional Smart Chart

Item	Capacity
RCU642	64 oz. (1.9 L)
RCU1282	128 oz. (3.8 L)



RCUBRKT



RCUCAPPAK



RCUWLCT

Rapi-Kool® Accessories

- Wall chart provides step-by-step English and Spanish instructions
- Replacement caps are available to fit any size of Rapi-Kool® cold paddle
- Hanging brackets free up valuable freezer shelf space, holding Rapi-Kool® securely

Item	Capacity
RCUCAPPAK	Replacement Caps (4pk)
RCUWLCT	Wall Chart
RCUBRKT	Hanging Brackets (2pk)

Chill-It® Food Pans

- Portable cold-holding food pans with freezable non-toxic gel lining
- Freeze ahead for up to 8 hours of use
- Optional lids allow for stackable storage

Item	Colors	Capacity
CI7001*	WH, BK	¼ Pan: 52 oz. (1.5 L)
CI7002*	WH, BK	⅓ Pan Divided: 135 oz. (3.9 L)
CI7003*	WH, BK	⅓ Pan: 135 oz. (3.9 L)
CI7004*	WH, BK	½ Pan: 252 oz. (7.3 L)



CI7001

CI7002

CI7004

COLD SERVE

- Pre-freeze Chill-It® containers to maintain proper cold-holding temperatures without electricity
- Available in standard food pan sizes and handy crocks and pitchers

Chill-It® Food Pan Lids

Item	Fits	Lid Type
CI7111L	¼ Pan: 52 oz. (1.5 L)	Standard
CI7113L	⅓ Pan Divided: 135 oz. (3.9 L)	Standard
CI7114L	½ Pan: 252 oz. (7.3 L)	Standard
CI7111NL	¼ Pan: 52 oz. (1.5 L)	Notched

Bagged with header card



CI7113L



Chill-It® Crocks & Lids

- Versatile crocks can be used with optional lids and pumps
- Perfect for sauces and condiments that require chilling

Item	Colors	Description
CI7015*	WH, BK	2 qt. Crock
CI7016H	Clear	Clear Lid
CI7016NL	Clear	Notched Lid
CI7016P	Clear	Pump Lid



CI7016H



Chill-It® Pitcher

- Keeps beverages and other liquids icy cold
- Protects batters, sauces & other liquids from time-temperature abuse
- Freezes in just 3 hours

Item	Capacity
CI7025	60 fl. oz. (1.8 L)



* Specify desired color after item number. Example: CI7001 WH



White



Black

SAFE PREP

- Tools designed to create a safe food prep environment
- Minimize cross-contamination, manage food allergies and protect your customers and staff

T-Stick®

- Single use thermometer
- Ensure that your food is perfectly cooked
- Reduces cross-contamination risk



TST9343

Item	Description
TST9341	Green 140°F (60°C) Disposable, sanitary thermometer sticks
TST9343	Black 160°F (71°C) Disposable, sanitary thermometer sticks
TST9345	Brown 170°F (77°C) Disposable, sanitary thermometer sticks

T-Stick® is a registered trademark of William-Allen, Inc.

Saf-T-Wrap® Station

- Saves money by reducing labeling time and minimizing food waste by aiding in FIFO food rotation
- Dispenses dating labels in multiple sizes and configurations
- Available with safety blade for film, foil and paper—or slide cutter for one-handed film dispensing



SW1218SC

Item	Description	Capacity	Core Diameter
SW1218	Saf-T-Wrap® Station with Safety Blade (for film, foil or paper)	Accepts date label rolls from 0.75"-3" (1.9-7.6 cm) wide; 3.25" (8.25 cm) diameter. (1.9 L) Dispense Film/Foil/Paper rolls from 12"-18" (30.48-42.75 cm), 5.1" (12.95 cm) total diameter	12" (305 mm) min.
SW1218SC	Saf-T-Wrap® Station with Slide Cutter (for film)	Accepts date label rolls from 0.75"-3" (1.9-7.6 cm) wide; 3.25" (8.25 cm) diameter. (1.9 L) Dispense Film rolls from 12"-18" (30.48-42.75 cm), 5.1" (12.95 cm) total diameter	12" (305 mm) min.

Saf-T-Wrap® 12 & 18 **NEW**

- Accommodates film or foil rolls and saves time while minimizing waste
- Includes both safety blade for film, foil and paper - or slide cutting for one-handed film dispensing
- Film and foil rolls are fully enclosed and protected preventing cross-contamination from unsanitary cardboard cutter boxes
- Economical by utilizing entire roll and keeping your film/foil in a durable, protected dispenser; resulting in substantial cost savings



SW12

Item	Description	Capacity
SW12	Saf-T-Wrap® with Slide Cutter and optional Safety Blade (for film or foil)	Dispense Film/Foil rolls from 12" (305 mm)
SW18	Saf-T-Wrap® with Slide Cutter and optional Safety Blade (for film or foil)	Dispense Film/Foil rolls from 15"-18" (381 mm - 457 mm)
SWX100	Saf-T-Wrap® Stackers (2) Brackets (8) Wing Nuts	Dispense Film/Foil rolls from 12"-18" (305 mm - 457 mm)

Saf-T-Knife® Station*

- Sanitary, safe and secure storage for kitchen knives
- Protects knives from contamination and accidents
- Easy to assemble and clean

Item	Dimensions H x W x D
STK1008	15" x 15" x 4¼" (381 x 381 x 108 mm)



*Knives not included

Saf-T-Knife® Station Jr.* **NEW**

- Color-coded lids designed to keep track of which knife is used for what purpose
- Sanitary, safe and secure storage for kitchen knives
- Perfect size for prep lines and smaller kitchens
- Easy to assemble and clean

Item	Description	Dimensions H x W x D
STK1006	Saf-T-Knife® Station Jr.	14½" x 8¾" x 4" (368 x 211 x 102 mm)
STK1006RDL	Saf-T-Knife® Station Jr. - Red (Lid Only)	17½" x 8" x 4" (48 x 203 x 102 mm)
STK1006GRL	Saf-T-Knife® Station Jr. - Green (Lid Only)	17½" x 8" x 4" (48 x 203 x 102 mm)
STK1006YLL	Saf-T-Knife® Station Jr. - Yellow (Lid Only)	17½" x 8" x 4" (48 x 203 x 102 mm)



*Knives not included



Allergen Saf-T-Zone™ System

- Purple color alerts staff to follow special food allergy procedures
- Includes commercial-grade cutting board, tongs, turner and Chef's knife
- Durable purple case is easy to find in the kitchen and securely protects tools and board

Additional Allergen Saf-T-Zone™ cutting boards and sizes are available on pg. 73.

Item	Includes
ASZ121812SYS	(1) Saf-T-Grip® purple cutting board (CBG121812PR) 12" x 18" x ½" (305 x 457 x 13 mm) (1) Stainless steel chef knife with purple handle 10" (254 mm) (1) Stainless steel tongs with purple handle 12" (305 mm) (1) Stainless steel turner with purple handle 13" (330 mm) (Thermometer not included)
ASZTHERMW	Professional digital thermometer with protective sheath, dishwasher safe



ASZ121812SYS



Thermometer sold separately

ASZTHERMW



Allergen Saf-T-Zone™ Cutting Board CBG121812PR
10" Chef Knife ASZKNIFE
12" Tongs ASZTONGS
13" Turner ASZTURNER

SANITATION TOOLS

PAILS

TOOLS



PAILS

- Kleen-Pail®, the original dedicated non-food container for safe foodservice cleaning and sanitation
- Available in sizes for front or back-of-the house



Kleen-Pail®

- Color-coded pails for use with detergent and sanitizer
- Durable, robust handle design
- New embossed feature designed to meet health code
- Trilingual design aids in training

Item	Color	Description
KP97*	RD, GN	3 quart (2.84 L)
KP196*	RD, GN	6 quart (5.68 L)
KP256*	RD, GN	8 quart (7.57 L)
KP320*	RD, GN	10 quart (9.46 L)

PAIL USAGE GUIDE

■ = Sanitizer ■ = Detergent (Cleaner)

“ This product is just what you need to be health department ready! When they see the approved red container it makes them happy. I received a 100% on my inspection yesterday. ”

~ Crystal D.

* Specify desired color after item number. Example: KP97GN



TOOLS

- Make proper sanitation easier, more efficient and meet health codes
- Unique, patented products combine several processes for convenience and safety



KPS196



KP500



KPDET

KPSAN

Kleen-Pail® Stands*

- Allows you to move Sanitizer and Detergent Pails off of the floor or work surface
- Provides a sanitary storage holder for KP196* and KP97*

Item	Description
KPS196	Kleen-Pail stand holds KP196
KPS97	Kleen-Pail stand holds KP97
KPS196WM	Kleen-Pail wall mount stand holds KP196
KPS97WM	Kleen-Pail wall mount stand holds KP97

*Kleen-Pail sold separately.

Caddy™ System

- Integrated spray bottle creates portable cleaning and sanitizing system
- Saves time and reduces labor
- Trilingual design aids in training

Item	Description
KP500	(1) green caddy (1) spray bottle
KP550GN	(1) green caddy

Kleen-Pail® Sanitizer & Detergent

- Pre-measured, water soluble packets to ensure proper dilution
- Sanitizer for food-contact surfaces in restaurants and kitchens
- All-purpose detergent for cleaning any surface

Item	Description
KPSAN	90 water soluble sanitizer packets for KP196RD
KPDET	90 water soluble detergent packets for KP196GN

HACCP Food Safety Kit

- Train staff or students in basic food safety principles with products designed to aid with HACCP procedures

Item	Description
HACCPKIT	Saf-T-Ice® Shorty™ Tote (Item #SI6100)
	Saf-T-Ice® Lid (Item# SI6500)
	Saf-T-Scoop® & Guardian System™ (Item #SI5000)
	Rapi-Kool® Plus Cold Paddle (Item #RCU64V2)
	Rapi-Kool® Smart Chart (Item #RCUWLCT)
	Saf-T-Grip® Cutting Board (Item #CBG121812GN)
	Cutting Board Smart Chart (Item #CBCWLCTST)
	Kleen-Pail® 3-QT (Item #KP97GN)
	Kleen-Pail® 6-QT (Item #KP196RD)
	Kleen-Plug™ (Item # KLP200)
	Saf-T-Grip® Board-Mate (Item# CBM1318)
	Saf-T-Grip® Allergen Saf-T-Zone™ 9" x 12" Cutting Board (Item #CBG912PR)
	Saf-Check® Quat Test System with thermometer (Item #SFC1200QT)
	Mani-Kare® Bandages (Item #MK0901)
	Versa Mat® Bar Matting (Item #VM5280BK)
T-Stick® Samples 140° F, 160° F and 170° F (Item #TST9341, #TST9343, #TST9345)	
Klever Kutter™ 3-Pack (Item #KK403)	

Saf-Check®

- Combines thermometer and sanitizer test strips with easy-to-read Smart Scale™ guide
- Thumb wheel easily dispenses test strips
- Holds replaceable 15 ft. (4.57 m) roll of Chlorine or Quaternary test strips

Item	Description
MEASURES	
SFC1200CL	Chlorine measure with thermometer
SFC1200QT	Quaternary measure with thermometer
SFC1250CL	Chlorine measure without thermometer
SFC1250QT	Quaternary measure without thermometer
REPLACEMENT TEST STRIP ROLLS	
SFCROLLCL	Chlorine replacement rolls (2) 15 ft. rolls
SFCROLLQT	Quaternary replacement rolls (2) 15 ft. rolls



SFC1200QT

Kleen-Cup®

- Effectively cleans and sanitizes mixer spindles, replaceable brushes
- Prevents flavor transfer and cross-contamination

Item	Description	Dimensions H x D
KLC28C	(1) Kleen-Cup spindle sanitizer	7¾" x 4" (197 x 102 mm)



Fridge-Kare™

- Removes moisture from the air and reduces odor in walk-in and reach-in coolers
- Decreases bacteria and mold growth

Item	Description
FK1000	One Fridge-Kare® treats 250 cubic feet for up to 6 months



ServSafe® Coursebook 6th Edition

- Prepares foodservice professionals for extended one-day or two-day certification programs

Item	Description
SERVSABOOK	Course book for ServSafe® certification



ServSafe® is a registered trademark of the National Restaurant Association Education Foundation

Smart Charts

- Instructional charts for color-coding cutting boards, using Rapi-Kool® chill paddles and proper handwashing practices

Item	Includes	Dimensions H x W
RCUWLCT	Rapi-Kool® Smart Chart	17" x 11" (432 x 279 mm)
CBCWLCTST	Color-Coded Cutting Board Smart Chart	17" x 11" (432 x 279 mm)
QSWLCT	Cut-N-Carry® 4 Board Color-Coded Smart Chart	11½" x 14½" (292 x 368 mm)
HWWLCT	Hand Washing Station Smart Chart	9" x 6" (229 x 152 mm)



CUTTING BOARDS

GRIP BOARDS | STANDARD BOARDS | SPECIALTY & CUSTOM BOARDS | ACCESSORIES

GRIP BOARDS

- Saf-T-Grip® integrated grip corners provide a safe and secure prep surface
- Durable co-polymer and molded-in grips designed to stand up to the toughest commercial kitchen environments
- Integrated ruler makes portioning easy, eliminating guess-work and saving money
- Patented Food Safety Hook allows for sanitary transport and storage



Saf-T-Grip® Cutting Boards

- Integrated anti-slip grips securely hold board in place
- Patented Food Safety Hook for sanitary transport and storage
- Durable co-polymer material will not warp

Item	Color	Dimensions HxWxD
CBG6938*	BK, GN, RD, WH, YL	6" x 9" x 3/8" (152 x 229 x 9.5 mm)
CBG912*	BL, BR, GN, RD, WH, YL	9" x 12" x 3/8" (229 x 305 x 9.5 mm)
CBG121812*	BL, BR, GN, RD, WH, YL	12" x 18" x 1/2" (305 x 457 x 13 mm)
CBG152012*	BL, BR, GN, RD, WH, YL	15" x 20" x 1/2" (381 x 508 x 13 mm)
CBG182412*	BL, BR, GN, RD, WH, YL	18" x 24" x 1/2" (457 x 610 x 13 mm)



“ Saf-T-Grip® boards are very durable and perfect for use in the kitchen or bar. The non-slip grips make the cutting boards safe and easy to use. ”

~ Eric K.

* Specify desired color after item number. Example: CBG6938BK





Saf-T-Grip® White Cutting Boards

- Reduce cross-contamination with color-coded cutting boards
- All the great features and benefits of our Saf-T-Grip® family, with the tradition of a white cutting board
- Durable co-polymer material will not warp

Item	Color	Dimensions H x W x D
CBGW912*	BL, GN, YL, RD	9" x 12" x 3/8" (229 x 305 x 9.5 mm)
CBGW152012*	BL, GN, YL, RD	15" x 20" x 1/2" (381 x 508 x 13 mm)



Saf-T-Grip® White 4-Board System

- Reduce cross-contamination with color-coded cutting boards
- All the great features and benefits of our Saf-T-Grip® family, with the tradition of a white cutting board
- Durable co-polymer material will not warp



Item	Color	Dimensions H x W x D
WHITE BOARDS WITH (EACH) OF THE COLORED GRIPS: GREEN, RED, YELLOW AND WHITE		
CBGW912QS	WH, GN, YL, RD	9" x 12" x 3/8" (229 x 305 x 9.5 mm)
CBGW152012QS	WH, GN, YL, RD	15" x 20" x 1/2" (381 x 508 x 13 mm)



Saf-T-Grip® 6-Board System

- Reduce cross-contamination with color-coded cutting boards
- Includes customizable color-coding Smart Chart™ with stickers
- Durable co-polymer material will not warp



Item	Dimensions H x W x D
CONTAINS (EACH) BLUE, BROWN, GREEN, RED, WHITE, YELLOW CUTTING BOARDS & FREE COLOR-CODED SMART CHART.	
CBG1218KC	12" x 18" x 1/2" (305 x 457 x 13 mm)
CBG1520KC	15" x 20" x 1/2" (381 x 508 x 13 mm)
CBG1824KC	18" x 24" x 1/2" (457 x 610 x 13 mm)



Saf-T-Grip® Bar/Snack Boards

- Durable co-polymer construction will not warp
- Material won't dull knives and resists unsanitary cut-grooving
- Smaller size is ideal for tight spaces



Item	Colors	Dimensions H x W x D
CBG6938*	BK, GN, RD, WH, YL	6" x 9" x 3/8" (152 x 229 x 9.5 mm)



Allergen Saf-T-Zone™ Cutting Boards

- Helps protect guests with food allergies
- Purple color alerts staff to follow special procedures
- Durable co-polymer material will not warp



Item	Dimensions H x W x D
CBG6938PR	6" x 9" x 3/8" (152 x 229 x 9.5 mm)
CBG912PR	9" x 12" x 3/8" (229 x 305 x 9.5 mm)
CBG121812PR	12" x 18" x 1/2" (305 x 457 x 13 mm)



STANDARD BOARDS

- Premium, cutting boards with Cut-N-Carry® patented Food Safety Hook
- Color options allow for color-coding to minimize cross-contamination during prep

Cut-N-Carry® Color Cutting Boards

- Patented Food Safety Hook design for sanitary transport and storage
- Durable co-polymer construction provides superior heat, chemical and warp resistance
- Material won't dull knives and resists unsanitary cut-grooving



Item	Color	Dimensions H x W x D
CB101212*	GN, YL	10" x 12" x 1/2" (254 x 305 x 13 mm)
CB121812*	BL, BR, GN, RD, YL	12" x 18" x 1/2" (305 x 457 x 13 mm)
CB152012*	BL, BR, GN, RD, YL	15" x 20" x 1/2" (381 x 508 x 13 mm)
CB182412*	BL, BR, GN, RD, YL	18" x 24" x 1/2" (457 x 610 x 13 mm)
CB121834*	BL, GN, RD, YL	12" x 18" x 3/4" (305 x 457 x 19 mm)
CB182434*	BL, BR, GN, RD, YL	18" x 24" x 3/4" (457 x 610 x 19 mm)



Cut-N-Carry® 4 & 6-Board Systems

- Reduce cross-contamination with color-coded cutting boards
- Includes customizable color-coding Smart Chart™
- Durable co-polymer construction provides superior heat, chemical and warp resistance



Item	Description	Dimensions H x W x D
CB1218QS	4-Board System: (1ea) green, red, white, yellow cutting boards and a Color-Coded Smart Chart	12" x 18" x 1/2" (305 x 457 x 13 mm)
CB1520QS		15" x 20" x 1/2" (381 x 508 x 13 mm)
CB1824QS		18" x 24" x 1/2" (457 x 610 x 13 mm)
CB1218KC	6-Board System: (1ea) blue, brown, green, red, white, yellow cutting boards and a Color-Coded Smart Chart	12" x 18" x 1/2" (305 x 457 x 13 mm)
CB1520KC		15" x 20" x 1/2" (381 x 508 x 13 mm)
CB1824KC		18" x 24" x 1/2" (457 x 610 x 13 mm)

4-Board Cut-N-Carry® System



* Specify desired color after item number. Example: CBGW912BL





Cut-N-Carry® White Cutting Boards

- Patented Food Safety Hook design for sanitary transport and storage
- Material won't dull knives and resists unsanitary cut-grooving
- Durable co-polymer construction will not warp

Item	Dimensions H x W x D
CB101212WH	10" x 12" x ½" (254 x 305 x 13 mm)
CB121812WH	12" x 18" x ½" (305 x 457 x 13 mm)
CB152012WH	15" x 20" x ½" (381 x 508 x 13 mm)
CB182412WH	18" x 24" x ½" (457 x 610 x 13 mm)
CB183012WH	18" x 30" x ½" (457 x 762 x 13 mm)
CB242412WH	24" x 24" x ½" (610 x 610 x 13 mm)
CB121834WH	12" x 18" x ¾" (305 x 457 x 19 mm)
CB152034WH	15" x 20" x ¾" (381 x 508 x 19 mm)
CB182434WH	18" x 24" x ¾" (457 x 610 x 19 mm)
CB183034WH	18" x 30" x ¾" (457 x 762 x 19 mm)
CB242434WH	24" x 24" x ¾" (610 x 610 x 19 mm)



White Cutting Boards

- Material won't dull knives and resists unsanitary cut-grooving
- Durable co-polymer construction will not warp

Item	Dimensions H x W x D
CB12181WH	12" x 18" x 1" (304 x 457 x 25 mm)
CB15201WH	15" x 20" x 1" (381 x 508 x 25 mm)
CB18241WH	18" x 24" x 1" (457 x 609 x 25 mm)



White Grooved Cutting Boards

- Groove design reduces cross-contamination by stopping food juices from spilling onto countertops and food prep areas
- Reduces mess and clean-up
- Durable co-polymer construction will not warp

Item	Dimensions H x W x D
CB121812GVWH	12" x 18" x ½" (305 x 457 x 13 mm)
CB152012GVWH	15" x 20" x ½" (381 x 508 x 13 mm)
CB182412GVWH	18" x 24" x ½" (457 x 610 x 13 mm)
CB182434GVWH	18" x 24" x ¾" (457 x 610 x 19 mm)



White Bar Board

- Material won't dull knives and resists unsanitary cut-grooving
- Smaller size is ideal for tight spaces
- Durable co-polymer construction will not warp

Item	Dimensions H x W x D
CB6912WH	6" x 9" x ½" (152 x 229 x 13 mm)

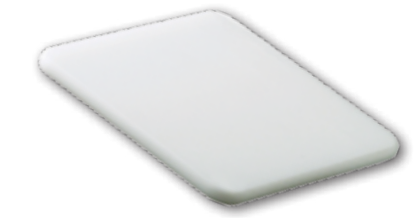

SPECIALTY & CUSTOM BOARDS

- Available in co-polymer and our patented Tuff-Cut® high-heat materials
- Choose a standard size or customize to accommodate any application

Tuff-Cut® Cutting Boards

- Designed for high-heat applications
- Rated to withstand temperatures up to 350°F (177°C) without warping or scorching
- Ideal for use as pizza peels and meat carving



Item	Description	Dimensions H x W x D
TC121812	Regular cutting board	12" x 18" x ½" (305 x 457 x 13 mm)
TC152012	Regular cutting board	15" x 20" x ½" (381 x 508 x 13 mm)
TC182412	Regular cutting board	18" x 24" x ½" (457 x 610 x 13 mm)
TC121812GV	Grooved cutting board	12" x 18" x ½" (305 x 457 x 13 mm)
TC152012GV	Grooved cutting board	15" x 20" x ½" (381 x 508 x 13 mm)
TC182412GV	Grooved cutting board	18" x 24" x ½" (457 x 610 x 13 mm)



Tuff-Cut® Bread Boards

- Designed for high-heat applications and serrated knife use
- Rated to withstand temperatures up to 350°F (177°C) without warping or scorching
- Different sizes and shapes for bread cutting and serving



Item	Description	Dimensions H x W x D
TC7501	Bread board with 5" (127 mm) handle	7" x 9" x ¼" (178 x 229 x 6 mm)
TC7502	Bread board with 6" (152 mm) handle	7" x 9" x ½" (178 x 229 x 13 mm)
TC7503	Bread board with 4" (102 mm) handle & butter well	8½" x 6½" x ¾" (216 x 165 x 19 mm)



Tuff-Cut® Custom Cutting Boards

- Same high-quality Tuff-Cut® material in custom sizes and shapes
- Ships within 48 hours

Item	Thickness
TC4812014	¼" (6 mm)
TC4812038	⅜" (9.5 mm)
TC4812012	½" (13 mm)
TC4812034	¾" (19 mm)
TC481201	1" (25 mm)

All cuts are straight edge unless otherwise requested (additional cost).



Custom-Cut Cutting Boards

- High-quality material is durable, heat-resistant and will not dull knives
- Ships in 48 hours

Item	Color	Thickness
CBL6012012	GN, RD, YL, BL, BR, WH	½" (13 mm)
CBL6012034	White only	¾" (19 mm)
CBL601201	White only	1" (25 mm)

Special cuts, holes and patterns are available at an additional cost.

All cuts are straight edge unless otherwise requested (additional cost).

Complex cuts and large quantities (over 15) may take longer than 48 hours.



How to Order a Custom Cutting Board

Step 1: Pick your thickness from choices above

Step 2: Pick your size - any size

Step 3: Call in your order to Customer Care **1.800.248.9826** or email us at sjorders@sanjamar.com

Visit our online Custom Cutting Board Calculator: <http://customcutbrd.sanjamar.com>

Please Note: Special cuts, holes and patterns are available at an additional cost. All cuts are straight edge unless otherwise requested (additional cost).

Complex cuts and large quantities (over 15) may take longer than 48 hours. ¾" boards and 1" boards are only available in white.



ACCESSORIES

- Convenient cutting board storage, Board-Mate® non-slip board mats and color-coding wall charts

Saf-T-Grip® Board-Mate®

- Replaces unsanitary "wet towel" to keep non-grip boards from shifting and sliding
- Reduces knife accidents and injuries during prep
- Also keeps countertop appliances from slipping

Item	Dimensions H x W
CBM1016	10" x 16" (254 x 406 mm)
CBM1318	13" x 18" (330 x 457 mm)
CBM1622	16" x 22" (406 x 559 mm)



Cutting Board Accessories

- Material won't dull knives & resists unsanitary cut-grooving

Item	Description
KLRST	Cutting board storage stand with non-slip feet
CNCRK	Shelf-mounting hanging rack
CBCWLCTST	Color-coded cutting board smart chart / 6-board with stickers
QSWLCT	Color-coded cutting board smart chart / 4-board



KLRST



CNCRK



QSWLCT



CBCWLCTST

BAR & FOOD MANAGEMENT

In the hectic world of foodservice – safety, efficiency and looking good to your patron, is paramount. From proper ice handling and food storage to clean-up, San Jamar is responsive to food operators, continuously creating new tools to make life a little easier in the kitchen, at the bar and at the dining table.



BAR
MANAGEMENT

FOOD
MANAGEMENT

KITCHEN
MANAGEMENT



GARNISH CENTERS

- Multiple options to organize & serve garnishes
- Enhances image and sanitation; chillable tray options available

THE DOME® & MINI DOME® PRODUCT DIMENSIONS

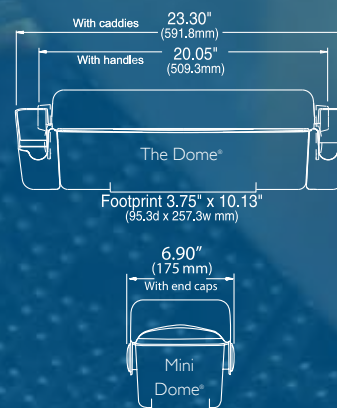

BD4005E

The Dome® Garnish Centers

- Patented, domed lid rotates back for easy access and increased capacity when closed
- Use standard size trays to keep food chilled or deep trays for extra capacity
- Integrated snap-on caddies store straws, stirrers & picks

Item	Description	Capacity
BD4005S	(1) 2 qt. (1.9 L) deep tray; (4) 1 pt. (0.47 L) standard trays; (2) snap-on caddies, handles	4 qt. (3.8 L)
BD4005E	(1) 2 qt. (1.9 L) deep tray; (4) 1 pt. (0.47 L) standard trays; (2) end caps; (1) snap-on caddy	4 qt. (3.8 L)
BD4023S	(2) 3 qt. (2.9 L) deep trays; (3) 1 pt. (0.47 L) standard trays; (2) snap-on caddies, handles	4.5 qt. (4.25 L)
BD4006S	(6) 1 pt. (0.47 L) standard trays; (2) snap-on caddies, handles	3 qt. (2.8 L)
INSERT TRAYS		
BD4003	(3) 2 qt. (1.9 L) quart deep trays; (2) handles	6 qt. (5.6 L)
BD4004	(4) 3 pt. (2.9 L) deep trays; (2) handles	6 qt. (5.6 L)
BD4014	(4) 1.5 pt. (0.71 L) standard trays; (2) handles	3 qt. (2.8 L)

Construction: High-impact plastic



“ The Dome bar is perfect! It holds six different garnishes and has room for straws. The top is great because it helps keep the garnishes fresh longer. Great investment for your bar!

~ Laura B.



BAR MANAGEMENT

GARNISH CENTERS

BAR TOOLS

SHELF MATTING



BD2001

Mini Dome® Garnish Centers

- Patented, domed lid design in a smaller size; notched lid option
- Connectors provide modularity between Mini Dome®, Dome® and snap-on caddies

Item	Description	Capacity
EACH MINI DOME® COMES WITH (2) END CAPS AND (1) CONNECTOR		
BD2001	(1) 2 qt. (1.9 L) deep tray	2 qt. (1.9 L)
BD2002	(1) 1 qt. (0.95 L) standard tray	1 qt. (0.95 L)
BD2003	(2) 1 pt. (0.47 L) standard trays	2 pt. (0.47 L)
BD2004NL	(2) 1.5 pt. (0.71 L) deep trays (notched domed lid)	3 pt. (1.4 L)
BD2002CAR	(1) 1 qt. (0.95 L) standard tray (with caddy)	1 qt. (0.95 L)
BD2004CAL	(2) 1.5 pt. (0.71 L) trays (with left hand caddy)	3 pt. (1.4 L)

Construction: High-impact plastic



Dome® Garnish Center not included

The Dome® Glass Rimming Station

- Comprehensive bar management system
- Promotes all-in-one station for serving beverages/cocktails
- Allows for storage of bar board and paring knife

Item	Description
BDRX400	Rimming Station to be used with The Dome® Garnish Centers Includes (3) 5" round trays, (1) 4" round tray and (1) sponge for 5" tray

Construction: High-impact plastic



BDS4266



BDS2203



BDS2483NL

Dome® Stacker

- Allows you to customize a configuration using Dome® and Mini Dome® to fit virtually any space
- Makes your operation more efficient, more organized and more professional

Item	Description	Capacity
BDSX100	Dome® Stacker Conversion Kit - converts your Dome® and Mini Dome® into a versatile, organized garnish center (Dome and Mini Dome not included)	N/A
BDS2203	Dome® Stacker - 1/1 Mini Dome: (4) 1 pt. trays & bonus (2) 2 qt. trays	4 qt. (3.8 L)
BDS2204NL	Dome® Stacker - 1/1 Mini Dome: (4) 1.5 pt. deep trays - notched lids & bonus (2) 2 qt. trays	4.5 qt. (4.25 L)
BDS2401NL	Dome® Stacker - 2/2 Mini Domes: (4) 2 qt. deep Trays	3 qt. (2.8 L)
BDS2483NL	Dome® Stacker - 2/2 Mini Domes: (4) 1.5 pt. deep trays, (4) 1 pt. standard trays, (2) notched lids & (2) standard lids	6 qt. (5.6 L)
BDS4206	Dome® Stacker - 1/1 Dome®: (12) 1 pt. standard trays	6 qt. (5.6 L)
BDS4266	Dome® Stacker - 1/1 Dome®: (3) 2 qt. deep trays, (6) 1 pt. standard trays (chillable)	3 qt. (2.8 L)

Construction: High-impact plastic



The Dome® & Mini Dome® Replacements

- Choose from a wide variety of tray configurations; chillable and non-chillable
- Snap-on caddies and connectors available for maximum flexibility

Item	Description
BD100S	(2) Snap-on caddies
BD101	1 pt. (0.47 L) standard tray - chillable
BD102	1.5 pt. (0.71 L) standard tray - chillable - for Dome® only
BD103	3 pt. (1.4 L) deep tray - for Dome® only
BD104	2 qt. (1.9 L) deep tray
BD105	1.5 pt. (0.71 L) deep tray
BD106	1 qt. (0.95 L) standard tray - chillable
BD110	Connector

Construction: High-impact plastic



BD101



BD104



BD105



BD106



B6186L

EZ-Chill™ Garnish Centers

- Portable and chillable stainless steel garnish centers
- Hinged, transparent lid protects garnishes and will not rust
- For use with EZ-Chill™ ice packs or ice

Item	Description	Dimensions H x W x D
B6183L	(3) 1 qt. (0.95 L) inserts with plex lid; (3) Ice liners; (3) EZ-Chill packs	5 7/8" x 18" x 5 3/8" (149 x 457 x 137 mm)
B6186L	(6) 1 pt. (0.47 L) inserts with plex lid; (6) Ice liners; (3) EZ-Chill packs	5 7/8" x 18" x 5 3/8" (149 x 457 x 137 mm)
B6766L	(3) 1 qt. (0.95 L) inserts; (12) 1 pt. (0.47 L) containers; (2) Bar caddies; (2) Ice liners; (6) EZ-Chill ice packs	12 3/4" x 20 7/8" x 12" (324 x 530 x 305 mm)

Construction: 22-gauge stainless steel with high-impact plastic



B4186L

Non-Chilled Garnish Trays

- Attractive stainless steel construction provides years of use
- Transparent lids protect garnishes; split lid option
- Interchangeable pint and quart inserts are easy-to-clean

Item	Description	Dimensions H x W x D
B4093L	(3) 1 pt. (0.47 L) inserts with plex lid	3 1/2" x 9 1/4" x 5 3/4" (89 x 232 x 146 mm)
B4124L	(4) 1 pt. (0.47 L) inserts with plex lid	3 1/2" x 12 1/8" x 5 3/4" (89 x 308 x 146 mm)
B4155L	(5) 1 pt. (0.47 L) inserts with plex lid	3 1/2" x 15" x 5 3/4" (89 x 381 x 146 mm)
B4186L	(6) 1 pt. (0.47 L) inserts with plex lid	3 1/2" x 18" x 5 3/4" (89 x 457 x 146 mm)
SPLIT-LID DESIGN		
B4246L	(2) 1 qt. (0.95 L) inserts; (4) 1 pt. (0.47 L) inserts with split-lids	3 1/2" x 24" x 5 3/4" (89 x 610 x 146 mm)

Construction: 22-gauge stainless steel with high-impact plastic



B432

L1035

Plastic Tray Inserts & Accessories

- Make the most of your condiment center with interchangeable trays

Item	Description	Dimensions H x W x D
B416	1 pt. (16 oz.) (473 ml)	2 1/2" x 5" x 2 7/8" (64 x 127 x 73 mm)
B432	1 qt. (32 oz.) (946 ml)	5 7/8" x 2 3/4" x 5 1/2" (149 x 70 x 140 mm)
L1035	Stir stick/Straw caddy	4 1/2" x 5" x 3" (114 x 127 x 76 mm)

Construction: High-impact plastic

BAR TOOLS

- Smart solutions to make bar service more efficient
- Designed by bartenders for bartenders

Kleen Plug™

- Protects beer taps and bottles from fruit flies and other contaminants
- Affordable and easy-to-use
- Also seals and protects beverage station drains



Item	Description	Quantity
KLP200	Kleen Plug™ Blister Pack	5
KLP250	Bulk Kleen Plugs™	50

Construction: High-impact plastic

Bar Boards

- Durable co-polymer construction provides superior heat, chemical and warp resistance
- Material won't dull knives and resists unsanitary cut-grooving
- Smaller size is ideal for garnish prep at bar area

Item	Color	Dimensions H x W x D
CBG6938*	BK, GN, RD, WH, YL	6" x 9" x 3/8" (152 x 229 x 9.5 mm)
CB6912WH	WH	6" x 9" x 1/2" (152 x 229 x 13 mm)



CBG6938RD

CB6912WH



Non-Alcoholic Bar Mat

- Designate a reserved area to place non-alcoholic beverages for consumers who did not order an alcoholic drink
- Made of nitrile rubber, these mats are non-slip to keep the glasses in place and the counter-top clean

Item	Dimensions H x W x D
BM1018	10" x 18" x 1/4" (254 x 457 x 6.35 mm)



Saf-T-Ice® Bottle Guardian

- Safely chills wine and liquor bottles inside of ice bin
- Can be mounted inside or outside ice bin, keeping non-chilled bottles handy
- Durable construction; dishwasher safe

Item	Description
INCLUDED MOUNTING TOOLS: (1) MOUNTING BRACKET, (2) WIRE HANGING BRACKETS	
SI7000BG	(1) Guardian holder with removable drainage cap. (1) Set mounting tools; Max bottle diameter 3 3/4"

Construction: Polycarbonate



* Specify desired color after item number. Example: CBG6938BK





B5522



HANGER STRAPS

Hanger Straps can be used only with the single stainless speed rails. Offers portability for multiple uses. Made of durable stainless steel.

B500

Stainless Steel Speed Rails

- Attractive and durable stainless steel construction
- Available in single and double rails
- Holds quart and liter bottles

Item	Description	Dimensions H x W x D
B5522	Holds (5) 1 qt. (0.95 L) bottles	6" x 21¼" x 4¾" (152 x 540 x 105 mm)
B5532	Holds (8) 1 qt. (0.95 L) bottles	6" x 31½" x 4¾" (152 x 791 x 105 mm)
B5542	Holds (10) 1 qt. (0.95 L) bottles	6" x 41¼" x 4¾" (152 x 1048 x 105 mm)
B500	Hanger Straps for Single Speed Rails	
B5522D	Holds (10) 1 qt. (0.95 L) bottles	5⅞" x 18" x 5⅞" (149 x 457 x 137 mm)
B5532D	Holds (16) 1 qt. (0.95 L) bottles	5⅞" x 18" x 5⅞" (149 x 457 x 137 mm)
B5542D	Holds (20) 1 qt. (0.95 L) bottles	12¾" x 20⅞" x 12" (324 x 530 x 305 mm)

Construction: 22-gauge stainless steel



B5624SG

Wire Speed Rails

- Durable silver granite finish will not rust
- Holds quart and liter bottles
- Economical, ideal for outdoor use

Item	Description	Dimensions H x W x D
B5624SG	Holds (6) 1 qt. (0.95 L) bottles	6" x 24" x 4½" (152 x 610 x 114 mm)
B5636SG	Holds (9) 1 qt. (0.95 L) bottles	6" x 36" x 4½" (152 x 914 x 114 mm)

Construction: Heavy gauge formed wire



Bottle Cap Catcher

- Mounts easily under any bottle cap opener
- Durable stainless steel construction for years of use

Item	Dimensions H x W x D
B4300	13½" x 5⅞" x 3¼" (333 x 137 x 83 mm)

Construction: 22-gauge stainless steel



Bar Caddy

- Holds cocktail napkins, straws, stir sticks and more

Item	Dimensions H x W x D
B400BK	4½" x 9¼" x 5½" (105 x 235 x 140 mm)

Construction: High-impact plastic

Versa-Mat®

- Versatile interlocking mats to line shelves and sinks
- Design allows for sanitary airflow under glassware
- Flexible and easy to cut to any shape or size

Item	Color	Description	Dimensions H x W
VM5280*	BK, CL, RD, WN	Interlocking Bar Matting	12" x 12" (305 x 305 mm)
VM5280*-12	BK, CL, RD, WN	Interlocking Bar Matting 12 pk	12" x 12" (305 x 305 mm)

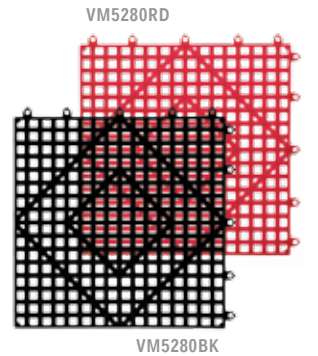

VM5280BK



Versa-Mat® Strips

- Sized in interlocking strips to fit under beer taps

Item	Color	Description	Dimensions H x W
VM5180BK	Black	Interlocking Bar Matting	3½" x 12" (89 x 305 mm)



Ultraliner™

- Pliable, soft plastic shelf liner
- Protects glassware from breakage
- Matte finish is available in three colors

Item	Color	Dimensions H x W
UL510*	3 (Clear), 4 (White), 5 (Black)	2' x 10' (61 x 305 cm)
UL540*	3 (Clear), 5 (Black)	2' x 40' (61 x 1219 cm)



UL5405

Poly-Liner™

- Pliable, soft plastic shelf liner
- Protects glassware from breakage
- Glossy finish is available in three colors

Item	Color	Dimensions H x W
PL010*	3 (Clear), 5 (Black)	2' x 10' (61 x 305 cm)
PL040*	3 (Clear), 5 (Black)	2' x 40' (61 x 1219 cm)



PL0403

SHELF MATTING

- Protect glassware from breakage and contamination
- Options and colors for every application

* Specify desired color after item number. Example: UL5103

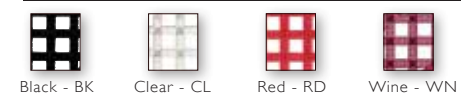

FOOD MANAGEMENT

FOOD STORAGE | CHEF TOOLS | CONDIMENT CENTERS | PUMP CENTERS | DESSERT

FOOD STORAGE

- Patented stackable design of ModPans™ allow you to keep refrigerated and dry foods conveniently organized and utilize maximum storage space



ModPans™

- ModPans™ include friction fit lids that keep food safe, eliminating the need for wrapping pans with messy plastic wrap or aluminum foil
- Fits in standard make/prep tables – direct from refrigerator to table, making this a convenient solution for any kitchen
- Made of odor and stain resistant transparent polypropylene in Gastronorm sizes, as specified in the EN 631 standards, available in 1 quart, 2 quart 4 quart, and 9 quart pans
- NSF approved, microwave & dishwasher safe

Item	Description	Capacity	Quantity
MP19	½ food pan with lid - 5½" (384 mm) deep	1 quart (.95 L)	1
MP19P	½ food pan (pan only) - 5½" (384 mm) deep	1 quart (.95 L)	1
MP16	½ food pan with lid - 4½" (105 mm) deep	2 quart (1.9 L)	1
MP16P	½ food pan (pan only) - 4½" (105 mm) deep	2 quart (1.9 L)	1
MP14	¼ food pan with lid - 6½" (165 mm) deep	4 quart (3.8 L)	1
MP14P	¼ food pan (pan only) - 6½" (165 mm) deep	4 quart (3.8 L)	1
MP13	⅓ food pan with lid - 5½" (140 mm) deep	4 quart (3.8 L)	1
MP13P	⅓ food pan (pan only) - 5½" (140 mm) deep	4 quart (3.8 L)	1
MP12	½ food pan with lid - 6" (152 mm) deep	9 quart (8.6 L)	1
MP12P	½ food pan (pan only) - 6" (152 mm) deep	9 quart (8.6 L)	1
RETAIL PACKS			
MP19RD	½ food pan with lid - retail packaged	1 quart (.95 L)	3
MP16RD	½ food pan with lid - retail packaged	2 quart (1.9 L)	3
MP14RD	¼ food pan with lid - retail packaged	4 quart (3.8 L)	2
MP13RD	⅓ food pan with lid - retail packaged	4 quart (3.8 L)	2
MP12RD	½ food pan with lid - retail packaged	9 quart (8.6 L)	2

Construction: Polypropylene



“ Ever since we started using ModPans we found that they help to eliminate waste and keep our kitchen very organized. They are great, they're stackable, they're awesome!

~ Manuel A.





Cheese Cloth

- High-grade, 100% lintless cotton
- Silicone-free, biodegradable and incinerable
- Perfect for preserving cheese, straining, steaming poaching, as well as cleaning and polishing

Item	Grade	Description	Dimensions
G-10	Grade 10	Food grade cheese cloth bulk packaged	36" x 80 yards (0.9 x 73 m)
G-40	Grade 40	Food grade cheese cloth bulk packaged	36" x 70 yards (0.9 x 64 m)
G-80	Grade 80	Food grade cheese cloth bulk packaged	36" x 60 yards (0.9 x 55 m)
G-10-R	Grade 10	Food grade cheese cloth merchandiser packaged	4 sq. yards/package
G-40-R	Grade 40	Food grade cheese cloth merchandiser packaged	4 sq. yards/package

Lemon Cover

- Keeps lemon seeds and pulp out of food
- Elastic opening

Item	Description	Quantity
LC001	Covers a half or quarter lemon	100



Poly-Roll™ Rolling Pin

- Durable non-porous, stain-resistant material will not chip, crack or peel
- No cavities that could cause cross-contamination; dishwasher safe
- Can be chilled for increased stick-resistance

Item	Length
RP15	15" (381 mm) / 23" (584 mm) (including handles)
RP18	18" (457 mm) / 26" (660 mm) (including handles)



CHEF TOOLS

- Enhance culinary skills and image with professional, high-quality tools; designed with the Chef in mind

Professional Squeeze Bottles

- Professional-grade squeeze bottles for drizzling, pooling and plate decorating
- Ideal for travel, competitions, demos and more



Item	Description	Capacity	Quantity
P8048PK	Retail packaged squeeze bottles	4oz. (118 ml), 8oz. (237 ml)	(2) 4oz. (118 ml), (2) 8oz. (237 ml)
P8012PK3	Retail packaged squeeze bottles	12oz. (355 ml)	3
P8024PK3	Retail packaged squeeze bottles	24oz. (710 ml)	3
P8004	Squeeze bottle (drizzling, plating and decorating)	4oz. (118 ml)	1
P8008	Squeeze bottle (drizzling, plating and decorating)	8oz. (237 ml)	1
P8012	Squeeze bottle (plating, saucing and storing)	12oz. (355 ml)	1
P8024	Squeeze bottle (plating, saucing and storing)	24oz. (710 ml)	1

P8012PK3



8" (203 mm) Combo Sharpening Stone

- Reversible carbon oxide sharpener
- Gray side has course 150 grit; Orange side has fine 400 grit
- Strong rubber-grip holder

Item	Length
CB1008	8" (203 mm)



Shown with 400 grit

Shown with 150 grit

Butcher's Trussing Twine

- For trussing and tying poultry, ham, seasoning bouquets and more

Item	Ply	Breaking	Dimensions
BT12	12 ply	26 lbs.	3600' (1097 m) per cone
BT30	30 ply	65 lbs.	1625' (495 m) per cone



Lettuce Knife

- Durable nylon material is dishwasher safe
- Serrated edge cuts without "browning" lettuce

Item	Length
LK200W	12" (305 mm) including handle





BD4004

See page 83 for more condiment trays

The Dome® Condiment Center

- Patented, domed lid rotates back for easy access and increased capacity when closed
- Use standard size trays to keep food chilled or deep trays for extra capacity

Item	Center Includes	Capacity
BD4003	(3) 2 qt. (1.9 L), (2) handles	6 qt. (5.6 L)
BD4004	(4) 3 pt. deep trays (1.4 L), (2) handles	6 qt. (5.6 L)
BD4014	(4) 1.5 pt. standard trays (.7 L), (2) handles	3 qt. (2.8 L)

Construction: High-impact resistant plastic



CONDIMENT CENTERS

- Portable, durable condiment serving for a neat, organized countertop
- Enhances image and maximizes efficiency; chillable options available



BD2001

Mini Dome® Condiment Centers

- Patented, domed lid design in a smaller size; notched lid option
- Connectors provide modularity between Mini Dome®, Dome® and snap-on caddies

Item	Description	Capacity
EACH MINI DOME® COMES WITH (2) END CAPS AND (1) CONNECTOR		
BD2001	(1) 2 qt. (1.9 L) deep tray	2 qt. (1.9 L)
BD2002	(1) 1 qt. (.95 L) standard tray	1 qt. (0.95 L)
BD2003	(2) 1 pt. (0.47 L) standard trays	2 pt. (0.47 L)
BD2002CAR	(1) 1 qt. (0.95 L) standard tray (with caddy)	1 qt. (0.95 L)
BD2004CAL	(2) 1.5 pt. (0.71 L) trays (with left hand caddy)	3 pt. (1.4 L)
BD2004NL	(2) 1.5 pt. (0.71 L) deep trays (notched domed lid)	3 pt. (1.4 L)

Construction: High-impact resistant plastic



Dome® Stacker

- Allows you to customize a configuration using Dome® and Mini Dome® to fit virtually any space
- Makes your operation more efficient, more organized and more professional



BDS2204NL

Item	Description	Capacity
BDSX100	Dome® Stacker Conversion Kit - converts your Dome® and Mini Dome® into a versatile, organized garnish center (Dome and Mini Dome not included)	
BDS2203	Dome® Stacker - 1/1 Mini Dome: (4) 1 pt. trays & bonus (2) 2 qt. trays	4 qt. (3.8 L)
BDS2204NL	Dome® Stacker - 1/1 Mini Dome: (4) 1.5 pt. deep trays - notched lids & bonus (2) 2 qt. trays	4.5 qt. (4.25 L)
BDS2401NL	Dome® Stacker - 2/2 Mini Domes: (4) 2 qt. deep Trays	8 qt. (7.6 L)
BDS2483NL	Dome® Stacker - 2/2 Mini Domes: (4) 1.5 pt. deep trays, (4) 1 pt. standard trays, (2) notched lids & (2) standard lids	5 qt. (4.7 L)
BDS4206	Dome® Stacker - 1/1 Dome®: (12) 1 pt. standard trays	6 qt. (5.6 L)
BDS4266	Dome® Stacker - 1/1 Dome®: (3) 2 qt. deep trays, (6) 1 pt. standard trays (chillable)	9 qt. (8.5 L)

Construction: High-impact resistant plastic



EZ-Chill™ Self-Service Center

- Flex-Lid System allows multiple lid positions
- Interchangeable food pans; use with EZ-Chill™ Ice Packs for cold-holding
- Stainless steel design is durable for years of use

Item	Description	Dimensions H x W x D
FP8244FL	(4) 1/6 pans, (2) Flex-Lids, (1) Ice liner	8" x 25½" x 7½" (203 x 638 x 194 mm)
FP8245NL	(4) 1/6 pans, (4) Notched Flex-Lids, (1) Ice liner (4) EZ-Chill™ packs	8" x 25½" x 7½" (203 x 638 x 194 mm)

Construction: 22-gauge stainless steel



FP8244FL

EZ-Chill™ Food Prep Center

- Replaceable, easy-to-clean food trays, use with EZ-Chill™ Ice Packs for cold-holding
- Flex-Lid System allows multiple lid positions
- Stainless steel design is durable for years of use

Item	Description	Dimensions H x W x D
FP9248FL	(8) ½ pans, (4) Flex-Lids, (2) Ice liners, (8) EZ-Chill™ packs	8" x 25¼" x 16½" (203 x 641 x 419 mm)

Construction: 22-gauge stainless steel



EZ-Chill™ Condiment Center with Tongs/Spoons

- Individual lids protect condiments from contaminants, for use with EZ-Chill™ Ice Packs
- Clear plastic tongs or spoons included

Item	Description	Dimensions H x W x D
B8143IL	(3) 2½ qt. (2.4 L) jars, (3) Individual lids, (3) Tongs, (3) EZ-Chill™ packs	9" x 14¾" x 8½" (229 x 371 x 216 mm)
FP9125FL	(3) ½ pans & spoons, (2) ½ pans, tongs & ice liners, (4) EZ-Chill™ packs	8" x 12¾" x 16¼" (203 x 324 x 413 mm)

Construction: 22-gauge stainless steel



B8143IL

EZ-Chill™ Refreezable Ice Packs

- Freeze ahead for up to five hours of chilling
- Easier and cleaner than using ice

Item	Description	Quantity
B6180	Refreezable ice packs	6



EZ-Chill™ Condiment Center with Individual Notched Lids



- Transparent, individual notched lids accommodate spoons while protecting condiments from spills and contaminants
- Attractive stainless steel construction for years of use

Item	Description	Dimensions H x W x D
B6183INL	(3) 1 qt. (0.95 L) inserts with notched lids; (1) Ice liners; (3) EZ-Chill™ packs	57½" x 18" x 5¾" (149 x 457 x 137 mm)

Construction: 22-gauge stainless steel

EZ-Chill™ Stepped Center with Individual Notched Lids



- Stepped design allows for maximum capacity within easy reach
- Transparent, notched lids easily accommodate spoons and keep condiments protected
- Attractive stainless steel construction for years of use

Item	Description	Dimensions H x W x D
B6706INL	(6) 1 qt. (0.95 L) inserts with notched lids; (2) Ice liners; (6) EZ-Chill™ packs	12¾" x 18" x 12" (321 x 457 x 305 mm)

Construction: 22-gauge stainless steel

Condiment Center with Individual Notched Lids



- Transparent, individual notched lids accommodate spoons while protecting condiments from spills and contaminants
- Attractive stainless steel construction for years of use

Item	Description	Dimensions H x W x D
B4061INL	(1) 1 qt. (0.95 L) inserts with individual notched lids	3½" x 6" x 5¾" (89 x 152 x 146 mm)
B4122INL	(2) 1 qt. (0.95 L) inserts with individual notched lids	3½" x 12" x 5¾" (89 x 305 x 146 mm)

Construction: 22-gauge stainless steel

Stepped Center with Individual Notched Lids



- Transparent, individual notched lids accommodate spoons while protecting condiments from spills and contaminants
- Attractive stainless steel construction for years of use

Item	Description	Dimensions H x W x D
B4702INL	(2) 1 qt. (0.95 L) inserts with individual notched lids	8" x 6½" x 12" (203 x 156 x 305 mm)
B4704INL	(4) 1 qt. (0.95 L) inserts with individual notched lids	8" x 12" x 12" (203 x 305 x 305 mm)
B4706INL	(6) 1 qt. (0.95 L) inserts with individual notched lids	8" x 18½" x 12" (203 x 460 x 305 mm)

Construction: 22-gauge stainless steel

FrontLine™ Universal Countertop Box System

- Dispenses from gallon jar, #10 can, Cryovac® bag and direct pour
- Soft-Touch™ pump delivers smooth, effortless dispensing
- Attractive stainless steel construction for years of use

Item	Color	Dimensions H x W x D
(1) PUMP BOX WITH TAMPER RESISTANT LID, PUMP, CONDIMENT LINER, CRYOVAC® BAG ADAPTER & PLUG, DIP TUBE.		
P4900	Metal Finish	without pump: 12¼" x 7½" x 10" (311 x 191 x 254 mm) with pump: 21½" x 7½" x 12½" (546 x 191 x 318 mm)
P4900BK	Black	without pump: 12¼" x 7½" x 10" (311 x 191 x 254 mm) with pump: 21½" x 7½" x 12½" (546 x 191 x 318 mm)

Construction: (Box/Lid) 22-gauge stainless steel

(Pump) High-impact plastic



P4900

PUMP CENTERS

- Dispense liquid condiments, sauces and syrups with ease
- Available in counter-top and in-counter options

FrontLine™ Universal In-Counter Condiment System

- Dispenses from gallon jar, #10 can, Cryovac® bag and direct pour
- Soft-Touch™ pump delivers smooth, effortless dispensing
- Attractive stainless steel construction for years of use

Item	Color	Counter Hole Diam.	Dimensions H x W x D
(1) UNIVERSAL CONDIMENT DISPENSER WITH PUMP, TAMPER RESISTANT LID, IN-COUNTER LINER, CRYOVAC® BAG ADAPTER & PLUG, DIP TUBE.			
P4100	Metal Finish	8.5" w x 6.5" h (216 x 165 mm)	without pump: 12" x 7½" x 9½" (305 x 191 x 241 mm) above counter with pump: 9¾" x 7½" x 9½" (248 x 191 x 241 mm)
P4100BK	Black	8.5" w x 6.5" h (216 x 165 mm)	without pump: 12¼" x 7½" x 10" (311 x 191 x 254 mm) with pump: 21½" x 7½" x 12½" (546 x 191 x 318 mm)

Construction: 22-gauge stainless steel; High-impact plastic



P4100

FrontLine™ 7qt. Round Cover & Pump System

Item	Color	Dimensions H x D
(1) SOFT-TOUCH™ PUMP AND COVER FOR 7-QUART ROUND INSET		
P4710	Metal Finish	Container: 8½" x 9½" (206 x 241 mm) with inset container (to be ordered separately)
P4710BK	Black	Container: 8½" x 9½" (206 x 241 mm) with inset container (to be ordered separately)

Construction: (Lid) 22-gauge stainless steel; (Pump) High-impact plastic



P4710

P/N	Cryovac® Bag	Gallon Jar	#10 Can	#10 Jar	Direct Pour
P4100	•	•	•	•	•
P4800	•	•	•	•	•
P4900	•	•	•	•	•

FRONTLINE™ CONDIMENT SYSTEMS

- Most versatile system on the market
- Sleek, low-profile design is durable and reliable
- Ensures smooth, effortless dispensing, and trouble-free maintenance

* Cryovac® is a registered trademark of Cryovac, Inc., a subsidiary of Sealed Air Corporation



P4800

FrontLine™ Countertop Box System

- Soft-Touch™ pump delivers smooth, effortless dispensing
- Dispenses from gallon jar, #10 can and direct pour

Item	Color	Capacity	Dimensions H x W x D
(1) PUMP BOX WITH TAMPER RESISTANT LID, PUMP AND CONDIMENT LINER			
P4800	Metal Finish	7 qt. (6.6 L)	without pump: 11" x 7" x 7" (279 x 178 x 178 mm) with pump: 20¼" x 7" x 7" (514 x 178 x 178 mm)
P4800BK	Black	7 qt. (6.6 L)	without pump: 11" x 7" x 7" (279 x 178 x 178 mm) with pump: 20¼" x 7" x 7" (514 x 178 x 178 mm)

Construction: 22-gauge stainless steel; High-impact plastic



P4826

FrontLine™ Countertop Dual Condiment System

- Stepped trays have a capacity of 1 quart (0.95 L) each
- Each pump box dispenses gallon jar, #10 can or direct pour
- Soft-Touch™ pump delivers smooth, effortless dispensing

Item	Color	Dimensions H x W x D
(2) PUMP BOX SYSTEMS (EITHER P4800 OR P4800BK) AND (1) STEPPED TRAY B47021NL		
P4826	Metal Finish	without pumps: 11" x 20½" x 12" (279 x 511 x 305 mm) with pumps: 20¼" x 20½" x 12" (514 x 511 x 305 mm)
P4826BK	Black	without pumps: 11" x 20½" x 12" (279 x 511 x 305 mm) with pumps: 20¼" x 20½" x 12" (514 x 511 x 305 mm)

Construction: (Box and Stepped Tray) 22-gauge stainless; (Lid) 22-gauge stainless; (Pump) High-impact plastic



P4000BK

P417

FrontLine™ Pumps & Accessories

- Pumps deliver smooth, effortless dispensing

Item	Color	Description
P4000BK	Black	Pump Only (for use with FrontLine systems only)
P417	Gray	7-quart round inset container for use with P4710 and P4710BK systems; 9½" (241 mm) diameter; 7 quart (6.65 L) capacity

Construction: (Box and Stepped Tray) 22-gauge stainless; (Lid) 22-gauge stainless; (Pump) High-impact plastic



P9800

EZ-Chill™ Condiment Pump Boxes

- Accommodates 1-gallon (4 liter) jar, or #10 can
- Features ice liner and includes (1) EZ-Chill™ Ice Pack
- Includes label packet for easy identification of condiments

Item	Description	Dimensions H x W x D
(1) PUMP BOX WITH ULTRA PUMP, ICE LINER, LABEL PACKET & EZ-CHILL™ PACKS		
P9800	For 1 gallon jar	17¼" x 7" x 7½" (438 x 178 x 181 mm)
P9810	For #10 can or jar	14½" x 7" x 7½" (267 x 178 x 181 mm)

Construction: 22-gauge stainless steel

Self-Service Condiment Center

- High-volume, economical condiment dispensing in attractive stainless steel
- Transparent, individual notched lids accommodate spoons while keeping condiments protected from contaminants
- Ultra Pumps dispense a variety of sauces, dressings and toppings

Item	Description	Dimensions H x W x D
P9724	(4) 1 qt. (0.95 L) inserts with notched lids & spoons (2) 2½ qt. (2.4 L) black jars with Ultra Pumps (1) label packet	14" x 22½" x 12½" (356 x 572 x 308 mm)
P9725	(4) 1 qt. (0.95 L) inserts with notched lids & spoons (2) 2½ qt. (2.4 L) black jars with Ultra Pumps (1) label packet	14" x 16¾" x 12½" (356 x 425 x 308 mm)

Construction: 22-gauge stainless steel



P9724

Pump & Condiment Tray Center

Item	Description	Dimensions H x W x D
P9724	(2) 2½ qt. (2.4 L) jars with Ultra Pumps (2) 2½ qt. (2.4 L) jars with lids & tongs	9" x 19½" x 8" (229 x 486 x 203 mm)
P9725	(2) Pump boxes with Ultra Pumps (2) 1 qt. (.95 L) inserts with spoons (1) label packet (2) EZ-Chill™ packs	14¾" x 20½" x 12" (375 x 511 x 305 mm)
P9825	(2) Pump boxes with Ultra Pumps (4) 1 qt. (.95 L) inserts with spoons (1) label packet (2) EZ-Chill™ packs	14¾" x 26½" x 12" (375 x 664 x 305 mm)

Construction: 22-gauge stainless steel



P9825

Condiment Pump Service Centers

- Perfect for self-service areas where portion control is critical
- Ultra Pumps dispense in one ounce portions
- 2½ -quart jars are removable for easy cleaning and refilling

Item	Description	Dimensions H x W x D
P9712	(2) 2½ qt. (2.4 L) black jars with Ultra Pumps	12½" x 10½" x 7½" (318 x 257 x 200 mm)
P9713	(3) 2½ qt. (2.4 L) black jars with Ultra Pumps	12½" x 14" x 7½" (318 x 356 x 200 mm)
P9715	(5) 2½ qt. (2.4 L) black jars with Ultra Pumps	12½" x 24" x 7½" (318 x 610 x 200 mm)

Construction: 22-gauge stainless steel



P9715

Economy Pump & Pump Kit

- Dispenses one ounce portions
- Pump Kit includes 38, 89 and 110 mm size screw caps and Snap caps in 110 and 160 mm sizes

Item	Color	Description	Quantity
P7300	White	Dispenses 1 oz. (29.6 ml) portions	2 pumps bagged w/ header card
P7300BK	Black	Dispenses 1 oz. (29.6 ml) portions	2 pumps bagged w/ header card
P7310	White	Dispenses 1 oz. (29.6 ml) portions	1 pump & 5 caps bagged w/ header card

Construction: High-impact plastic



P7300BK

P7310



Mega Pump & Pump Kit

- Mega Pump is designed to handle thick and chunky condiments such as tartar sauce, bleu cheese dressing and salsa
- Dispenses in one ounce portions
- Pump Kit includes 38, 89 and 110 mm size screw caps and snap caps in 110 and 160 mm sizes

Item	Description	Quantity
P7400	Dispenses 1 oz. (29.6 ml) portions	2 pumps bagged w/ header card
P7410	Dispenses 1 oz. (29.6 ml) portions	1 pump & 5 caps bagged w/ header card

Construction: High-impact plastic



Ultra Pump & Pump Kit

- Ultra Pump's fixed nozzle will not move while pumping
- Dispense condiments, sauces, dressings and toppings in one ounce portions
- Kit includes screw caps

Item	Description	Quantity
P7500	Dispenses 1 oz. (29.6 ml) portions	2 pumps bagged w/ header card
P7510	Dispenses 1 oz. (29.6 ml) portions	1 pump & 5 caps bagged w/ header card

Construction: High-impact plastic



Stainless Steel Syrup Pump

- Easily disassemble for cleaning
- Durable stainless steel construction

Item	Description	Dimensions H x W x D
P8400	For use with the 2 1/2 Quart Fountain Jar (P9700BK)	10 1/8" x 4 3/8" x 7" (257 x 111 x 178 mm)

Construction: 22-gauge stainless steel



2 1/2 Quart Fountain Jar

- 2 1/2-quart fountain jar replaces any current jars in San Jamar's Condiment Centers

Item	Color	Description
P9700BK	Black	For use with the Stainless Steel Syrup Pump (P8400)

Construction: High-impact plastic



Stainless Steel Chocolate Pump

Item	Dimensions H x W x D
P8509	8 3/4" x 8 3/4" x 5 3/4" (210 x 210 x 146 mm)

Construction: 22-gauge stainless steel



Pump Jar Lid

Item	Description	Quantity
P9770	Designed to fit the fixed nozzle on the Ultra Pump	1 jar lid bagged with header card

Construction: 22-gauge stainless steel



DESSERT

- Tools designed to make frozen dessert service sanitary and efficient



Ice Cream Cone Dispenser

- Easily mounts onto any wall surface
- Includes (3) easy-to-change gaskets for cake, sugar or waffle cones
- Keeps cones fresh and protected from breaking

Item	Dimensions H x D
IC2200SM	30 3/8" x 6" (778 x 152 mm)

Construction: High-impact plastic



Shake Collars

- Protect cups from mixer damage
- Available in a wide variety of sizes; send in sample cup for perfect sizing

- Contact our Customer Care Representatives at 1-800-248-9826 or sjorders@sanjamar.com
- For inquiries outside the U.S. email: sjorders@sanjamar.com

Topping Bar

- Hinged stainless steel lids allow easy access to toppings, (3) stainless steel ladles included
- Notched jars accommodate ladles and are removable for cleaning and refilling
- Ultra Pumps dispense in one-ounce portions

Item	Description	Dimensions H x W x D
P9723	(2) 2 1/2 qt. (2.4 L) jars with Ultra Pumps (3) 2 1/2 qt. (2.4 L) jars with ladles	12 1/2" x 22 1/2" x 12 1/8" (318 x 610 x 197 mm)

Construction: 22-gauge stainless steel





CHECK MANAGEMENT

- Durable, long-lasting slide racks and wheels for effortless check management

KITCHEN MANAGEMENT

CHECK MANAGEMENT

FLATWARE MANAGEMENT

FOOD CARRIERS

FLOOR MATTING



Slide Check Racks

- Durable aluminum construction for long life
- Polished glass beads for smooth sliding
- Attractive, sleek design

Item	Length	Dimensions H x W x D
CK6512A	12" (305 mm)	2" x 12" x 3/4" (51 x 305 x 19 mm)
CK6518A	18" (458 mm)	2" x 18" x 3/4" (51 x 458 x 19 mm)
CK6524A	24" (610 mm)	2" x 24" x 3/4" (51 x 610 x 19 mm)
CK6530A	30" (762 mm)	2" x 30" x 3/4" (51 x 762 x 19 mm)
CK6536A	36" (915 mm)	2" x 36" x 3/4" (51 x 915 x 19 mm)
CK6544A	44" (1017 mm)	2" x 44" x 3/4" (51 x 1017 x 19 mm)
CK6548A	48" (122 mm)	2" x 48" x 3/4" (51 x 122 x 19 mm)
CK6560A	60" (1524 mm)	2" x 60" x 3/4" (51 x 1524 x 19 mm)

Construction: Anodized Aluminum; Bagged with header card

“ I purchased this for my high volume café coffee shop. We needed a system to prevent the tickets from flying around. This worked like a charm.

~ Jane J.

”



CK6016P

Check Wheels

- Display up to 16 checks at one time
- Available in a moveable pedestal style or mounted models
- Stainless steel clips will not rust and allow for easy one-handed check placement

Item	Description	Dimensions H x D
CK6016P	16 clips with pedestal	14¼" x 18½" (362 x 370 mm)
CK6016KT	16 clips with mounting kit	14¼" x 18½" (362 x 370 mm)

Construction: (Wheel) 22-gauge stainless steel; (Base) chrome-plated steel



FLATWARE MANAGEMENT

KatchAll® Flatware Scrap Block

- Designed for use at dish tables
- Strong magnet attracts discarded flatware
- Fits standard dish table openings from 5½" to 7" (140 mm to 180 mm) and is dishwasher safe

Item	Fits Dimensions (D x H)
KA600	7¼" x 4" (184 x 102 mm)

Condiment Spoons & Tongs

Item	Description	Volume
CONVENTIONAL STYLE		
P9776CL	Clear plastic spoons	½ oz. (14.7 ml)
P9777CL	Clear plastic tongs	n/a

P9776CL



KA4400

KatchAll® Flatware Retrievers

- Strong magnetic bar attracts flatware as it goes into the trash can
- Patented design fits on standard trash cans
- Meets health codes for closed refuse containers and is dishwasher safe

Item	Description	Dimensions H x W x D
FITS SLIM JIM® TRASH CONTAINER		
KA1950RD	Burgundy	9" x 20¾" x 11¾" (229 x 518 x 289 mm)
KA1951RD	Burgundy	6¾" x 20½" x 11¾" (165 x 514 x 289 mm)
BURGUNDY, ROUND		
KA2000	20 gal. (75.7 L)	20" x 9½" (500 x 241 mm)
KA3200	32 gal. (121 L)	22¾" x 10½" (565 x 267 mm)
KA3244	32 & 44 gal. (121 & 166.5 L)	25" x 9½" (635 x 241 mm)
KA4400	44 gal. (166.5 L)	25" x 8¾" (635 x 210 mm)
KA5500	55 gal. (189.2 L)	27" x 9¾" (686 x 229 mm)

NOTE: KatchAll Retrievers will not attract 18/8 or 18/10 silverware.



FC1212-RD



FC2212-RD

Insulated Food Carriers

- Features outside identity pocket
- Comfortable padded handles
- Zipper closure

Item	Dimensions H x W x D
FC1212-RD	12" x 12" x 12" (305 x 305 x 305 mm)
FC2212-RD	12" x 22" x 12" (305 x 559 x 305 mm)

Construction: Insulated with 1" foam padding and lined with extra tough water repellent nylon

FOOD CARRIERS

- Professional, durable insulated carriers help maintain food quality and temperatures during transport
- Options available for pizza boxes and sheet pans



PB17



PB25

Insulated Pizza Carriers

- Moisture-free insulation and lining
- Hanging loop for convenient storage option
- Stain resistant 600 denier shell

Item	Description	Dimensions H x W x D
PB17	Holds up to: (4) 12" Pizza Boxes or (3) 14" Pizza Boxes	5" x 16½" x 17" (127 x 419 x 432 mm)
PB20-6	Holds up to: (3) 16" Pizza Boxes or (3) 18" Pizza Boxes	6" x 18" x 20" (152 x 457 x 508 mm)
PB20-12	Holds up to: (6) 16" Pizza Boxes or (6) 18" Pizza Boxes	12" x 18" x 20" (305 x 457 x 508 mm)
PB25	Holds up to: (2) 24" Pizza Boxes	6" x 26" x 25" (152 x 660 x 635 mm)

FLOOR MATTING

- Reduce leg fatigue and increase safety
- Available for light to medium-duty for bar, server stations and kitchen applications

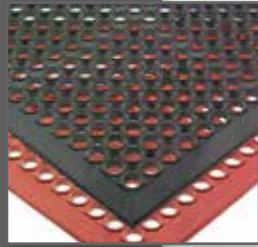

EZ-Mats LIGHT DUTY

- Provide a safe and comfortable walking and standing area for employees
- Engineered for excellent drainage

Item	Color	Description	Dimensions H x W x D
KM1100	Black	Non-Bagged	3' x 5' x ½" (91.4 x 152.4 x 1.3 cm)
KM1100B	Black	Bagged	3' x 5' x ½" (91.4 x 152.4 x 1.3 cm)
KM1200	Red	Non-Bagged	3' x 5' x ½" (91.4 x 152.4 x 1.3 cm)
KM1200B	Red	Bagged	3' x 5' x ½" (91.4 x 152.4 x 1.3 cm)



Tuf-Mats MEDIUM DUTY

- Designed for maximum support & durability in high traffic areas
- Circular pattern allows for drainage and easy clean-up
- High grade rubber resists wear and provides excellent traction

Item	Color	Description	Dimensions H x W x D
KM2100	Black	Non-Bagged	3' x 5' x ¾" (91.4 x 152.4 x 1.9 cm)
KM2100B	Black	Bagged	3' x 5' x ¾" (91.4 x 152.4 x 1.9 cm)
KM2200B	Red	Bagged	3' x 5' x ¾" (91.4 x 152.4 x 1.9 cm)

Connect-A-Mats LIGHT DUTY

- Connect together for floor secure matting
- Lightweight and easy to move
- Provides excellent foot support

Item	Color	Description	Dimensions H x W x D
KM1140B	Black	Bagged	3' x 3' x ½" (91.4 x 91.4 x 1.3 cm)
KM1240B	Red	Bagged	3' x 3' x ½" (91.4 x 91.4 x 1.3 cm)

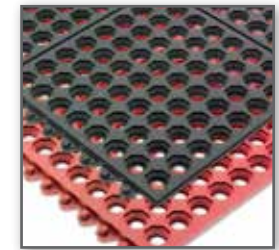

Anti-Fatigue Sponge Vinyl Mats

- Designed for dry areas
- Easy to clean with vacuum or broom
- Lightweight and easy to move

Item	Color	Description	Dimensions H x W
KM4100BK	Black	Bagged	27" x 36" (68.6 x 91.4 cm)
KM4360BK	Black	Bagged	3' x 60' (91.4 x 1828.8 cm)
KM4360GY	Gray	Bagged	3' x 60' (91.4 x 1828.8 cm)



PERSONAL SAFETY

Employee safety in the kitchen should always be top-of-mind.

Cuts and burns from exposure to extreme temperatures, cleaning solutions and sharp implements are a constant safety risk. Guard against bodily injuries with San Jamar's comprehensive line of personal protective gear.



TEMPERATURE
PROTECTION MITTS

TEMPERATURE
PROTECTION
GLOVES & SLEEVES

TEMPERATURE
PROTECTION
HOLDERS

CUT PROTECTION

CHEMICAL
PROTECTION



TEMPERATURE PROTECTION MITTS

HIGH PERFORMANCE

VALUE-ADDED

ECONOMY

HIGH PERFORMANCE

TEMPERATURE PROTECTION MITTS



KT0215



KT0115K

Cool Touch Flame™ Oven Mitt

- Flame resistant and extra durable due to Nomex® and Kevlar® surface
- Provides flame, heat and steam protection
- Integrated magnet allows for easy storage and immediate availability

Item	Length	Description	Temperature Protection
KT0212	13" (330 mm)	Conventional Style	Up to 535°F (280°C) for 30 sec
KT0215	15" (381 mm)	Conventional Style	Up to 535°F (280°C) for 30 sec
KT0218	17" (432 mm)	Conventional Style	Up to 535°F (280°C) for 30 sec
KT0224	24" (610 mm)	Conventional Style	Up to 535°F (280°C) for 30 sec
KT0112K	13" (330 mm)	Puppet Style	Up to 535°F (280°C) for 30 sec
KT0115K	15" (381 mm)	Puppet Style	Up to 535°F (280°C) for 30 sec
KT0118K	17" (432 mm)	Puppet Style	Up to 535°F (280°C) for 30 sec
KT0124K	24" (610 mm)	Puppet Style	Up to 535°F (280°C) for 30 sec



These are great oven mitts. I have a pair of my own and use them pretty much exclusively for all the baking I do. I never worry about burning my hands through the mitts and they are flexible enough that I feel like I always have a good grip on what I am holding.

~ David M.



Nomex® and Kevlar® are registered trademarks of DuPont



CTP15
With Built-in magnet

Cool Touch™ Oven Mitt

- Made with Kevlar® WebGuard™ for extra protection
- Provides heat and steam protection
- Integrated magnet allows for easy storage and immediate availability

Item	Length	Description	Temperature Protection
CTC*	13" (330 mm) 15" (381 mm) 17" (432 mm) 24" (610 mm)	Conventional Style	Up to 500°F (260°C) for 15 sec
CTP*	13" (330 mm) 15" (381 mm) 17" (432 mm) 24" (610 mm)	Puppet Style	Up to 500°F (260°C) for 15 sec



KM15

Oven Mitt with Kevlar®

- Durable, ambidextrous and ideal for handling abrasive items
- Made with fire retardant Kevlar®
- Machine washable

Item	Length	Color	Description	Temperature Protection
KM*	15" (381 mm) 17" (432 mm)	Gold	Conventional Style	Up to 500°F (260°C) for 30 sec

BestGrip® Oven Mitt

- Non-slip, textured Neoprene material repels stains and provides superior grip ability in hot applications
- Rinse in sink or wipe clean with damp cloth
- Integrated magnet allows for easy storage and immediate availability

Item	Length	Color	Description	Temperature Protection
810CM*	15" (381 mm) 17" (432 mm)	Tan/Black	Conventional Style	Up to 500°F (260°C) for 60 sec
810PM*	15" (381 mm) 17" (432 mm)	Tan/Black	Puppet Style	Up to 500°F (260°C) for 60 sec



810CM17
With WebGuard™
With Built-in magnet

Terry Oven Mitt

- Made with heavy-duty, institutional grade terry cloth
- Machine washable
- Steam barrier option available

Item	Length	Color	Description	Temperature Protection
8*TM	13" (330 mm) 17" (432 mm) 24" (610 mm)	Natural	Conventional Style	Up to 500°F (260°C) for 30 sec
817TM-BR	17" (432 mm)	Brown	Conventional Style	Up to 500°F (260°C) for 30 sec
8*TM-SB	13" (330 mm) 17" (432 mm)	Natural	With Steam Barrier	Up to 500°F (260°C) for 30 sec



813TM



With WebGuard™

UCMX17BK

UltiGrips® Oven Mitt

- Cleans easily in sink and is dishwasher safe
- Non-slip, textured Neoprene material repels stains and provides superior grip ability in hot or cold applications
- WebGuard™ for extra protection & comfort

Item	Length	Color	Description	Temperature Protection
UCMX*BK	13" (330 mm) 15" (381 mm) 17" (432 mm)	Black	Conventional Style	-109°F (-78°C) up to 500°F (260°C) for 15 sec
UPM*BK	15" (381 mm) 17" (432 mm)	Black	Puppet Style	-109°F (-78°C) up to 500°F (260°C) for 15 sec



* Specify desired size: Example: CTCI 3

Kevlar® is a registered trademark of DuPont

VALUE - ADDED

ECONOMY



BestGuard® Oven Mitt with Kevlar® WebGuard™

- Ambidextrous & fire retardant
- Kevlar® WebGuard™ for extra protection & comfort
- Wipes clean with a damp cloth

Item	Length	Color	Description	Temperature Protection
800FG*	13" (330 mm)	Tan	Conventional Style	Up to 450°F (232°C) for 30 sec
	15" (381 mm)			
	17" (432 mm)			
	24" (610 mm)			
800FG*-BK	13" (330 mm)	Black	Conventional Style	Up to 450°F (232°C) for 30 sec
	15" (381 mm)			
	17" (432 mm)			
	24" (610 mm)			



Wool Oven Mitt

- 100% cotton exterior with wool insulation
- Machine washable

Item	Length	Color	Description	Temperature Protection
OM17-GYW	17" (432 mm)	Gray	Conventional Style	Up to 450°F (232°C) for 30 sec



Bestan® Oven Mitt

- Rinses clean
- Non-stick coating

Item	Length	Color	Description	Temperature Protection
811TG*	13" (330 mm)	Tan	Conventional Style	Up to 450°F (232°C) for 15 sec
	15" (381 mm)			
	17" (432 mm)			

Tri-Flex Oven Mitt

- Separate index finger for dial or push button use
- Ambidextrous & fire retardant
- Wipes clean with a damp cloth

Item	Length	Color	Description	Temperature Protection
850TF17	17" (432 mm)	Tan	Separate index finger	Up to 400°F (205°C) for 15 sec



Silicone Oven/Freezer Mitt

- Rinses clean
- Non-stick coating
- Works well with hot or cold surfaces

Item	Length	Color	Description	Temperature Protection
801SG*	13" (330 mm)	Silver	Conventional Style	0°F (-18°C) up to 400°F (204°C) for 15 sec
	15" (381 mm)			
	17" (432 mm)			

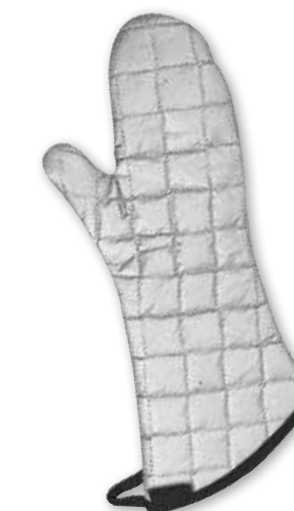

* Specify desired length after item number: Example: 800FG13

Kevlar® is a registered trademark of Dupont



HOT OIL GLOVES

- San Jamar's hot oil gloves are ideal for restaurant deep fryer grease applications and rotisserie pits
- The cotton flocked inner lining provides ease of slipping gloves on and off



6786RMT

Fryer Oven Mitt

- Liquid-proof, seamless construction
- Cotton flocked inner lining
- Machine washable

Item	Length	Materials	Temperature Protection
6786RMT	14" (356 mm)	Neoprene rubber	Up to 500°F (260°C) for 15 sec
6786RMT-XL	17" (432 mm)	Neoprene rubber	Up to 500°F (260°C) for 15 sec

TEMPERATURE PROTECTION GLOVES & SLEEVES

HOT OIL GLOVES

TEMPERATURE GLOVES

TEMPERATURE SLEEVES

“ These are nice heavy duty oven mitts that work perfectly for scrubbing a fryer after you drain it. The elements tend to stay hot and these gloves prevent burns. ”

~ Rick M.



T1212

The Rotissi Glove

- Ideal for use in rotisserie pits
- Cotton flocked inner lining

Item	Length	Materials	Temperature Protection
T12*	12" (305 mm), 17" (432 mm)	Neoprene rubber	Up to 500°F (260°C) for 15 sec

TEMPERATURE GLOVES



Hot Mill Knit Glove

- Excellent dexterity
- Knitted wrist for a tighter fit
- Grippy surface

Item	Size	Materials	Temperature Protection
ML5000	One size fits most	Heavy duty cotton	Up to 400°F (204°C) for 15 sec



Frozen Food Glove

- Easy on/off
- Non-stick surface
- Great dexterity

Item	Size	Materials	Temperature Protection
FGI-OR	One size fits most	PVC with cotton jersey liner	As low as 0°F (-18°C) for 60 sec



5312-M

White Waiter's Glove

- Fine stitching
- Great dexterity

Item	Size	Description	Materials
5312WH-*	M, L	Dotted palm for additional grip ability	Cotton
IG100	One size fits most	Clean, upscale look	Cotton

TEMPERATURE SLEEVES

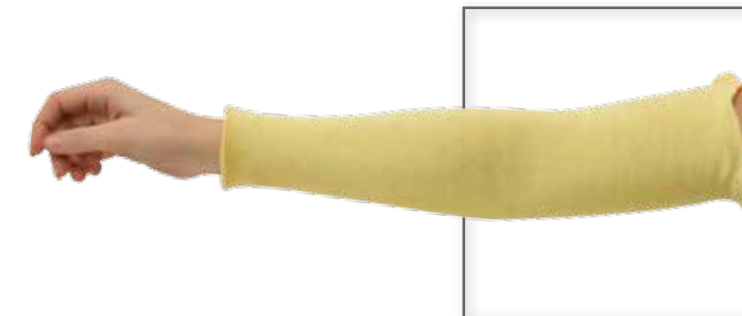

Sleeve with Kevlar®

- Protects forearm against inadvertent heat contact
- Machine washable

Item	Length	Materials	Temperature Protection
SLK16	18" (457 mm)	Kevlar®	Up to 500°F (260°C) for 15 sec



Terry Sleeve

- Knitted wrist
- Heavy duty institutional grade terry cloth
- Machine washable

Item	Length	Materials	Temperature Protection
SLWT16	18" (457 mm)	100% cotton terry	Up to 350°F (177°C) for 15 sec

* Specify desired length/size after item number. Example:T1212

Kevlar® is a registered trademark of DuPont

TEMPERATURE PROTECTION HOLDERS

POT HOLDERS

PAN GRABBERS

HANDLE HOLDERS

POT
HOLDERS

TEMPERATURE PROTECTION HOLDERS



Cool Touch Flame™ Hot Pads

- Flame, heat, and steam resistant due to Nomex® surface
- Wrist strap for ease of use
- Machine washable

Item	Size	Material	Temperature Protection
CTFHP88	8" x 8" (203 x 203 mm)	Nomex®	Up to 535°F (280 °C) for 30 sec

Nomex® is a registered trademark of DuPont



“ This hot pad is great because I don't have to worry about it catching on fire like previous hot pads I have used. It's also very flexible and I love that I can throw it in the washing machine. ~ Sarah N. ”



UltiGrips® Hot Pads

- Flexible and dishwasher safe
- Provides superior grip ability in hot or cold applications

Item	Size	Material	Temperature Protection
UHP55BK	5.5" x 5.5" (140 x 140 mm)	Non-slip, textured, Neoprene	Up to 500°F (260°C) for 15 sec
UHP77BK	7" x 7" (178 x 178 mm)	Non-slip, textured, Neoprene	Up to 500°F (260°C) for 15 sec
UHP1010BK	10" x 10" (254 x 254 mm)	Non-slip, textured, Neoprene	Up to 500°F (260°C) for 15 sec

Silicone Pot Holder

- Non-stick coating
- Wipes clean

Item	Size	Material	Temperature Protection
802SPH	7" x 7" (178 x 178 mm)	Cotton/Silicone	Up to 350°F (177°C) for 15 sec



BestGuard® Terry Pot Holder

- Hanging loop
- Two sided construction: non-stick BestGuard® on one side, terry on the other

Item	Size	Material	Temperature Protection
802TF	8" x 8" (203 x 203 mm)	BestGuard®/Terry cloth	Up to 500°F (260°C) for 30 sec

Round Pot Holder

- Hanging loop
- Machine washable

Item	Size	Material	Temperature Protection
813RPH	8" (203 mm)	Heavy duty terry cloth	Up to 500°F (260°C) for 30 sec



Terry Cloth Pot Holder

- Hanging loop
- Machine washable

Item	Size	Material	Temperature Protection
802TPH	8" x 8" (203 x 203 mm)	Heavy duty terry cloth	Up to 500°F (260°C) for 30 sec

Bestan® Pot Holder

- Non-stick coating
- Wipes clean

Item	Size	Material	Temperature Protection
812TPH	7" x 7" (178 x 178 mm)	Bestan®/Cotton	Up to 350°F (177°C) for 30 sec



PAN GRABBERS



Pan Grabber (BAKER'S PAD WITH SLIT)

- Convenient wrist slit for easier use
- Easy to use with sheet pans
- Machine washable

Item	Size	Material	Temperature Protection
835PG	10" x 11" (254 x 279 mm)	Terry cloth	Up to 500°F (260°C) for 30 sec



Pan Grabber (BAKER'S PAD)

- Machine washable
- Durable and economical

Item	Size	Material	Temperature Protection
823TPH	10" x 11" (254 x 279 mm)	Terry cloth	Up to 500°F (260°C) for 30 sec



Pan Grabber (BAKER'S PAD WITH WRIST STRAP)

- Elastic wrist strap
- Customize with your logo
- Machine washable

Item	Size	Material	Temperature Protection
803PG	9½" x 11" (241 x 279 mm)	Bestex™/Terry cloth	Up to 400°F (204°C) for 15 sec
803PG-LOGO	9½" x 11" (241 x 279 mm)	Bestex™/Terry cloth	Up to 400°F (204°C) for 15 sec

Customization Available: for imprinted version please call customer service for your personalized logo item number



Junior Pan Grabber (BAKER'S PAD WITH POCKET)

- Pouch pocket provides easy on/off
- Machine washable

Item	Size	Material	Temperature Protection
845PG	6" x 8" (152 x 203 mm)	Cotton/ Canvas	Up to 350°F (177°C) for 15 sec

HANDLE HOLDERS



BestGuard® Handle Holder

- Fire retardant coating
- Wipes clean with damp cloth

Item	Color	Size	Material	Temperature Protection
804BG	Tan	3¼" x 6½" (83 x 165 mm)	BestGuard®/Cotton	Up to 450°F (232°C) for 15 sec
804BG-BK	Black	3¼" x 6½" (83 x 165 mm)	BestGuard®/Cotton	Up to 450°F (232°C) for 15 sec

Bestan® Handle Holder

- Non-stick surface
- Wipes clean with damp cloth

Item	Color	Size	Material	Temperature Protection
804HH	Tan	3¼" x 6½" (83 x 165 mm)	Bestan®/Cotton	Up to 350°F (177°C) for 15 sec

Hand Safety Organizer

- Easily stores and grabs mitts magnetically
- Minimizes cross contamination

Item	Size	Description
HO1000	18" x 2" (457 x 51 mm)	Magnetic steel bar



CUT PROTECTION

CUT PROTECTION GLOVES

SAFETY AIDS

CUT PROTECTION GLOVES

- Cut-Resistant Gloves are available in many different materials including; Dyneema®-The world's strongest fiber™, Stainless Steel, Nylon Cord, and Natural Rubber
- Food safety colors allow for dedicated use, preventing cross contamination.
- ANSI Level 4 and ANSI Level 5 Cut-Resistant Gloves available
- Wristband color of glove indicates size

CUT PROTECTION



Cut-Resistant Glove with Dyneema®

WITH EXCLUSIVE DOUBLE GUARD™ ANTIMICROBIAL AGENT

- 10 gauge Dyneema fiber
- Ambidextrous, lightweight & machine washable
- ANSI Level 5 cut protection

Item	Color	Size	Length	Material	Cut Protection
SG10-*	White	S, M, L, XL	11" (279 mm)	Dyneema*** composite yarn	Meets OSHA standard (29 CFR) 1910.132 - Tested in accordance with ASTM Spec 177.20
SG10-**	Blue (BL) Green (GN) Red (RD) Yellow (Y)	S, M, L	11" (279 mm)	Dyneema*** composite yarn	Meets OSHA standard (29 CFR) 1910.132 - Tested in accordance with ASTM Spec 177.20



“ Easy to pair with my cutting board system for cross-contamination prevention. Very durable and I don't feel restricted when I use it. A better glove compared to others in the market. ”

~ Paul S.

* Specify desired size after item number. Example: SG10-S
 ** Specify desired color and size after item number. Example: SG10-BL-S
 *** Dyneema® is a registered trademark of Royal DSM N.V.
 Under license of Double D Knitting & Glove, Inc.



Stainless Steel Mesh Cut-Resistant Glove

- Non-corrosive & easy to clean
- Antimicrobial wrist strap
- Great for deboning

Item	Size	Material
MGA515*	XS, S, M, L, XL	Stainless steel mesh



Cut-Resistant Butcher Glove

WITH EXCLUSIVE DOUBLE GUARD™ ANTI-MICROBIAL AGENT

- 10 gauge yarn
- Ambidextrous, lightweight & machine washable
- ANSI Level 4 cut protection

Item	Size	Material	Cut Protection
PBS301-*	XS, S, M, L, XL	Stainless steel/ nylon cord	ANSI Level 4 cut protection



D-Shield™ Cut-Resistant Glove

- 10 gauge Dyneema® fiber
- Ambidextrous & machine washable
- ANSI Level 4 cut protection

Item	Size	Material	Cut Protection
DFG1000-*	S, M, L, XL	Dyneema®	ANSI Level 4 cut protection



Cut Glove with Kevlar®

- 10 gauge terry cloth and Kevlar fibers
- PVC dot coating for improved grip during tasks
- ANSI level 3 cut protection

Item	Size	Cut Protection
KG1000	One size fits most	ANSI Level 3 cut protection



Oyster Shucking Glove

- Liquid-proof, cotton lining and easy to clean
- Heavy duty latex palm coating
- Excellent wet or dry grip

Item	Size	Material
1000	One size fits most	Natural rubber latex/cotton

* Specify desired size after item number. Example: MGA515XS
Dyneema® is a registered trademark of Royal DSM N.V. Under license of Double D Knitting & Glove, Inc.

SAFETY AIDS

BreadGuard™

- Provides a safe and sanitary barrier between one's hand and the food
- Ribbed grips for improved gripping ability
- Provides cut protection

Item	Color	Quantity
BG100	Red	1 each



Klever Cutter™ Carton Opener

- Tough high-density plastic with stainless steel safety-type blades
- No need to change blades
- Prevents costly injuries to employees and damage to products

Item	Color	Description
KK401	Red	(1) Klever Cutter
KK401BL	Blue	(1) Klever Cutter
KK401YL	Yellow	(1) Klever Cutter
KK403	Red	3 piece retail pack



KK401



Mani-Kare™ Bandages

- Latex-free
- Flexible & breathable
- Non-food blue colored bandages are easy to see



Blue bandages are easy to see, so you won't serve contaminated food - a food safety disaster!

Item	Shape	Description	Dimensions L x W	Quantity
MK0901		Strip bandages	7/8" x 3" (22 x 76 mm)	300 bandages (6 boxes of 50)
MK0902		Small fingertip bandages	1 3/4" x 2" (45 x 51 mm)	240 bandages (6 boxes of 40)
MK0903		Knuckle bandages	1 3/4" x 3" (45 x 76 mm)	240 bandages (6 boxes of 40)
MK0904		Large fingertip bandages	1 3/4" x 3" (44 x 76 mm)	150 bandages (6 boxes of 25)
MK0905		Large Patch bandages	2" x 3" (51 x 76 mm)	150 bandages (6 boxes of 25)
MK0906	Assorted	Value pack: 2 boxes of MK0901; 1 box of MK0902; 1 box of MK0903; 1 box of MK0904; 1 box of MK0905	Assorted	100 strips (2 boxes), 40 small fingertips (1 box), 40 knuckles (1 box), 25 large fingertips (1 box) & 25 large patches (1 box)
MK0909	Assorted	1 storage box with 1 MK0906	Assorted	Storage box with 100 strips (2 boxes), 40 small fingertips (1 box), 40 knuckles (1 box) & 25 large fingertips (1 box) & 25 large patches (1 box)



CHEMICAL PROTECTION

GLOVES

GLOVES

UTILITY APRONS

SPLASH RESISTANT APRONS

CHEMICAL PROTECTION



Nitrile Glove

- 22 mil
- Protects to 185°F (85°C)
- Protection against abrasions, punctures and chemicals

Item	Size	Length	Material	Temperature Protection
19NU-*	S, M, L, XL	19" (482 mm)	Nitrile rubber	Protects to 185°F (85°C)



“ These are a really great pair of pot washing gloves. They are good to have in the kitchen when heavy-duty cleaning involving corrosive chemicals is taking place.

~ Tom M.



* Specify desired size after item number. Example: 19NU-S



Nitrile Flock Lined Glove

- Embossed grip
- 15 mil
- FDA compliant (21CFR, 170-199)

Item	Size	Length	Material	Temperature Protection
13NU-*	M, L	13" (330 mm)	Nitrile rubber/flock	Up to 195°F (91°C)



Neoprene Flock Lined Glove

- 30 mil, cotton flocked lining & embossed grip
- FDA compliant
- Resistant to chlorinated solvents, inorganic acids and petroleum products

Item	Size	Length	Material	Temperature Protection
238SF-*	M, L	15½" (330 mm)	Neoprene	Up to 185°F (85°C)



Latex Flock Lined Glove

- 18 mil
- Embossed grip
- FDA compliant (21CFR, 170-199)

Item	Size	Material
620-*	S, M, L, XL	Natural rubber latex



Heavy Duty Neoprene & Latex Glove

- 28 mil, flock lined and tear resistant with embossed grip
- Resistant to caustics, alcohols, acids, & detergents
- FDA compliant (21CFR, 170-199)

Item	Size	Material
720-*	S, M, L, XL	Neoprene & latex blend



Heavy-Duty Rubber Glove

- 40 mil, unlined with embossed grip
- Resistant to light chemicals
- Thick & flexible

Item	Size	Length	Material
R93517	One size fits most	17" (432 mm)	Natural rubber

ProGrip™

- Cut and abrasion resistant
- FDA compliant (21CFR, 170-199)

Item	Size	Length	Material
CP14-*	S, M, L, XL	14" (356 mm)	Nitrile/cotton liner



Neoprene Shoulder-Length Glove

- Liquid Proof
- FDA compliant (21CFR, 170-199)
- Full arm protection for chemical or food processing protection

Item	Size	Length	Material	Temperature Protection
P31	One size fits most	31" (787 mm)	Neoprene	Up to 185°F (85°C)



PVC Glove

- Interior cotton interlock lining
- Rough grip for improved handling
- Oil and chemical resistant

Item	Size	Length	Material	Temperature Protection
884	One size fits most	14" (355 mm)	PVC/Cotton	Up to 185°F (85°C)
887	One size fits most	18" (457 mm)	PVC/Cotton	Up to 185°F (85°C)



Neoprene Glove

- Liquid proof & steam resistant
- Jersey-lined for extra heat protection
- Coated with protective Neoprene rubber

Item	Size	Length	Material	Temperature Protection
1214	One size fits most	14" (355 mm)	Neoprene	Up to 200°F (93°C)
1217EL	One size fits most	17" (432 mm)	Neoprene	Up to 200°F (93°C)



* Specify desired size after item number. Example: 13NU-M

UTILITY APRONS



615NBA-Y

Neo-Flex™ Bib Apron

- Heat-resistant, fire-retardant
- Durable and cut-resistant
- Repels liquid and grease
- Adjustable neck strap

Item	Color	Dimensions W x L	Material
615NBA-*	Y, BK	29" x 43" (73 x 109 cm)	Neo-Flex™



Disposable Bib Apron

- Lightweight
- Economical
- Durable

Item	Color	Dimensions W x L	Material
8706	White	28" x 46" (71 x 117 cm)	Polyethylene

SPLASH RESISTANT APRONS

Economy Vinyl Bib Apron

- A great look for a very affordable price

Item	Color	Dimensions W x L	Material
604VBA-E	Brown	25" x 28" (64 x 71 cm)	Vinyl

20 mil Vinyl Apron

- Protects against fats, liquids and abrasions
- Extra-long ties for added comfort

Item	Color	Thickness	Dimensions W x L	Material
614DVA20-GN	Green	20 mil	36" x 45" (91 x 114 cm)	Institutional grade quality vinyl
614DVA20-WH	White	20 mil	36" x 45" (91 x 114 cm)	Institutional grade quality vinyl

Vinyl Dish Washing Apron

- Includes heavy-duty braided ties

Item	Color	Thickness	Dimensions W x L	Material
614DVA-WH-**	White	6 mil, 8 mil	36" x 43" (91 x 109 cm)	Institutional grade quality vinyl
614DVA-BL-8	Blue	8 mil	36" x 43" (91 x 109 cm)	Institutional grade quality vinyl
614DVA-12	Clear	12 mil	36" x 43" (91 x 109 cm)	Institutional grade quality vinyl

Vinyl Bib Apron

- Heavyweight
- Waterproof and fire-retardant

Item	Color	Length	Dimensions W x L	Material
604VBA-BR	Brown	Regular	25" x 28" (64 x 71 cm)	Vinyl
604VBA37-BR	Brown	Long	25" x 37" (64 x 94 cm)	Vinyl

* Specify desired color after item number. Example: 615NBA-Y

** Specify desired thickness after item number. Example: 614DVA-WH-6



614DVA20-GR



614DVA-BL



604VBA-BR

P9713	97	RCU1282	62	SICART61	58	T8400TBL	9
P9715	97	RCUBRKT	62	SLK16	117	T8400WH	9
P9723	99	RCUCAPPAK	62	SLWT16	117	T8490TBK	9
P9724	97	RCUWLCT	62, 69	STK1006	65	T8490TBL	9
P9725	97	RL125 80 1847	31	STK1006GRL	65	TC7501	75
P9770	99	RL125 80 1848	31	STK1006RDL	65	TC7502	75
P9776CL	102	RL125 80 1849	31	STK1006YLL	65	TC7503	75
P9777CL	102	RL125 80 1850	31	STK1008	65	TC121812	75
P9800	96	RL125 80 1851	31	SW12	64	TC121812GV	75
P9810	96	RL125 80 1852	31	SW18	64	TC152012	75
P9825	97	RL125 80 1853	31	SW1218	64	TC152012GV	75
PB17	103	RL125 80 1854	31	SW1218SC	64	TC182412	75
PB20-6	103	RL125 80 1855	31	SWX100	64	TC182412GV	75
PB20-12	103	RL125 80 1856	31	T		TC481201	76
PB25	103	RL125 80 1857	31	T12	116	TC4812012	76
PBS301-L	126	RL125 80 1858	31	T400TBK	12	TC4812014	76
PBS301-M	126	RL125 80 1859	31	T400TBL	12	TC4812034	76
PBS301-S	126	RP15	91	T410TBL	12	TPB20-MRN	103
PBS301-XL	126	RP18	91	T450TBK	12	TS510TBK	25
PBS301-XS	126	RW107 80 1226	29	T450TBL	12	TS510TBL	25
PL0103	87	RW107 80 1227	29	T451XC	12	TST9341	64
PL0105	87	RW107 80 1228	29	T800WH	13	TST9343	64
PL0403	87	RW107 80 1230	29	T850TBK	13	TST9345	64
PL0405	87	RW107 80 1231	29	T850TBL	13	U	
Q		RW107 80 1232	29	T950TBK	13	UCMX13BK	110
QSWLCT	69, 77	RW107 80 1233	29	T950TBL	13	UCMX15BK	110
R		RW107 80 1234	29	T990TBK	13	UCMX17BK	110
R200XC	19	RW107 80 1235	29	T990TBL	13	UHP55BK	120
R260XC	19	S		T1100TBK	13	UHP77BK	120
R1200XC	19	S30TBK	24	T1100TBL	13	UHP1010BK	120
R1500WH	18	S30TBL	24	T1100WH	13	UL5103	87
R1500XC	18	S890TBK	23, 24	T1190TBK	13	UL5104	87
R2000TBK	21	S890TBL	23, 24	T1190TBL	13	UL5105	87
R2000TBL	21	S900TBK	23	T1300TBK	10	UL5403	87
R2090TBK	21	S900TBL	23	T1300TBL	10	UL5405	87
R2090TBL	21	S1300TBK	23	T1390TBK	10	UPM15BK	110
R3000TBK	20	S1300TBL	23	T1390TBL	10	UPM17BK	110
R3000TBL	20	SERVSFAFEBOOK	69	T1400TBK	10	V	
R3090TBK	20	SF30TBK	24	T1400TBKHW	10	VM5180BK	87
R3090TBL	20	SF30TBL	24	T1400TBL	10	VM5280BK	87
R3500TBK	18	SF900TBK	23	T1400WH	10	VM5280BK-12	87
R3500TBL	18	SF900TBL	23	T1490TBK	10	VM5280CL	87
R3590TBK	18	SF1300TBK	23	T1490TBL	10	VM5280CL-12	87
R3590TBL	18	SF1300TBL	23	T1700TBK	14	VM5280RD	87
R3600TBK	17	SFC1200CL	69	T1700TBL	14	VM5280RD-12	87
R3600TBL	17	SFC1200QT	69	T1720TBK	15	VM5280WN	87
R3690TBK	17	SFC1250CL	69	T1720TBL	15	VM5280WN-12	87
R3690TBL	17	SFC1250QT	69	T1730TBK	24	W	
R3800TBK	18	SFCROLLCL	69	T1750TBK	14	WD1005	27
R3800TBL	18	SFCROLLQT	69	T1750TBL	14	WF107 80 1204	29
R4000TBK	20	SG10-L	125	T1750WH	14	WF107 80 1206	29
R4000TBL	20	SG10-M	125	T1755TBK	14	WP107 80 1202	29
R4090TBK	20	SG10-S	125	T1755TBL	14	WP107 80 1203	29
R4090TBL	20	SG10-XL	125	T1759TBK	14	WP1202MB	29
R6000TBK	21	SH900TBK	23	T1759TBL	14	WP1202TW	29
R6000TBL	21	SH900TBL	23	T1790TBK	14	WS107 80 1207	29
R6500TBK	21	Shake Collars	99	T1790TBL	14	WS107 80 1208	29
R6500TBL	21	SHF900TBK	23	T1800WH	15	WW1000	28
R93517	130	SHF900TBL	23	T1800XC	15	WW1001	28
RC110 80 1865	31	SI2000	59	T1905WH	15	WW1002	28
RC110 80 1866	31	SI2000BK	59	T1905XC	15	WWS1005	27
RC110 80 1867	31	SI4550	58	T7000TBK	11	X	
RC110 80 1868	31	SI5000	59	T7000TBL	11	X101924	44
RC110 80 1869	31	SI5500	59	T7090TBK	11	X101987	44
RC110 80 1870	31	SI6000	57	T7090TBL	11	XC2022	46
RC110 80 1871	31	SI6100	57	T7100TBK	11	XC2226	46
RC110 80 1872	31	SI6500	58	T7100TBL	11	XC2226BK	46
RC110 80 1874	31	SI7000	59	T7500TBK	11	XC2426	46
RCU64	62	SI7000BG	85	T7500TBL	11	XC2426BK	46
RCU64V2	61	SI7500	59	T7590TBK	11	XC2426	46
RCU64V2RD	61	SI7700	59	T7590TBL	11	XC2426BK	46
RCU128	62	SI7750	59	T8000TBK	10	XC2526	46
RCU128V2	61	SI8500	58	T8000TBL	10		
RCU128V2RD	61	SI9000	59	T8000WH	10		
RCU256	62	SI9500	59	T8090TBK	10		
RCU642	62	SI9800	28	T8090TBL	10		
		SICART60	58	T8400TBK	9		

Limited Warranty – San Jamar warrants to the original purchaser of each new product of its manufacture for a period of one (1) year from the date of shipment, (or if shorter, the period of the product's normal useful life) that all parts shall be free from defects in material and workmanship under normal use and service.

The warranties defined herein shall not apply to any damage or defects created or arising from accident, misapplication, abuse, misuse, neglect, alteration, acts of God, vandalism, flood, fire or any other occurrences beyond the control of San Jamar.

Claims under the foregoing warranty will be honored only if San Jamar (i) has received the entire payment of the purchase price for the product with respect to which any such claim is made (ii) has received notification of the claim prior to the expiration of the one (1) year (or shorter) warranty period described above, and (iii) determines upon examination of the returned product that it is defective under the terms of such warranty.

San Jamar's sole obligation under the foregoing warranty and other claims related to any product shall be limited to, at San Jamar's option (i) repairing or (ii) replacing F.O.B. factory or any product which San Jamar determines is defective under the terms of such warranty.

THE FOREGOING WARRANTY AND REMEDIES ARE EXCLUSIVE AND IN LIEU OF ANY OTHER WARRANTIES AND REMEDIES WHATSOEVER, EXPRESSED OR IMPLIED, INCLUDING BUT NOT LIMITED TO ANY IMPLIED WARRANTIES OF MERCHANTABILITY OR FITNESS FOR PARTICULAR PURPOSE, ALL OF WHICH SAN JAMAR HEREBY EXPRESSLY DISCLAIMS.

Return Policy – Product returned to San Jamar must have a Returned Goods Authorization (RGA) number from the Customer Care department. It will be the customer's responsibility to cover freight charges, and a 15% Restocking Charge will be applicable to all returned product. To receive credit for returned goods, they must be returned within 90 days of purchase, in unopened cartons, labeled with the RGA number, and returned within 30 days of the RGA being issued. Credit will be determined upon receipt and inspection of product. Obsolete or phased out product is not eligible for return. Should you have any questions, please contact Customer Care at 800-248-9826 or orders@sanjamar.com.

sanjamar.com

San Jamar

555 Koopman Lane
Elkhorn, Wisconsin 53121
USA
T: +1.262.723.6133
F: +1.262.723.4204
info@sanjamar.com
www.sanjamar.com

Canada

15252 32nd Avenue
Suite 309
Surrey, BC V3S 0R7
CANADA
T: +1.262.723.6133
F: +1.262.723.4204
canada@sanjamar.com

Europe

Schoorstraat 26a, bus 1
2220 Heist op-den Berg
BELGIUM
T: +32 1522 8140
F: +32 1522 8148
emea@sanjamar.com

México

Av. Universidad #1377-701
Colonia Axotla CP 01030
Del. Alvaro Obregón
MEXICO, D.F.
T: +52 (55) 3626 0772
F: +52 (55) 5273 4495
mexico@sanjamar.com

