

CARLISLE[®]

FOODSERVICE PRODUCTS



Carlisle Works Hard To Make Your Work Easier

Front of House

Carlisle is the leader in durable, attractive plastic tabletop ware and table coverings. From classic to festive settings, Carlisle has everything you need for interior, patio, and bar service—besides the furniture and food. We also have a wide range of display and serving ware for buffet, cafeteria, and banquet dining including portable food and beverage bars. Our attractive, durable tabletop and serving ware will save you up to 30% per year in breakage versus china and glassware.

Back Of House

Carlisle knows how challenging it can be to run a foodservice operation—consistently serving great, fresh food that is cost effectively prepared with stringent food safety practices. You can turn to Carlisle for professional food prep, storage, handling, and transport needs designed for the exacting requirement of foodservice professionals. Our wide assortment of top quality food prep tools, food pans, storage and handling supplies, and transport equipment make it easier for you to operate your business.

Food Safety & Cleaning Tools

Only Carlisle can provide you a full line of food prep & handling supplies along with cleaning tools and waste handling. We design our products to NSF food safety standards that fit into your ServeSafe® operating practices. Our Carlisle StorPlus™, Sparta® Brush, and Bronco™ brands are crafted to not only help you reduce the risk of foodborne illness outbreaks, they also help you prepare great food in the most cost effective manner. Turn to Carlisle for industry leadership in essential food preparation and cleaning tool solutions.

YOU CAN COUNT ON CARLISLE AS A TRUSTED RESOURCE FOR CRITICAL SUPPLIES ACROSS YOUR ENTIRE SITE. FROM THE BACK OF HOUSE TO THE FRONT, CARLISLE HELPS YOU DELIGHT YOUR GUESTS AND RUN A CLEAN, SAFE AND EFFICIENT FOODSERVICE OPERATION.



We're proud to be the trusted resource for your critical front of house, back of house, food safety, and cleaning tool supplies. Turn to the Carlisle catalog to help make your work easier.

CATALOG GUIDE

	Dinnerware.....	6-33
	Drinkware.....	34-55
	Tabletop Accessories	56-69
	Marko.....	70-75
	Displayware	76-105
	Food Bars & Convenience.....	106-131
	Bar Supplies.....	132-147
	Foodservice Trays.....	148-163
	Catering Equipment	164-177
	Professional Cookware	178-189
	Kitchen Accessories	190-211
	Storage & Handling	212-231
	Warewashing	232-249
	Cleaning Tools.....	250-271
	Floor & Restroom Care.....	272-307
	Transportation	308-317
	Waste Management	318-329
	Reference/Index/ Terms & Conditions	330-344

Section Identification

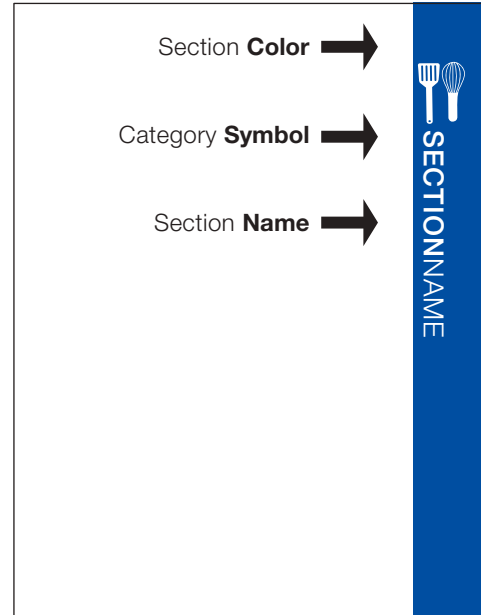

Category Symbols

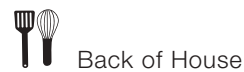

product listings on next page »

PRODUCT	PAGE	PRODUCT	PAGE	PRODUCT	PAGE
21 Key Brushes	252-255	Double Wall Stainless Steel	97	Equipment	258-262, 264-265
Adapter Bars	222	Epicure Acacia Wood Grain	84	Ergonomic Hand Scrubs	269
Bains Maries	229	Epicure Cased	30	General Clean Up	268-269
Bakeware		Epicure Displayware	25, 84	Glass Washing	257
Bake Pans	186	Flared Square	79	Grill Bricks	265
Cupcake Pans	187	Gathering	12	Hand & Nail	266
Icing Grates	189	Grove	9	Handle Guide	271
Muffin Pans	187-188	Halcyon	10-11	High Temp	258
Pie Pans	188	Leaf	95	Hot Dog Roller	258
Pullman Pans	187	Melamine Bowls	27	Iron Handle	261
Loaf Pans	187	Microwave-Ware	31	Oven & Grill	264
Roast Pans	186	Mingle	8	Pastry	198-200
Sheet Pans	189	Mixing	206	Potato	201
Bar Accessories	139-147	Octagon	91	Racks	292
Bar Caddy	140	Orchid Deli	90	Radiator	271
Bar Mat & Service Mat	141	Palette Designer Displayware	82	Scratch	265
Bar & Shelf Liner	141	Palette Displayware Covers	83	Spouts, Pumps & Valves	259
Barware		Parasol	13	Tile & Grout	285
Alibi	36-37	Pebbled	96, 103	Toilet Bowl Brush	305
Astaire	39	Petal Mist	28, 94	Toothbrush Style	262
Epicure Cased	38	Punch	103	Utility Scrubs	260
Lexington Mug	49	Rave Displayware	80	Vegetable	201
Liberty	45	Roll-Top Covered	68	Vegetable Cutter	261
Baskets		Salad	27, 30, 85	Wok	260
Basket Server	64	Salsa	60-61	Bud Vases	63
Bread & Bun Basket	65	Scoop	89	Burger Cover	184
Munchie Baskets	64	Soup	31	Bus Boxes & Lids	249
WeaveWear Baskets & Platter	65	Square Display	98	Caddies, Condiment & Bar	137-138
Wicker Look Basket	65	Stacking	95	Cake Covers & Tray	99
Woven Baskets	64	Terra Deliware	85	Cake & Display Stands	105, 125
Basting Brushes	198-200	Brooms		Carts	
Beverage Dispensers/Servers		Angle	274	Bussing/Transport	311
Cateraide IT	168	Duo-Sweep	274-275	Dish Dollies	314-315
Cateraide LD Series Insulated	173	Dust Pans	282	Fold 'N Go Carts	310
Cateraide Slide 'N Seal Insulated	170	Floor Sweepers	282	Janitorial Carts	316-317
Cateraide XT Series Insulated	172	Handle Guide	306-307	Service Carts	312
Round Beverage Dispenser	131	Lobby Pans	281-282	Stainless Steel Carts	312
Square Beverage Dispenser	131	Lobby Pans & Broom Combos	281	Utility Carts	312-313
TrimLine Rectangular	130-131	Natural Corn & Blend	276	Carafes	
Bins, Ingredient	231	Racks	292	2 Cup	48
Booster Seats	69	Recycled	274	Cascata	48
Bottle, Oil and Sprayer	211	Straight	275	Charger Plates	29
Bottle Brushes	257	Synthetic Corn	277	Chili & Soup Servers	174
Bottle Holders	138, 146	Brushes & Scrubs		Cocktail Shakers	144
Bottle Pourers	136-137	Atlas Multi-Purpose	256	Coffee Mugs	49
Bowls		Bake Pan Lip	261	Coffee Service	
Allegro Display	96	Basting	198-200	Cheese Shaker/Sugar Pourer	62
Balsam Display	76	Bottle & Jar	257	Creamer/Pitchers	62
Balti	96	Butcher Block	262	Drip Trays, NeWave	105
Bell	93	Coffee Service	259	Sugar Caddies	62
Clam Shells	93	Counter Top	271	Colanders & Strainers	184, 206
Coldmaster Coldbowl	115	Cutting Board	256	Coldmaster Products	
Designer Displayware	88	Dish	263	CaterCooler	174

PRODUCT	PAGE	PRODUCT	PAGE	PRODUCT	PAGE
Coldmaster Chillers	110	Dessert Dishes	27	Mirrored Trays	104
Coldmaster Coldbowl	115	Dinnerware		Modular Displayware	92
Coldmaster Coldcrook & Accessories	114	Commercial, Polycarbonate	26	Narrow Rimmed	84
Coldmaster Coldpans	113	Dallas Ware	18-19	Octagon Bowls	91
Coldmaster Condiment Bar		Dayton	22-23	Octagonal Crocks	91
Organizers	115	Durus	14-15	Orchid Deli Bowls	90
Coldmaster CoolCheck	108-109	Epicure	25	Palette Designer Displayware	82
Coldmaster Dispenser	115	Gathering	12	Pebbled Bowls	96
Coldmaster EZ Access Lids	112	Grove	9	Petal Mist	94
Coldmaster Ice Cream Server		Halcyon	10-11	Plate Stands	89
& Lid	27, 114	Kingline	20-21	Rave Displayware	80
Coldmaster Standard Food Pans		Mingle	8	Rectangular Crocks & Platter	93
& Lids	111	Parasol	13	Risers	99
Condiment Bars & Accessories	115, 117	Sierrus	16-17	Salad Bowl	85
Condiment Caddies	139-140	Square	24	Scalloped Platters	81
Condiment Organizers	126, 129, 139-140	Terra	24	Scalloped DeliWare & Inset	85
Condiment Pumps	114, 117, 126	Dish Dollies, Optimizer	314-315	Scoop Bowl	89
Containers		Dish Racks		Square Display Dishes	98
Bains Mariés	229	All-Purpose Plate & Tray Rack	243	Stacking Bowls	95
Crocks	116-117	Combination/Flatware Rack	242	Stands	105
Food Boxes	224-225	Cup Racks	243	Terra Deliware	87
Food Pans	98, 111, 113	Dollies	245	Terra Displayware	81
Rounds	228	Dust Cover	245	Tulip Deli Crocks	90
Squares	226-227	Food Pan Rack	243	Disposable Lids	54-55
Cookware		Open/Bowl Racks	242	Double Boiler	184
Braziers	182	Peg Racks	242	Drain Grates	230
Covers	184-185	Plaque-A-Rack System	246-247	Dredges/Powder Cans	207
Double Boiler	184	Rack Cover	245	Drinkware	36-47, 49
Fry Pans	180-181	Dishers	203	Drip Trays	105
Mesh Baskets	184	Dishes, Roll-Top	68	Dust Pans & Lobby Brushes	281-282
Sauce Pans	183	Dispensers		Dusters	270
Sauté Pans	183	Counter Top Lid & Straw Dispenser	129	End Loaders	
Sectional	183	Cup Dispensers	128	Cateraide IT	169
Stock Pots	182	Straw Dispenser	129	Cateraide Slide 'N Seal	171
Covers		Toothpick Dispenser	129	CaterCooler	174
Burger	184	Display Cases, Pastry	125	Dollies	176
Cake	99	Display Cubes	104	Insulated	175
Compartment Tray	158	Display Stands	105	Floor Brushes	
Cookware	184-185	Displayware		Dual Surface Brushes	283
Custom, Plate	33	Allegro Display Bowls	98	Handle Guide	306-307
Display	99	Balsam	78	Handles	289-291
Palette Displayware	83	Balti Dishes	98	Racks	292
Pastry Tray	158	Bell Bowls	95	Scrubs	283-284
Plate	32	Clam Shells	95	Swivel Floor Brushes	284
Crocks		Designer Displayware	88	Tile & Grout Brushes	285
Classic Crook Condiment Station	117	Double-Wall Stainless Steel		Floor Maintenance	
Classic Crocks	117	Displayware	97	Boot 'N Shoe Brush	305
Gourmet Crocks	118	Epicure Acacia Wood Grain	86	Caution Cones	303
Poly-Tuf Crocks	117	Epicure Displayware	25, 84	Floor Drain Brush	304
Supreme Crocks	118	Flared Square Bowls	79	Floor Drain Opener	304
Tulip Deli Crocks	90	Leaf Bowls	95	Floor Sweepers	282
Cup Dispensers	128	MirAcryl Cubes	104	Wet Floor Signs	303
Cutting Boards & Accessories	192-193				

continued on next page »

PRODUCT	PAGE	PRODUCT	PAGE	PRODUCT	PAGE
Floor Rack System	231	Grill Bricks, Screens	265	Oven/Broiler Brushes, Scrapers	264-265
Floor Squeegees		Hand & Nail Brushes	266	Packet Racks	126
Double Foam Squeegees	286-287	Handles & Accessories	274-275, 289-292, 300-302	Paddle Scrapers	208
Handle Guide	306-307	Handle Guide	306-307	Pails, Cleaning, Disinfecting	267
Handles	289-291	Heat Lamps	194-195	Pan Carriers	169, 171, 175
Racks	292	Ice Buckets & Caddies	146-147, 177	Pans, Baking	
Rubber Squeegees	287-288	Ice Caddies, Cateraide	177	Bake Pans	186
VersaClean Brush & Squeegees	288	Ice Cream Server & Lid, Coldmaster	27, 114	Cupcake Pans	187
Floor Sweeps		Ice Only Container	197	Icing Grates	189
All Purpose Omni Sweep	278	Ice Scoops	147, 197	Muffin Pans	187-188
Fine Floor Sweeps	279	Ice Sculptures	102	Pie Pans	188
Handle Guide	306-307	Ice Totes, Containers	177, 197	Pullman Pans	187
Handles	289-291	Icing Grates	189	Loaf Pans	187
Heavy Floor Sweeps	280	Insulated Food		Roast Pans	186
Medium Floor Sweeps	279	Pan Carriers	169, 171, 175	Sheet Pans	189
Multi-Surface Floor Sweeper	282	J-Jars	61	Pasta Cookers, Sectional	183
Racks	292	Janitorial Carts & Accessories	316-317	Pasta Forks	118-119
Sweep Complete	278	Ladles	100, 119	Pastry Brushes	198-200
Food Bars		Lid & Condiment Organizer	129	Pastry Display Cases	123
Adapter Bars	222	Liquor Pourers	142-143	Pastry Tray Covers	158
Buffet Bars	125	Lobby Pans	281-282	Pitchers	50-53, 62
Five-Star	125	Measurers		Plate Covers	
Maximizer	120-121	Commercial	202	Custom Plate Covers	33
Six-Star	122-123	Dishers	203	Polycarbonate Plate Covers	32
Sneeze Guards	125	Measure Misers	203-205	Polyglass Plate Covers	32
Tabletop	122-124	Measuring Cups	202	Plate Stands	89
Youth	122-123	One Gallon Containers	201	Plates	
Food Boxes & Containers		Portioning Cups	201	Charger	29
Bains Maries	229	Microfiber Cloths	267	Epicure Acacia Wood Grain	86
Color-Coded	224-225	Microwave Ware	31	Leaf	28
Economical Space Saver	227	Mixing Bowls	206	Petal Mist	28, 94
Food Storage Boxes & Lids	224-225	Money Maid Combo Packs	159	Terra Delware	87
Round Containers & Lids	228	Mop Buckets	303	Portable Bar & Accessories	134-135
Square Containers & Lids	226-227	Mops & Accessories		Powder Cans & Dredges	207
Food Pans		Cut-End Mops	298-300	Pump Kit	124
Coldmaster Food Pans	108, 110-111, 113	Dust Mops	294	Punch Bowls	103
Drain Grates	218-221	Looped-End Mops	297-298	Ramekins	
Drain Shelves	218, 220-221	Microfiber Mops	293	Butter Dish	59
DuraPan Food Pans & Accessories	222-223	Microfiber Bucket	294	Japanese Style	59
EZ Access Lids	219-220	Mop Bucket & Wringer Combos	303	Melamine	60
High Heat Pans	216-217, 220-221	Mop Guide	295-296	Molcajete	60
Palette Designer Displayware Pans	83	Mop Handles	300-302	Oval	58
Polycarbonate Pans	216-219	Screw Top Mops	300	Salsa Dishes	60
Smart Lids	216	Sponge Mops	301	SAN	61
Specialty Food Pans	221	Muffin Pans	187-188	Sauce Cups	61
Universal Food Pan Lids	216	Mugs		Scalloped	59
Food Preparation Brushes	201	Coffee	49	Square	58
French Whips	210	Lexington	49	Stainless Steel	61
Fry Pans	180-181	Number Stands	67	Straight Sided	58
Fryer Baskets	184	Order Racks	196	Rectangular Microfiber Bucket	294
Glass Rimmers	142	Order Wheels	196	Recycle Containers & Lids	326-327
				Recycle Lable Kit	327

PRODUCT	PAGE	PRODUCT	PAGE	PRODUCT	PAGE
Restroom Maintenance		Tilt Trucks	328-329	Tumblers	
Bowl Brushes	305	Tip Trays	159	Bistro	43
Force Cup	305	Tongs	100-101, 118, 210	Crystalon RimGlow	46
Risers	99	Tool Caddy	317	Crystalon Stack-All	43
Salad Bars	120-124	Toothpick Dispenser	129	Genuine Coca-Cola	41, 44
Salsa Dishes & Bowls	58-59	Top Loaders		Lafayette	47
Sauce Cups	59	Cateraide IT	169	Lorraine	42
Scoops	147, 197	Cateraide Slide 'N Seal	171	Louis	42
Scrapers	208-209, 270	CaterCooler	174	Pebble Optic	44
Scrubs, Sponges	263	Dollies	176	Pepsi	41
Server, Tortilla	66-67	Insulated	175	Stackable	40-41, 46
Servers, Tiered	105	Topping Rails	127	Swirl	47
Service Mat & Bar Mat	141	Tortilla Servers	66-67	Turners	211
Serving Spoons, Buffet Spoons & Pasta Forks	100, 118-119	Tote Boxes & Lids	248	Vases, Bud	63
Servingware	100-101	Trays		Warewashing Racks & Accessories	
Shaker/Dredge	62, 207	Bakery	152-153	Color-Coded	236-241
Shakers, Cocktail	144	Bar	160-161	Dish	242-243
Sheet Pan Carriers	175	Bistro	155	Dollies	245
Shelf Liner & Bar Mat	141	Café	155	Dust Cover	245
Shovels	211	Cake	99	Flatware	244
Skimmers, Wire Mesh	207	Carrier, Insulated	175	Glass	236-241
Sneeze Guards	125	Celebration, Chrome Plated	162	Hold Down Grid	244
Soup & Chili Servers	174	Compartment	156-158	NeWave	237
Soup Service	31	Cork	161	OptiClean Rack System	234-235
Spatulas	208-209	Covers	158	Placque-A-Rack System	246-247
Specialty Racks	242-244	Display	152-153	Rack Cover	245
Speed-Rak Bottle Holders	138	Drip	105	Specialty	242-244
Sponges, Scour Pads	263	Festival	163	Waste Containers	
Spoons	100, 118-119	Fiberglass	150-154	50-Gallon Roll Away	323
Spouts	136-137, 142-143	Glasteel	150-153	Bronco & Lids	321-323
Spouts, Pumps & Valves	112-113, 115, 124-125	GripLite	161	Centurian	324
Squeegees		Griptite 2	160	Compost	327
Floor	285-288	Handled	155	Dollies	320-323
Window	270	Illuminated	102	Fire Resistant	325
Stands, Number	69	Low Edge	152-153	Hot Stamped	322
Step Risers	99	Market	154	Office Wastebaskets	325
Steri- & Suds-Pails	267	Metric	152-153	Recycle Containers & Accessories	326-327
Store 'N Pour		MirAcryl Display	104	Square Bronco	323
PourPlus	136	Octagonal	162	Tool Caddy Bag	322
Complete Units & Backups	137	Oval	106-162	TrimLine	320
Condiment System	140	Petal Mist	94	Wet Floor Sign	303
Speed Spout	137	Polycarbonate	154	Whips, French	210
Bar Service Pack	137	Racks	243	Window Maintenance	
Strainers & Colanders	184, 206	Rectangular	152-153, 160, 162-163	Squeegees	270
Straw Dispenser	129	Room Service	159	Scrapers	270
Sugar Caddies	62	Round	68, 160-163	Wine Buckets & Stands	145
Sugar Pourer/Cheese Shaker	62	Stands	163	Wine Holder	146
Suds-Pails	267	Tip	159	Wine Servers & Coolers	144-146
Syrup Pitchers	62	Trapezoid	152-153, 155	Wire Mesh Baskets	184
Ticket Wheels	196	Wrap Trays	152	Wire Mesh Skimmers	207
		Tulip Dishes	21		



CARLISLE
FOODSERVICE PRODUCTS

ELEGANT VERSATILE DURABLE BEAUTIFUL **DINNERWARE**

Carlisle offers a wide array of guest pleasing dinnerware choices that can coordinate with every type of venue and cuisine. Set your table with Carlisle and watch the savings stack up vs. traditional porcelain dinnerware. Our durable collections are designed to be beautiful and long-lasting.



MELAMINE DINNERWARE

Mingle's swirl design draws attention to the center of the plate – **putting the focus on your culinary creations.**

Mingle

- Perfect for employee dining, pool & resort dining or any casual venue where durability is ideal
- Textured body and swirl design puts the focus on your culinary creations
- Base color mimics ceramics
- Safe up to 212°F
- NSF Listed; dishwasher safe
- Two-year limited warranty



The Carlisle
TABLETOP
COLLECTION



Prod No	Description	Color	Pack
Mingle Dinnerware			
54001 Δ	11" Dinner Plate	13, 15, 17, 18, 46, 52	12 ea
54002 Δ	9" Salad Plate	13, 15, 17, 18, 46, 52	12 ea
54003 Δ	9", 28.5 oz Rimmed Soup	13, 15, 17, 18, 46, 52	6 ea
54004 Δ	7", 27 oz Ice Cream Bowl	13, 15, 17, 18, 46, 52	12 ea
54005 Δ	6", 17 oz Bowl	13, 15, 17, 18, 46, 52	12 ea
54006 Δ	15.5" Charger Plate	13, 15, 17, 18, 46, 52	12 ea
54007 Δ	7" Bread & Butter Plate	13, 15, 17, 18, 46, 52	12 ea
54018 Δ	5", 4.5 oz Fruit Bowl	13, 15, 17, 18, 46, 52	48 ea
54019 Δ	8", 35.5 oz Cereal Bowl	13, 15, 17, 18, 46, 52	12 ea

NSF Listed products are designated with a Δ and may be prefixed with an N
Note: Melamine Dinnerware is not recommended for microwave

Grove offers a **linear look for perfect plating**. Classic shapes offer unlimited options.

Grove

- Designed to work for employee dining, pool & resort, casual dining, buffet service
- Base color mimics ceramic
- NSF Listed; dishwasher safe
- Two-year limited warranty



The Carlisle
TABLETOP
 COLLECTION



Prod No	Description	Color	Pack
Grove Dinnerware			
64001 Δ	11" Dinner Plate	06, 15, 18, 46, 70	12 ea
64002 Δ	9" Salad Plate	06, 15, 18, 46, 70	12 ea
64004 Δ	12.5" Charger	06, 15, 18, 46, 70	12 ea
64007 Δ	7" Bread & Butter Plate	06, 15, 18, 46, 70	12 ea
64020 Δ	12" x 8" Oval Plate	06, 15, 18, 46, 70	12 ea
64022 Δ	10.5" x 10.5" Square Dinner Plate	06, 15, 18, 46, 70	12 ea
64023 Δ	8.5" x 8.5" Square Salad Plate	06, 15, 18, 46, 70	12 ea
64003 Δ	9", 28.5 oz Soup Bowl	06, 15, 18, 46, 70	6 ea
64005 Δ	6", 17 oz Small Bowl	06, 15, 18, 46, 70	12 ea
64013 Δ	7", 27 oz Ice Cream Bowl	06, 15, 18, 46, 70	12 ea
64017 Δ	12", 5.2 qt Large Bowl	06, 15, 18, 46, 70	6 ea
64018 Δ	5", 4.5 oz Fruit Bowl	06, 15, 18, 46, 70	48 ea
64009 Δ	9" Square Tray	06, 15, 18, 46, 70	6 ea
64015 Δ	15" x 9" Tray	06, 15, 18, 46, 70	6 ea
64021 Δ	20" x 14" Oval Tray	06, 15, 18, 46, 70	4 ea

NSF Listed products are designated with a Δ and may be prefixed with an N
 Note: Melamine Dinnerware is not recommended for microwave

MELAMINE DINNERWARE

Dinnerware that provides **artful plating** choices for dishes ranging from sushi and salads to pasta and fries.

Halcyon

- Unique design enhances the appearance of plated foods
- Made of durable, heavy-weight melamine
- Resistant to staining, breaking and chipping
- Safe for temperatures up to 212°F
- NSF Listed; dishwasher safe
- Two-year limited warranty



The Carlisle
TABLETOP
COLLECTION



White(02)

Prod No	Description	Color	Pack
Halcyon Dinnerware			
HAL01 Δ	5", 12 oz Flared Rim Appetizer Cup	02	12 ea
HAL02 Δ	5.5", 18 oz Flared Rim Appetizer Cup	02	12 ea
HAL03 Δ	10", 16 oz Oval Pasta Bowl	02	12 ea
HAL04 Δ	12", 6 oz Round Pasta Bowl	02	12 ea
HAL05 Δ	5", 11 oz Angled Appetizer Cup	02	12 ea
HAL06 Δ	6", 16 oz Angled Appetizer Cup	02	12 ea
HAL09 Δ	9" Square Rim Plate	02	12 ea
HAL10 Δ	10-1/2" Square Rim Plate	02	12 ea
HAL11 Δ	12" Square Rim Plate	02	12 ea
HAL12 Δ	3 Compartment Tray	02	6 ea
HAL13 Δ	7.62 x 7" x 3", 3 oz Small Lily Bowl	02	12 ea
HAL14 Δ	10.5" x 9" x 4.25", 8 oz Medium Lily Bowl	02	12 ea
HAL15 Δ	11.5" x 9.5" x 4.5", 10 oz Large Lily Bowl	02	12 ea
HAL16 Δ	10" Serving Platter	02	12 ea
HAL17 Δ	11.5" Serving Platter	02	12 ea

NSF Listed products are designated with a Δ and may be prefixed with an N
Note: Melamine Dinnerware is not recommended for microwave



The Carlisle
TABLETOP
COLLECTION

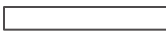

White(02)

Prod No	Description	Color	Pack
Halcyon Dinnerware			
HAL18 Δ	13" Serving Platter	02	6 ea
HAL20 Δ	4", 20 oz Petite Sauce Bowl	02	24 ea
HAL21 Δ	4.5", 2 oz Handled Sauce Bowl	02	24 ea
HAL22 Δ	11", 8 oz Top Hat Pasta Bowl	02	12 ea
HAL23 Δ	12", 5 oz Oval Low Bowl	02	12 ea
HAL24 Δ	10.5" x 6.5" Small Serving Plate	02	12 ea
HAL26 Δ	13" x 6.5" Sleigh Tray	02	12 ea
HAL27 Δ	.25 oz Pho Spoon	02	48 ea
HAL28 Δ	.25 oz Broth Spoon	02	48 ea
HAL31 Δ	2.5", 1 oz Spoon Bowl	02	48 ea
HAL32 Δ	3.5", 2 oz Handled Bowl	02	48 ea

NSF Listed products are designated with a Δ and may be prefixed with an N
Note: Melamine Dinnerware is not recommended for microwave

MELAMINE DINNERWARE

Gathering offers you the **rustic charm of hand thrown pottery** with the durability of melamine.

Gathering

- For use where breakage is a concern
- Heavy-weight melamine is break-resistant
- The look and feel of hand thrown pottery brings a farm to table look to your presentation
- Base color mimics ceramic
- NSF Listed; dishwasher safe
- Two-year limited warranty



The Carlisle
TABLETOP
COLLECTION



Prod No	Description	Color	Pack
Gathering Dinnerware			
GA55001 Δ	11" Dinner Plate	70	12 ea
GA55002 Δ	9" Salad Plate	70	12 ea
GA55003 Δ	8", 35.5 oz Small Bowl	70	12 ea
GA55005 Δ	14.74", 5.2 qt Serving Bowl	70	6 ea
GA55006 Δ	18" Round Platter	70	4 ea
GA55007 Δ	7.5", 9.5" and 10.5" (set of 3 Bowls)	70	2 sets
GA55008 Δ	7" Bread & Butter Plate	70	12 ea
GA55009 Δ	12.5" Square Plate	70	6 ea
GA55010 Δ	15.5" x 11" Rectangular Tray	70	12 ea
GA55011 Δ	6", 20 oz Small Bowl	70	12 ea
GA55012 Δ	4.62", 9 oz Dip Bowl	70	12 ea
GA55013 Δ	12.5" Charger Plate	70	12 ea
GA55014 Δ	12" x 8" Oval Platter	70	12 ea

NSF Listed products are designated with a Δ and may be prefixed with an N

Note: Melamine Dinnerware is not recommended for microwave

Ideal choice for indoor or outdoor settings in need of a fun refresh.

Parasol

- Enhance indoor or outdoor dining with a fun, fresh design
- Durable, heavy-weight melamine
- Textured surface maintains good looks longer and enhances the appearance of plated foods
- Safe for temperatures up to 212°F
- Two-year limited warranty
- Dishwasher safe and stain resistant

The Carlisle
TABLETOP
COLLECTION



Multi(00)

Prod No	Description	Color	Pack
Parasol Dinnerware			
PAR19	9" Salad Plate	00	12 ea
PAR20	11" Dinner Plate	00	12 ea
PAR22	18" Platter	00	4 ea
PAR23	6", 27 oz Bowl	00	12 ea
PAR24	6.5", 35 oz Bowl	00	12 ea

Note: Melamine Dinnerware is not recommended for microwave

MELAMINE DINNERWARE

Durus looks and feels like porcelain dinnerware without the replacement costs due to chipping or breaking. **Switch to Durus and watch the savings pile up!**

Durus®

- High quality, heavy-weight melamine dinnerware has the look and feel of china without the replacement cost
- Available in 9 solid colors
- Minimize your scratch and stain problems with our exclusive mirror-like glaze
- See a return on investment in less than 18 months in most operations after switching to Durus from china
- Reduce dinnerware drying time with the advanced Durus foot design and slick water-sheeting glazed surface
- Save money with our Durus four-year warranty* against breakage, the best guarantee in the industry
- Mix and match Durus side dishes with china plates for a beautiful tabletop that costs less to maintain
- Custom decorating available; contact Customer Service at 1-800-654-8210 for custom imprinting information
- Safe for temperatures up to 212°F
- Four-year limited warranty
- NSF Listed; dishwasher safe



Coordinating Tumblers, Ramekins & Soup Bowls are also shown below
Additional information on coordinating pieces can be found in the Drinkware & Tabletop Accessories catalog sections



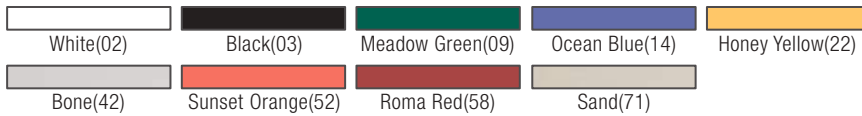

Prod No	Description	Color	Pack
Durus Narrow Rim Plates			
43000 Δ	10.5" 3-Compartment Plate	42	12 ea
43002 Δ	10.5" Dinner Plate	02, 09, 14, 22, 42, 52	12 ea
43004 Δ	9" Dinner Plate	02, 09, 14, 22, 42, 52, 58, 71	24 ea
43006 Δ	7.25" Salad Plate	02, 09, 14, 22, 42, 52	48 ea
43008 Δ	6.5" Pie Plate	02, 03, 09, 14, 22, 42, 52, 71	48 ea
Durus Wide Rim Plates			
43024 Δ	12" Dinner Plate	02	12 ea
43010 Δ	10.5" Dinner Plate	02, 14, 22, 42, 52	12 ea
43012 Δ	9" Dinner Plate	02, 09, 14, 22, 42, 52	24 ea
43016 Δ	7.5" Salad Plate	02	48 ea
43018 Δ	6.5" Pie Plate	02, 14, 42	48 ea
Durus Oval Platters			
43080 Δ	13.5" x 10.5" Oval Platter	02, 09, 14, 22, 42, 52, 71	12 ea
43082 Δ	12" x 9.25" Oval Platter	02, 03, 09, 14, 22, 42, 52, 58, 71	12 ea
43086 Δ	9.5" x 7.25" Oval Platter	02, 03, 22, 42, 52	24 ea
Durus Bowls & Cup			
43030 Δ	20 oz, 12" Chef Salad/Pasta Bowl	02, 03, 09, 14, 22, 42, 52, 58	12 ea
43032 Δ	16 oz, 7.5" Rimmed Bowl	02, 03, 09, 14, 22, 52	24 ea
43034 Δ	13 oz, 9.25" Pasta/Soup/Salad Bowl	02, 09, 14, 22, 42, 52, 58	24 ea
43036 Δ	12 oz, 7.25" Rimmed Bowl	02, 09, 14, 22, 42, 52, 71	24 ea
43038 Δ	10 oz, 5.38" Rimmed Nappie Bowl	02, 09, 14, 22, 42, 52	24 ea
43040 Δ	6 oz, 6" Rimmed Bowl	02, 09, 14, 22, 42, 52	48 ea
43042 Δ	4.5 oz, 4.75" Rimmed Fruit Bowl	02, 09, 14, 22, 42, 52, 58, 71	48 ea
43050 Δ	7 oz, 4" Bouillon Cup	02, 03, 09, 14, 22, 42, 52, 71	48 ea

NSF Listed products are designated with a Δ and may be prefixed with an N
 Note: Melamine Dinnerware is not recommended for microwave

MELAMINE DINNERWARE

Dress your dining table with the **beauty and feel of porcelain** at a fraction of the price. Sierrus Dinnerware is a **medium weight** version of our popular Durus design. Mix and match Durus with Sierrus to make your budget go farther.

Sierrus™

- All purpose, medium-heavy weight dinnerware has the same design as our Durus® line
- Available in eight solid colors
- Made of heavy-duty, break-resistant melamine
- Safe for temperatures up to 212°F
- Two-year limited warranty
- NSF Listed; dishwasher safe

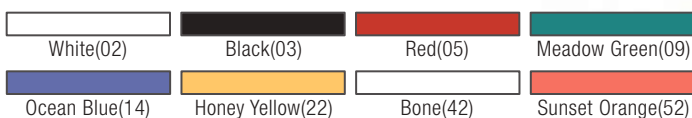

Prod No	Description	Color	Pack
Sierrus Narrow Rim Plates			
33000 Δ	10.5" 3-Compartment Plate	02, 03, 05, 09, 14, 22, 42, 52	12 ea
33002 Δ	10.5" Dinner Plate	02, 03, 05, 09, 14, 22, 42, 52	12 ea
33004 Δ	9" Dinner Plate	02, 03, 05, 09, 14, 22, 42, 52	24 ea
33006 Δ	7.25" Salad Plate	02, 03, 05, 09, 14, 22, 42, 52	48 ea
33008 Δ	6.5" Pie Plate	02, 03, 05, 09, 14, 22, 42, 52	48 ea
Sierrus Wide Rim Plates			
33024 Δ	12" Dinner Plate	02, 03, 05, 09, 14, 22, 42, 52	12 ea
33010 Δ	10.5" Dinner Plate	02, 05, 09, 14, 22, 42, 52	12 ea
33012 Δ	9" Dinner Plate	02, 03, 05, 09, 14, 22, 42, 52	24 ea
33016 Δ	7.5" Salad Plate	02, 05, 09, 14, 22, 42, 52	48 ea
33018 Δ	6.5" Pie Plate	02, 03, 05, 09, 14, 22, 42, 52	48 ea
33020 Δ	5.5" Bread & Butter Plate	02, 03, 05, 09, 14, 42, 52	48 ea

NSF Listed products are designated with a Δ and may be prefixed with an N
 Note: Melamine Dinnerware is not recommended for microwave



Carlisle Mugs

Our new Carlisle Mugs pair perfectly with the color options of Sierrus Dinnerware.

See page 49 for more information on these great mugs.

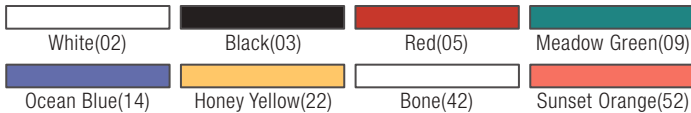

Prod No	Description	Color	Pack
---------	-------------	-------	------

Sierrus Platters

33080 Δ	13.5" x 10.5" Oval Platter	02, 03, 05, 09, 14, 22, 42, 52	12 ea
33082 Δ	12" x 9.25" Oval Platter	02, 03, 05, 09, 14, 22, 42, 52	12 ea
33086 Δ	9.5" x 7.25" Oval Platter	02, 03, 05, 09, 14, 22, 42, 52	24 ea

Sierrus Bowls & Cup

33030 Δ	20 oz, 12" Chef Salad/Pasta Bowl	02, 03, 05, 14, 22, 42, 52	12 ea
33032 Δ	16 oz, 7.5" Rimmed Bowl	02, 03, 05, 09, 14, 22, 42, 52	24 ea
33034 Δ	13 oz, 9.25" Pasta/Soup/Salad Bowl	02, 03, 05, 09, 14, 22, 42	24 ea
33036 Δ	12 oz, 7.25" Rimmed Bowl	02, 03, 05, 09, 14, 22, 42, 52	24 ea
33038 Δ	10 oz, 5.38" Rimmed Nappie Bowl	02, 03, 05, 09, 14, 22, 42, 52	24 ea
33040 Δ	6 oz, 6" Rimmed Bowl	02, 03, 05, 09, 14, 22, 42, 52	48 ea
33042 Δ	4.5 oz, 4.75" Rimmed Fruit Bowl	02, 03, 05, 09, 14, 22, 42, 52	48 ea

NSF Listed products are designated with a Δ and may be prefixed with an N

Note: Melamine Dinnerware is not recommended for microwave

MELAMINE DINNERWARE

Dallas Ware set the industry standards by which all others are judged. **Quality and durability have been the Dallas Ware trademark for over 50 years.** The NSF listing on all Dallas Ware items ensures the highest sanitary standards.

Dallas Ware®

- Reinforced rim and foot design stacks with major competitors' products
- Meets PS25-70 specifications
- Safe for temperatures up to 212°F
- One-year limited warranty
- NSF Listed; dishwasher safe

Tabletop Accessories available in coordinating colors. See page 58 for more details



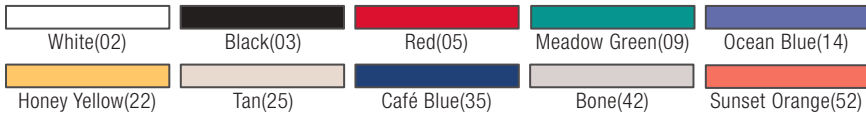

Prod No	Description	Color	Pack
Dallas Ware Narrow Rim Plates			
43500 Δ	10.25" Dinner Plate	02, 03, 05, 09, 14, 22, 25, 35, 42, 52	48 ea
43501 Δ	9" Dinner Plate	02, 03, 05, 09, 14, 22, 25, 35, 42, 52	48 ea
43503 Δ	7.25" Salad Plate	02, 03, 05, 09, 14, 22, 25, 35, 42, 52	48 ea
43504 Δ	6.5" Pie Plate	02, 25	48 ea
43505 Δ	5.63" Bread & Butter Plate	02, 25, 35	48 ea
Dallas Ware Compartment Plates			
43512 Δ	11", 1" D, 3-Compartment Plate	35	48 ea
43514 Δ	9.75", 1" D, 3-Compartment Plate	25, 35	36 ea
43516 Δ	9", 1.31" D, 3-Compartment Plate	02, 25	24 ea
Dallas Ware Oval Platters			
43560 Δ	12" x 8.5" Oval Platter	02, 03, 25, 35	24 ea
43563 Δ	9.25" x 6.25" Oval Platter	02, 03, 25, 35, 42	24 ea
Dallas Ware Bowls			
43520 Δ	16 oz, 5.75" Nappie Bowl	02, 25	48 ea
43521 Δ	14 oz, 5.5" Nappie Bowl	02, 03, 05, 09, 14, 22, 25, 35, 42, 52	48 ea
43522 Δ	14 oz, 5.5" Rim Nappie Bowl	02, 25, 35	24 ea
43525 Δ	13 oz, 5.25" Nappie Bowl	02, 25, 35	24 ea
43528 Δ	10 oz, 5" Nappie Bowl	02, 25, 35	48 ea
43529 Δ	10 oz, 5.88" Grapefruit Bowl	02, 03, 05, 09, 14, 22, 25, 35, 42, 52	48 ea
43531 Δ	4.75 oz, 4.5" Fruit Bowl	02, 25, 35	48 ea
43532 Δ	3.5 oz, 4.13" Fruit Bowl	02, 03, 05, 25, 35	48 ea
43533 Δ	6.5 oz Oval Fruit Dish	02	48 ea
43540 Δ	8 oz, 3.75" Bouillon Cup	02, 03, 05, 09, 14, 22, 25, 35, 42, 52	24 ea

NSF Listed products are designated with a Δ and may be prefixed with an N
 Note: Melamine Dinnerware is not recommended for microwave



MELAMINE DINNERWARE

Kingline is the top choice for **heavy-duty applications like school cafeterias.** Our medium weight melamine offers **beauty and durability at a great value.**

Kingline™

- All purpose, medium weight dinnerware meets the tough requirements of heavy-duty foodservice applications
- Durable gloss finish resists chipping, scratching, and staining
- Reinforced at vital stress points
- Save even more money with our exclusive Sandshades® variegated dinnerware
- Safe for temperatures up to 212°F
- One-year limited warranty
- NSF Listed; dishwasher safe

TOP CHOICE FOR SCHOOLS



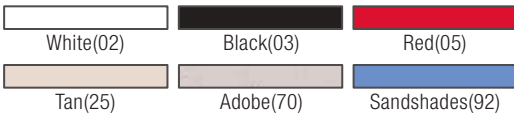

Prod No	Description	Color	Pack
Kingline Plates			
KL116 Δ	10" Dinner Plate	02, 03, 25	48 ea
KL200 Δ	9" Dinner Plate	02, 03, 05, 25, 70	48 ea
KL920 Δ	9" Dinner Plate	92	48 ea
KL201 Δ	7.25" Sandwich Plate	02, 03, 05, 25	48 ea
KL204 Δ	6.5" Pie Plate	02, 03, 05, 25	48 ea
KL205 Δ	5.5" Bread & Butter Plate	02, 25, 70	48 ea
Kingline Compartment Plates			
KL102 Δ	10", .75" D, 3-Compartment Plate	02, 25, 70	48 ea
KL203 Δ	8.75", 1.25" D, 3-Compartment Plate	02, 25	12 ea
Kingline Oval Platters			
KL126 Δ	13.5" x 9.75" Oval Platter	02, 25	12 ea
KL127 Δ	12" x 9" Oval Platter	02, 03, 05, 25, 70	12 ea
Kingline Bowls & Cup			
KL350 Δ	8 oz Bouillon Cup	02, 03, 05, 25	48 ea
KL115 Δ	16 oz, 6.13" Chowder Bowl	02, 25	48 ea
KL108 Δ	14 oz, 5.5" Nappie Bowl	02, 25	48 ea
KL119 Δ	12.5 oz, 5.5" Rimmed Nappie Bowl	02, 25	48 ea
KL924 Δ	12.5 oz, 5.5" Rimmed Nappie Bowl	92	48 ea
KL121 Δ	10 oz, 5.88" Grapefruit Bowl	02, 25	48 ea
KL118 Δ	10 oz, 5.13" Nappie Bowl	02, 03, 05, 25	48 ea
KL123 Δ	8 oz, 7.75" Wide Rimmed Salad Bowl	02	48 ea
KL800 Δ	5 oz, 5" Rimmed Fruit Bowl	02, 25, 70	48 ea
KL805 Δ	4.75 oz, 4.5" Rimmed Fruit Bowl	02, 03, 05, 25	48 ea
KL928 Δ	4.75 oz, 4.25" Rimmed Fruit Bowl	92	48 ea

NSF Listed products are designated with a Δ and may be prefixed with an N

Note: Melamine Dinnerware is not recommended for microwave

*Sandshades items vary in color, hue and intensity from piece to piece



MELAMINE DINNERWARE

As the sustainability trend continues to grow, sourcing fresh local food and using minimally invasive products in the front-of-house are more important than ever. **Dayton was designed with the environment in mind.** Make the eco friendly choice and choose Dayton.

Dayton™

- One of the most eco-friendly commercial grade melamines available on the market
- Classic design is available in 10 stylish colors
- Meets PS25-70 specifications insuring the weight, purity, and quality of our melamine
- Made from 50% sustainable natural resources vs. 20% in standard melamine
- Withstands the rigors of commercial foodservice dishwasher use
- Maintains its appearance after one year of dishwasher testing
- Dayton melamine is stain, scratch, and break-resistant, making it ideal for any foodservice operation
- Safe for temperatures up to 212°F
- One-year limited warranty
- Dishwasher safe



10 GREAT COLORS

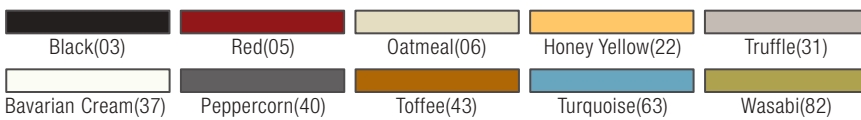

Prod No	Description	Color	Pack
Dayton Dinnerware Plates & Platters			
43850	10.25" Dinner Plate	03, 05, 22, 31, 37, 40, 43, 63, 82	48 ea
43852	9" Dinner Plate	03, 05, 06, 22, 31, 37, 40, 43, 63, 82	48 ea
43854	7.25" Salad Plate	03, 05, 06, 22, 31, 37, 63	48 ea
43856	5.63" Bread & Butter Plate	03, 05, 06, 22, 37, 63, 82	48 ea
43872	9.25" x 6.25" Oval Platter	05, 37	24 ea
Dayton Dinnerware Bowls & Cup			
43858	16 oz, 5.75" Nappie Bowl	03, 05, 06, 22, 31, 37, 63, 82	48 ea
43860	14 oz, 5.5" Rim Nappie Bowl	03, 05, 06, 22, 31, 37, 40, 63, 82	24 ea
43862	10 oz, 5" Nappie Bowl	03, 05, 06, 22, 37, 43, 63, 82	48 ea
43864	10 oz, 5.88" Grapefruit Bowl	03, 05, 06, 22, 31, 37, 43, 63, 82	48 ea
43866	4.75 oz, 4.5" Fruit Bowl	03, 05, 06, 22, 31, 37, 40, 63, 82	48 ea
43868	8 oz, 3.75" Bouillon Cup	03, 05, 06, 22, 31, 37, 40, 43, 63, 82	24 ea

Note: Melamine Dinnerware is not recommended for microwave



DINNERWARE ACCENT PIECES

Terra™

Terra Dinnerware Accents offer the exotic and earthy look of hand thrown pottery with the break resistance of heavy duty melamine. The organic design blends in with many food presentations and styles.

- The look of heavy-weight, hand thrown pottery blends into a variety of settings and offers an exceptional presentation
- Constructed of a unique, break-resistant material with the look and feel of ceramic
- Safe for temperatures up to 212°F
- One-year limited warranty
- NSF Listed; dishwasher safe



Square

As a tasting plate, an accent dish or the foundation for a grand buffet, square plates are on trend. Our square plates have rounded edges and the fine look of porcelain.

- Squares offer the look of ceramics in long-wearing melamine
- Three sizes hold everything from salads and appetizers to buffet style presentations
- Squared rim design is a sleek take on a classic look
- Made of heavy-duty, break-resistant melamine
- Safe for temperatures up to 212°F
- One-year limited warranty
- NSF Listed; dishwasher safe

Square Scoops

- Scoop shaped design holds sauces as well as appetizers or side dishes



Prod No	Description	Color	Pack
Terra Dinnerware			
43404 ▲	9.5" Terra Dinner Plate	03	12 ea
43410 ▲	9" Terra Square Plate	02	24 ea
43420 ▲	58 oz, 9.75" Terra Footed Bowl Pack	02,03	12 ea
43422 ▲	40 oz, 8.5" Terra Footed Bowl	02,03	12 ea
Square Dinnerware			
43308 ▲	8" Square Plate	02,03	48 ea
43306 ▲	9.5" Square Plate	02,03	48 ea
43304 ▲	11.5" Square Plate	02,03	48 ea
Square Scoops			
7940 ▲	2 oz, 3.5" Small Square Dish	02, 03	48 ea
7942 ▲	5 oz, 5.25" Small Square Dish	02, 03	48 ea

NSF Listed products are designated with a ▲ and may be prefixed with an N



Epicure®

The elegant coupe shape is the perfect frame for larger plating creations. Epicure's coupe shape lends European appeal in durable melamine.

- European coupe design combines strength and beauty with functionality
- Coupe design offers larger serving area
- Safe for temperatures up to 212°F
- Coordinates with Epicure Cased shown on page 30
- One-year limited warranty
- NSF Listed; dishwasher safe

Epicure® Shapes Tasting Plates

- One of a kind shapes add variety when serving appetizers, desserts, or specialty foods



Prod No	Description	Color	Pack
Epicure Dinnerware			
43800 Δ	12" Buffet/Pizza Plate	02	12 ea
43801 Δ	10" Dinner Plate	02	48 ea
43803 Δ	8" Dinner Plate	02	48 ea
5933 Δ	32 oz, 8.25" Vegetable Bowl	02	24 ea
43813 Δ	36 oz, 8" Chef Salad/Serving Bowl	02	12 ea
43814 Δ	20 oz, 6.5" Soup/Salad Bowl	02	12 ea
Epicure Shapes			
43806 Δ	11" TriArc Plate	02, 03	4 ea
43822 Δ	6.25" Square Plate	02	48 ea

NSF Listed products are designated with a Δ and may be prefixed with an N



DINNERWARE

Commercial Dinnerware

Polycarbonate material resists stains and chipping

- Designed for corrections, hospitals, schools, long term care facilities, or anywhere long product life and economy are important
- Super-tough polycarbonate dinnerware offers a five-year guarantee against breakage
- Plates have scratch-resistant textured surface
- Stacks with other polycarbonate dinnerware currently on the market
- Temperature use range: -40° to 212°F
- Five-year limited warranty
- NSF Listed; dishwasher safe



Prod No	Description	Color	Pack
Commercial Dinnerware Plates			
PCD210 ▲	10" Narrow Rim Plate	02, 03, 25, 50, 59	48 ea
PCD209 ▲	9" Narrow Rim Plate	02, 03, 15, 25, 50, 59	48 ea
PCD207 ▲	7.25" Narrow Rim Plate	25	48 ea
PCD206 ▲	6.5" Narrow Rim Plate	02, 03, 50, 59	48 ea
PCD205 ▲	5.5" Narrow Rim Plate	02, 03	48 ea
Commercial Dinnerware Compartment Plates			
PCD211 ▲	11" Narrow Rim 3-Compartment Plate, 1.25" deep	03, 25	48 ea
PCD220 ▲	9" Narrow Rim 3-Compartment Plate, 1" deep	02, 59	48 ea
Commercial Dinnerware Oval Platter			
PCD412 ▲	12" x 9" Oval Platter	02, 03, 50	24 ea
Commercial Dinnerware Bowls & Cup			
PCD319 ▲	15 oz, 5.25" Nappie Bowl	02, 03, 25, 50	48 ea
PCD312 ▲	12 oz, 9" Soup Bowl	02, 03	48 ea
PCD310 ▲	10 oz, 4" Square Bowl	02	48 ea
PCD313 ▲	10 oz, 6" Rimmed Grapefruit Bowl	02, 59, 25	48 ea
PCD316 ▲	10 oz, 5" Nappie Bowl	03	48 ea
PCD308 ▲	8.4 oz, 4" Bouillon Cup	02, 15	48 ea
PCD305 ▲	5 oz, 3.5" Rimmed Fruit Bowl	02, 03, 15, 25, 50, 59	48 ea
Commercial Dinnerware Mug			
PCD796 ▲	9.6 oz Mug	02, 25	48 ea

NSF Listed products are designated with a [▲](#) and may be prefixed with an N

Tulip Dishes

- Ideal for serving ice cream, puddings, salads, and more
- Stack with similar glass or plastic dessert dishes
- Made of break-resistant SAN
- 4532, 4534 are also available in extra-durable polycarbonate
- Tulip Dishes are the perfect compliment to the Coldmaster® Ice Cream Server shown below
- NSF Listed; dishwasher safe



Ice Cream Server & Lid

- Coldmaster technology and benefits (see pages 108 – 115)
- Accommodates standard 3-gallon ice cream tubs
- Free, clear polycarbonate lid included with each Coldmaster Ice Cream Server
- Replacement Lids (CM1013) also available



Ice Cream Shroud

- Attractive stainless steel cover offers an upscale appearance



Prod No	Description	Color	Pack
Tulip Dishes			
4530 Δ	5 oz, 3.75" SAN Tulip Dessert Dish	03, 07, 42, 54, 55	24 ea
4532 Δ	5 oz, 3.75" PC Tulip Dessert Dish	07	24 ea
4531 Δ	5 oz, 4.63" SAN Tulip Berry Dish	03, 07, 42	24 ea
4535 Δ	8 oz, 4.63" SAN Tulip Berry Dish	07	48 ea
4533 Δ	13 oz, 5.5" SAN Tulip Bowl	07	24 ea
4534 Δ	13 oz, 5.5" PC Tulip Bowl	07	24 ea
Coldmaster Ice Cream Server, Lid & Shroud			
CM1012 Δ	3 gal Coldmaster Ice Cream Server	02, 03	1 ea
CM1013	Lid for Coldmaster Ice Cream Server	07	1 ea
38655	Coldmaster Ice Cream Shroud	—	1 ea

NSF Listed products are designated with a Δ and may be prefixed with an N

PLATES & BOWLS

Tough polycarbonate Petal Mist

provides heavy duty serving pieces with a design that looks great longer! Textured exterior hides scratches. Smooth interior makes it easy to clean.

Petal Mist®

- Perfect for buffets, food bars, delis, poolside, and catering
- Made of tough, break-resistant polycarbonate
- Textured exterior hides scratches; smooth interior is easy to clean
- Safe for use in freezers and in temperatures from 40° to 212°F
- See page 94 for additional Petal Mist trays and bowls
- NSF Listed; dishwasher safe



Leaf Plates

- Intricate leaf pattern enhances food appearance
- Molded of durable SAN for long life
- Dishwasher safe



Prod No	Description	Color	Pack
Petal Mist Plates & Bowls			
6904 Δ	18 oz, 6" Petal Mist Bowl	03, 07	36 ea
6954 Δ	7.5" Petal Mist Plate	07	36 ea
6907 Δ	23.9 oz, 8" Petal Mist Soup/Salad Plate	07	36 ea
6956 Δ	9" Petal Mist Plate	07	36 ea
Leaf Plates			
0345	6" Leaf Plate	07	36 ea
0347	9" Leaf Plate	07	12 ea

NSF Listed products are designated with a Δ and may be prefixed with an N

Melamine Salad Bowls

- Made of dependable, impact-resistant melamine
- Safe for temperatures up to 212°F
- NSF Listed; dishwasher safe



Charger Plates

- Beautiful mirror-finish charger plates are an elegant addition to any place setting
- Easy care tarnish-resistant finish
- Hand wash only



Prod No	Description	Color	Pack
Melamine Salad Bowls			
500B Δ	8 oz, 5.5" Melamine Salad Bowl	03	72 ea
575B Δ	13 oz, 6" Melamine Salad Bowl	03	72 ea
650B Δ	20 oz, 6.5" Melamine Salad Bowl	03	72 ea
800B Δ	24 oz, 7.5" Melamine Salad Bowl	03	48 ea
500M Δ	10 oz, 5.5" Melamine Salad Bowl	20	72 ea
575M Δ	10 oz, 6" Melamine Salad Bowl	20	72 ea
650M Δ	20 oz, 6.5" Melamine Salad Bowl	20	72 ea
800M Δ	27 oz, 7.5" Melamine Salad Bowl	20	48 ea
Charger Plates			
608924	12.25" Charger Plate, Chrome	–	12 ea

NSF Listed products are designated with a Δ and may be prefixed with an N

SERVING PIECES

Mid-century modern beauty paired with the **durability of Tritan.**

Epicure Cased

- Gorgeous color is encased between two layers of Tritan and won't wear off
- Durable Tritan is break and craze-resistant
- Withstands temperatures from -40°F to 180°F
- Resistant to staining, breaking and chipping
- NSF Listed; dishwasher safe
- BPA free
- Two-year limited warranty



The Carlisle
TABLETOP
COLLECTION

Coordinating drinkware & pitchers listed on pages 38 & 53



Prod No	Description	Color	Pack
Epicure Cased Servingware			
EP20	5.5", 17 oz Small Bowl	02, 15, 18	12 ea
EP10 Δ	10", 96 oz Bowl	02, 15, 18	6 ea

NSF Listed products are designated with a **Δ** and may be prefixed with an N

Microwave-Ware

- Polycarbonate serving accessories designed specifically for microwave cooking
- Stays cool to the touch when coming out of the microwave
- Extremely impact resistant
- Small 8 oz Casserole is perfect for salads and sides—easily doubles as an olive, nut or butter dish on buffets
- Temperature use range: -40° to 212°F
- Dishwasher safe



Prod No	Description	Color	Pack
Microwave-Ware			
7400 Δ	12 oz, 5.25" x 8.75" Oval Casserole	02	24 ea
7405 Δ	8 oz, 4.25" x 7.5" Oval Casserole Dish	02, 03	24 ea
7410	10 oz, 4" Jumbo Soup Mug	02	24 ea
7420	12 oz, 5.25" Handled Soup Bowl	02	24 ea

Soup Service

- Hefty, thick-walled designs keep food and beverages hot
- Stackable 12 oz Jumbo Soup/Latté Mug (4512) has polycarbonate inner liner and SAN exterior
- 8 and 12 oz handled bowls stack for storage; easy-grab handles are perfect for buffet lines



Prod No	Description	Color	Pack
Soup Service			
7006	8 oz, 4.63" Handled Soup Bowl	09, 14, 19, 22, 28, 52	24 ea
7008	12 oz, 5.25" Handled Soup Bowl	19, 28	24 ea
4512	12 oz, 5.5" Jumbo Soup/Latté Mug with White Liner	19, 28	24 ea

NSF Listed products are designated with a Δ and may be prefixed with an N

PLATE COVERS

Polyglass Plate Covers

- Available to fit a wide variety of plate sizes and footprints
- Polyglass (PG) plate covers are designed for use in microwaves and heated carts
- Heat resistant to 270°F yet stays cool to the touch; excellent insulation properties
- Impact-resistant material offers a superior alternative to standard fiberglass covers
- NSF Listed; dishwasher safe



Polycarbonate Plate Covers

- Clear covers for easy viewing of food
- Highly heat- and break-resistant
- 1960 and 1992 also fit European “pin-fired” footless style plates for secure stacking
- Can be used in heated carts or under heat lamps up to 212°F
- Dishwasher safe



Prod No	Description	Color	Pack
Polyglass Plate Covers			
91020 Δ	8.75" – 9.13" Polyglass Cover	202	12 ea
91040 Δ	9.5" – 10" Polyglass Cover	202	12 ea
91055 Δ	10.13" – 10.5" Polyglass Cover	202	12 ea
91070 Δ	10.25" – 10.63" Polyglass Cover	202	12 ea
91065 Δ	10.13" – 10.38" Polyglass Cover	202	12 ea
91080 Δ	10.5" – 10.75" Polyglass Cover	202, 203	12 ea
91075 Δ	10.63" – 10.69" Polyglass Cover	202	12 ea
91085 Δ	11" – 11.25" Polyglass Cover	202	12 ea
91090 Δ	11.75" – 12" Polyglass Cover	202	12 ea
91095 Δ	12" – 12.25" Polyglass Cover	202	12 ea
Polycarbonate Plate Covers			
1900	8.69" to 9.13" PC Cover	07	12 ea
1960	9" Combination "Pin-Fired" Plate & Bowl PC Cover	07	12 ea
1965	9.44" to 9.75" PC Cover	07	12 ea
1987	9.81" to 10" PC Cover	07	12 ea
1989	10.81" to 10.25" PC Cover	07	12 ea
1991 Δ	10.5" to 10.63" PC Cover	07	12 ea
1992 Δ	10.5" to 10.63" "Pin-Fired" PC Cover	07	12 ea
1993	10.75" to 11" PC Cover	07	12 ea
1994	12" PC Cover	07	12 ea

NSF Listed products are designated with a Δ and may be prefixed with an N

Custom Acrylic Plate Covers

- Excellent for keeping food warm
- Made to order for undersized or oversized plates and platters
- Use for table service or patient serving
- Dishwasher safe up to 180°F

CUSTOMIZE

Custom Plate Covers

Ordering information

- Minimum order – four dozen (48 ea)
- Two samples of each item are required for quote
- Please allow four to six (4-6) weeks for delivery of samples
- Custom plate cover orders require customer approval of samples prior to production
- If cover has not been previously molded, additional tooling charges apply
- A size variance of .13" is possible in the manufacturing of this product
- Larger and smaller sizes of custom covers by special quotation only
- Custom covers are not returnable



Note: Do not use Acrylic Plate Covers in heated carts, under heat lamps, or near exposed heat sources; safe for temperatures under 130°F

Translucent White(02) Clear(07)

Prod No	Description	Color	Pack
Custom Acrylic Clear Round Plate Covers			
Group A	7" And Under Acrylic Round Cover	07	24 ea
Group B	7.06" – 8" Acrylic Round Cover	07	24 ea
Group C	8.06" – 10" Acrylic Round Cover	07	24 ea
Group D	10.06" – 14" Acrylic Round Cover	07	24 ea
Group E	14.06" – 16" Acrylic Round Cover	07	24 ea
Custom Acrylic Translucent Round Plate Covers			
Group AT	7" And Under Acrylic Round Cover	02	24 ea
Group BT	7.06" – 8" Acrylic Round Cover	02	24 ea
Group CT	8.06" – 10" Acrylic Round Cover	02	24 ea
Group DT	10.06" – 14" Acrylic Round Cover	02	24 ea
Group ET	14.06" – 16" Acrylic Round Cover	02	24 ea
Custom Acrylic Clear Oval Plate Covers			
Group P1	11" And Under Acrylic Oval Cover	07	24 ea
Group P2	11.06" – 12.5" Acrylic Oval Cover	07	24 ea
Group P3	12.56" – 14" Acrylic Oval Cover	07	24 ea
Group P4	14.06" – 16" Acrylic Oval Cover	07	24 ea
Custom Acrylic Translucent Oval Plate Covers			
Group P1T	11" And Under Acrylic Oval Cover	02	24 ea
Group P2T	11.06" – 12.5" Acrylic Oval Cover	02	24 ea
Group P3T	12.56" – 14" Acrylic Oval Cover	02	24 ea
Group P4T	14.06" – 16" Acrylic Oval Cover	02	24 ea

NSF Listed products are designated with a **Δ** and may be prefixed with an N



CARLISLE
FOODSERVICE PRODUCTS



CLASSIC
INVITING
ENDURING
BEAUTIFUL
EYE-CATCHING
DRINKWARE

Carlisle offers a complete line of barware, stemware, and serveware. Let us help you dress your bar and restaurant with our complete line of break-resistant beverage service products.



DRINKWARE

Alibi's sophisticated styling provides an **updated look to any beverage service.**

Alibi™ Barware

- Barware is light-weight yet durable SAN
- Great for outdoor & poolside use
- Has the look and feel of glass without the worry of breakage
- Custom decorating available; see pages 330 – 331
- BPA free
- Dishwasher safe



Clear(07)

Prod No	Description	Glass Rack	Color	Pack
Alibi Barware				
5601	1.5 oz Alibi Shot	RG49	07	24 ea
5602	2 oz Alibi Shooter	RG49	07	24 ea
5603	3 oz Alibi Shooter/Mini Dessert	RG49	07	24 ea
5609	9 oz Alibi Rocks/Juice	RG25-1	07	24 ea
5610	10 oz Alibi Hi-Ball	RG49-2	07	24 ea
5612	12 oz Alibi Double Old Fashioned	RW20	07	24 ea
5614	14 oz Alibi Beverage	RW30-1	07	24 ea
5616	16 oz Alibi Pint/Mixing	RW20-1	07	24 ea
5646	9 oz Alibi Martini	RG9-3	07	24 ea

Alibi™ Stemware

- Made of break-resistant polycarbonate
- Great for special occasions and outdoor events
- Thick base & thin stem mimics traditional glassware
- Dishwasher safe



Clear(07)

Prod No	Description	Glass Rack	Color	Pack
Alibi Drinkware & Stemware				
5644	6 oz Alibi Champagne Flute	RW30-3	07	24 ea
5640	8 oz Alibi Champagne Flute	RE25-5	07	24 ea
5645	8 oz Alibi White Wine	RG16-4	07	24 ea
5643	11 oz Alibi White Wine	RW30-2	07	24 ea
5642	20 oz Alibi Red Wine	RG16-4	07	24 ea
5641	22 oz Alibi Balloon	RG16-4	07	24 ea
5647	12 oz Cocktail	RG25-4, RW20-3	07	24 ea
5648	15 oz Water	RG25-3, RW20-2	07	24 ea
5649	16 oz Pilsner	RG25-5, RW20-4	07	24 ea
5650	16 oz Hurricane	RG25-4, RW20-3	07	24 ea
5651	11 oz Margarita	RG9-3	07	24 ea
5652	16 oz Margarita, Grande	RG9-3	07	24 ea



The look of recycled glass, the durability of Tritan plastic.

Mingle

- The look and feel of recycled glass drinkware
- Tritan offers durability that withstands the heavy use in your venue
- Durable Tritan is break and craze-resistant
- Stain resistant
- BPA Free
- NSF Listed; dishwasher safe
- Two-year limited warranty



Coordinating pitcher & bowls listed on pages 52 & 30

Mid-century modern beauty paired with the durability of Tritan.

Epicure Cased

- Gorgeous color is encased between 2 layers of Tritan and won't wear off
- Durable Tritan is break and craze-resistant
- Withstands temperatures from -40°F to 180°F
- Resistant to staining, breaking and chipping
- NSF Listed; dishwasher safe
- BPA free
- Two-year limited warranty



Coordinating pitcher listed on page 52



Prod No	Description	Glass Rack	Color	Pack
Mingle Drinkware				
MIN5440 Δ	14 oz Double Old Fashioned	RW20	02, 07, 15, 18	12 ea
MIN5441 Δ	6 oz Juice Cup	RG36-1	02, 07, 15, 18	12 ea
MIN5442 Δ	19 oz Highball	RW20-1	02, 07, 15, 18	12 ea
MIN5449 Δ	22 oz High Ball	RW20-2	07	12 ea
Epicure Cased Drinkware				
EP40 Δ	22 oz Highball	RG16-3	02, 15, 18	12 ea
EP50 Δ	14 oz Double Old Fashioned	RW20	02, 15, 18	12 ea
EP60 Δ	15 oz Wine Goblet	RW20-2	02, 15, 18	12 ea
EP70 Δ	16.5 oz Wine Goblet	RW20-3	02, 15, 18	12 ea
EP90 Δ	12 oz Goblet	RG16-4	02, 15, 18	12 ea
EP100 Δ	10 oz Goblet	RW20-3	02, 15, 18	12 ea

NSF Listed products are designated with a Δ and may be prefixed with an N

DRINKWARE

Astaire's **contemporary** design has the added bonus of **durable** polycarbonate. **Elegant** and break-resistant, it is perfect for everything from parties to poolside service.

Astaire

- Sleek contemporary design is reminiscent of fine European crystal
- Stemless wine glass is the perfect choice for events that require additional stability
- Made of durable polycarbonate
- Excellent choice for outdoor and poolside events where breakage is a concern



RECOMMENDED GLASS RACK IS LISTED IN THE PRODUCT CHART



Clear(07)

Prod No	Description	Glass Rack	Color	Pack
Astaire Stemware				
49500	6 oz Astaire Flute	RG36-4, RW30-3	07	12 ea
49501	11 oz Astaire Martini	RG9-3	07	12 ea
49502	13 oz Astaire White Wine	RG25-4, RW20-3	07	12 ea
49503	13 oz Astaire Stemless Wine	RG16-1	07	12 ea
49504	14 oz Astaire All Purpose	RG25-3, RW20-2	07	12 ea
49505	18 oz Astaire Iced Tea	RG25-3, RW20-2	07	12 ea
49506	22 oz Astaire Red Wine	RG9-4	07	12 ea



SAN TUMBLERS

Carlisle leads the industry in **durable SAN Tumblers**. The variety of sizes, finishes, and decorating opportunities are sure to **satisfy all of your tumbler needs**.

Stackable

- Durable SAN reduces breakage
- Tapered sides make tumblers easy to stack
- Interior lugs prevent jamming when stored
- Textured exterior hides wear and tear
- Custom decorating available; see pages 330 – 331
- BPA free
- NSF Listed; dishwasher safe

Note: Please specify case pack when ordering



RECOMMENDED GLASS RACK IS LISTED IN THE PRODUCT CHART



Clear(07)	Ruby(10)	Amber(13)	Royal Blue(47)	Blue(54)
-----------	----------	-----------	----------------	----------

Prod No	Description	Disposable Lid	Glass Rack	Color	Pack
SAN – Large Packs					
5501 Δ	5 oz SAN Stackable Tumbler	DX1193ST8714*	RG49-1	07, 10, 13, 47, 54	72 ea
5526 Δ	8 oz SAN Stackable Tumbler	DX1191ST8714*	RG49-1	07, 10, 13, 47, 54	72 ea
5529 Δ	9 oz Old Fashioned SAN Stackable Tumbler	DXTT58*	RG25-1	07, 10, 13	72 ea
5506 Δ	9.5 oz SAN Stackable Tumbler	5506L	RG49-1	07, 10, 13, 47, 54	72 ea
5212 Δ	12 oz SAN Stackable Tumbler	5212L	RG25-2	07, 10, 13, 47, 54	72 ea
5216 Δ	16 oz SAN Stackable Tumbler	DXTT58*	RG25-2	07, 10, 13, 47, 54	72 ea
5220 Δ	20 oz SAN Stackable Tumbler	DX30008714*	RW20-2	07, 10, 13, 47, 54	72 ea
5224 Δ	24 oz SAN Stackable Tumbler	DXTT45*	RG16-3	07, 10, 13	72 ea
5232 Δ	32 oz Tall SAN Stackable Tumbler	—	RG16-3	07, 10	24 ea
5532 Δ	32 oz SAN Stackable Tumbler	—	RG16-3	07, 10, 13	48 ea
43937 Δ	5.5 oz Low Profile SAN Stackable Tumbler	—	RW20	07	72 ea
SAN – Small Packs					
5501-2 Δ	5 oz SAN Stackable Tumbler	DX1193ST8714*	RG49-1	07	24 ea
5526-2 Δ	8 oz SAN Stackable Tumbler	—	RG49-1	07	24 ea
5529-2 Δ	9 oz Old Fashioned SAN Stackable Tumbler	DXTT58*	RG25-1	07	24 ea
5532-2 Δ	32 oz SAN Stackable Tumbler	—	RG16-3	07	24 ea
5506-2 Δ	9.5 oz SAN Stackable Tumbler	5506L	RG49-1	07	24 ea
5212-2 Δ	12 oz SAN Stackable Tumbler	5212L	RG25-2	07	24 ea
5216-2 Δ	16 oz SAN Stackable Tumbler	DXTT58*	RG16-2	07	24 ea
5220-2 Δ	20 oz SAN Stackable Tumbler	DX30008714*	RW20-2	07	24 ea

NSF Listed products are designated with a Δ and may be prefixed with an N

Note: *The DX Series Disposable Lids listed above are available through our Dinetex Catalog



Genuine Coca-Cola® & Pepsi® Stackable Tumblers

- Same features as our regular SAN Stackable Tumblers
- Printed with the famous Coca-Cola® or Pepsi® trademark
- BPA free

Items are Trademarked by the Coca-Cola® Company. Coca-Cola® Stackable Tumblers are available for distribution only to authorized Coca-Cola® fountain customers for commercial foodservice use. Coca-Cola® Stackable Tumblers cannot be used for retail sale to the public.

Items are Trademarked by PepsiCo®. PepsiCo® Stackable Tumblers are available for distribution only to authorized PepsiCo® fountain customers for commercial foodservice use. PepsiCo® Stackable Tumblers cannot be used for retail sale to the public.



Prod No	Description	Disposable Lid	Glass Rack	Pack
Coca-Cola Stackable Tumblers				
52163550E	16 oz Coca-Cola Tumbler, Clear	DXTT58*	RG25-2	72 ea.
52203550A	20 oz Coca-Cola Tumbler, Clear	DX30008714*	RW20-2	72 ea.
52243550G	24 oz Coca-Cola Tumbler, Clear	DXTT45*	RG16-3	72 ea.
5232-63550J	32 oz Coca-Cola Tumbler, Clear	—	RG16-3	72 ea.
52163550D	16 oz Coca-Cola Tumbler, Ruby	DXTT58*	RG25-2	72 ea.
52203550	20 oz Coca-Cola Tumbler, Ruby	DX30008714*	RW20-3	72 ea.
52243550H	24 oz Coca-Cola Tumbler, Ruby	DXTT45*	RG16-3	72 ea.
5232-63550I	32 oz Coca-Cola Tumbler, Ruby	—	RG16-3	72 ea.
Pepsi Stackable Tumblers				
5216841C2	16 oz Pepsi Clear Script	DXTT58*	RG25-2	72 ea.
52163841A	16 oz Pepsi Ice Blue Script	DXTT58*	RG25-2	72 ea.
52163841F	16 oz Pepsi Royal Blue Script	DXTT58*	RG25-2	72 ea.
5216C203	16 oz Pepsi Clear Globe	DXTT58*	RG25-2	72 ea.
5216RB203	16 oz Pepsi Royal Blue Globe	DXTT58*	RG25-2	72 ea.
5216IB203	16 oz Pepsi Ice Blue Globe	DXTT58*	RG25-2	72 ea.
5220841C2	20 oz Pepsi Clear Script	DX30008714*	RW20-2	72 ea.
52203841B	20 oz Pepsi Ice Blue Script	DX30008714*	RW20-2	72 ea.
52203841G	20 oz Pepsi Royal Blue Script	DX30008714*	RW20-2	72 ea.
5220C203	20 oz Pepsi Clear Globe	DX30008714*	RW20-2	72 ea.
5220RB203	20 oz Pepsi Royal Blue Globe	DX30008714*	RW20-2	72 ea.
5220IB203	20 oz Pepsi Ice Blue Globe	DX30008714*	RW20-2	72 ea.
5224841C2	24 oz Pepsi Clear Script	DXTT45*	RG16-3	72 ea.
52243841C	24 oz Pepsi Ice Blue Script	DXTT45*	RG16-3	72 ea.
52243841H	24 oz Pepsi Royal Blue Script	DXTT45*	RG16-3	72 ea.
5224C203	24 oz Pepsi Clear Globe	DXTT45*	RG16-3	72 ea.
5224RB203	24 oz Pepsi Royal Blue Globe	DXTT45*	RG16-3	72 ea.
5224IB203	24 oz Pepsi Ice Blue Globe	DXTT45*	RG16-3	72 ea.
5232841C2	32 oz Pepsi Clear Script	—	RG16-3	24 ea.
52323841D	32 oz Pepsi Ice Blue Script	—	RG16-3	24 ea.
52323841I	32 oz Pepsi Royal Blue Script	—	RG16-3	24 ea.
5232C203	32 oz Pepsi Clear Globe	—	RG16-3	24 ea.
5232RB203	32 oz Pepsi Royal Blue Globe	—	RG16-3	24 ea.
5232IB243	32 oz Pepsi Ice Blue Globe	—	RG16-3	24 ea.

Note: *The DX Series Disposable Lids listed above are available through our Dinex Catalog



SAN TUMBLERS

Louis Tumblers are a **timeless shape in the history of beverage ware.** Ours is perfect for service where breakage is a concern. **Well balanced with the feel of heavy glass.**



RECOMMENDED GLASS RACK IS LISTED IN THE PRODUCT CHART



Louis™

- Faceted shape offers easy grip
- Appearance of glass
- Made of break-resistant SAN
- Stackable space saving feature
- Custom decorating available; contact Customer Service at 1-800-654-8210 for custom imprinting information
- BPA free
- NSF Listed; dishwasher safe



An attractive, classic workhorse tumbler collection. **Perfect for healthcare and hospitals.**



Lorraine™

- Attractive panel and facet design
- Made of break-resistant SAN
- 43649—9 oz Old Fashioned is designed for healthcare tray service, bar or room service
- 43647—6 oz size meets healthcare portion standards
- Stacking lugs prevent jamming
- BPA free
- Dishwasher safe



Clear(07)

Prod No	Description	Disposable Lid	Glass Rack	Color	Pack
Louis SAN Tumblers					
5806 Δ	6 oz Louis Tumbler	DX11968714*	RG36-1	07	24 ea
5808 Δ	8 oz Louis Rocks	DX22259000*	RG36-1	07	24 ea
5810 Δ	10 oz Louis Tumbler	5810L	RG25-1	07	24 ea
5812 Δ	12 oz Louis Rocks	5812L	RG25-1	07	24 ea
5814 Δ	14 oz Louis Tumbler	DXTT501*	RG25-2	07	24 ea
5816 Δ	16 oz Louis Tumbler	DXTT58*	RG25-2	07	24 ea
5818 Δ	18 oz Louis Tumbler	DXTT58*	RW20-1	07	24 ea
5820 Δ	20 oz Louis Tumbler	—	RW20-1	07	24 ea
5822 Δ	22 oz Louis Tumbler	5822L	RW20-2	07	24 ea
5832 Δ	32 oz Louis Tumbler	—	RG16-3	07	24 ea
Lorraine SAN Tumblers					
43647	6 oz Lorraine Tumbler	—	RG36-1	07	24 ea
43648	8 oz Lorraine Tumbler	1110L	RW30	07	24 ea
43649	9 oz Lorraine Old Fashioned Tumbler	DXTT59*	RW20	07	24 ea
43651	12 oz Lorraine Tumbler	—	RG25-2	07	24 ea
43653	16 oz Lorraine Tumbler	DX30008714*	RW20-1	07	24 ea
43655	22 oz Lorraine Tumbler	—	RG16-2	07	24 ea

NSF Listed products are designated with a Δ and may be prefixed with an N

Note: *The DX Series Disposable Lids listed above are available through the Carlisle | Dinox Catalog



Inspired by a long cherished French bar ware design, **Bistro is an agile design that you can employ in high end restaurants and small town diners alike.** Bistro never goes out of style.

Bistro™

- Attractive traditional fluted exterior
- Interior lugs prevent jamming when stored
- Made of break-resistant SAN
- BPA free
- Dishwasher safe



The perfect stacking tumbler to use in healthcare and other **situations where a better grip is helpful.**

Crystalon® Stack-All®

- Stylish, ribbed texture offers better grip
- Made of break-resistant SAN
- Stacking lugs prevent jamming when stored
- BPA free
- Dishwasher safe

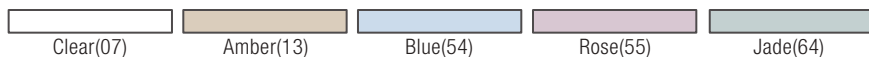

Prod No	Description	Disposable Lid	Glass Rack	Color	Pack
Bistro SAN Tumblers					
1104	4 oz Bistro Tumbler	—	RG49-1	07	144 ea
1105	5 oz Bistro Tumbler	DX11928714*	RG36-1	07	144 ea
1108	8 oz Bistro Tumbler	—	RW30	07	72 ea
1110	10 oz Bistro Tumbler	1110L	RW30	07	72 ea
1112	12 oz Bistro Tumbler	1112L	RW30-1	07	72 ea
1116	16 oz Bistro Tumbler	—	RG25-2	07	72 ea
0120	20 oz Bistro Tumbler	DX21259000*	RW20-2	07	72 ea
0132	32 oz Bistro Tumbler	—	RG9-3	07	48 ea
Crystalon SAN Stack-All Tumblers					
4008	8 oz Crystalon SAN Tumbler	DX1198ST8714*	RW30	07, 55	48 ea
4029	9 oz Old Fashioned Crystalon SAN Tumbler	DX21259000*	RW20	07, 13, 55, 64	48 ea
4010	9.5 oz Crystalon SAN Tumbler	43635L	RW30	07, 54	48 ea
4012	12 oz Crystalon SAN Tumbler	5212L	RG25-2	07, 13, 54, 55, 64	48 ea
4016	16 oz Crystalon SAN Tumbler	DXTT58*	RW20-1	07, 13, 54, 55, 64	48 ea
4020	20 oz Crystalon SAN Tumbler	—	RW20-1	07, 13, 54, 55, 64	48 ea

Note: *The DX Series Disposable Lids listed above are available through the Carlisle | Dinex Catalog

SAN TUMBLERS

Genuine Coca-Cola® Tumbler

- Classic shape with the appearance of glass
- Dishwasher safe; stackable
- Available in clear with Coca-Cola® logo
- Break-resistant
- BPA free SAN

These items are Trademarked by the Coca-Cola® Company. Coca-Cola® Stackable Tumblers are available for distribution only to authorized Coca-Cola® fountain customers for commercial foodservice use. Coca-Cola® Stackable Tumblers cannot be used for retail sale to the public.



439945200

The tried and true diner tumblers continue to delight customers around the world.

Pebble Optic™

- Attractive pebbled exterior hides scratches
- Thick-walled SAN construction offers sturdy feel
- 5 oz, 8 oz, 9.5 oz, and 12 oz sizes have stacking feature on bottom
- BPA free
- Dishwasher safe



Prod No	Description	Disposable Lid	Glass Rack	Color	Pack
Genuine Coca-Cola Tumbler					
439945200	24 oz Coca-Cola Tumbler with Logo		RW20-2	—	72 ea
Pebble Optic Tumblers					
5505	5 oz Pebble Optic Tumbler	DX24019000*	RG36-1	07	24 ea
5508	8 oz Pebble Optic Tumbler	—	RG36-1	07	24 ea
5509	9.5 oz Pebble Optic Tumbler	—	RW30	07, 10, 18	24 ea
5512	12 oz Pebble Optic Tumbler	DX1198ST8714*	RG36-2	07, 10, 18	24 ea
5517	16 oz Pebble Optic Tumbler	—	RG25-2	07, 10, 18	24 ea
5519	20 oz Pebble Optic Tumbler	DX11948714	RG25-3	07	24 ea

Note: *The DX Series Disposable Lids listed above are available through our Dinx Catalog

POLYCARBONATE DRINKWARE

Soon becoming our classic barware line. Trusted by pool management to **delight customers without the worry of breakage.**

Liberty™

- Serve poolside drinks without the breakage worries of glass
- Liberty polycarbonate eliminates the need to sacrifice your presentation with disposables
- Custom decorating available; see pages 330 – 331
- Dishwasher safe



Clear(07)

Prod No	Description	Glass Rack	Color	Pack
Liberty Drinkware				
43628	8 oz Liberty Old Fashioned	RW30	07	48 ea
43625	18 oz Liberty Double Old Fashioned	RW20-1	07	24 ea
43626	22 oz Liberty Hi-Ball	RW20-2	07	24 ea
43623	15 oz Liberty Pilsner	RW20-3	07	24 ea
43624	9.5 oz Liberty Margarita	RG9-2	07	24 ea
43627	8 oz Liberty Martini	RG9-2	07	24 ea
43629	9 oz Liberty Cocktail	RG25-2	07	24 ea
43620	5 oz Liberty Champagne Flute	RG25-4	07	24 ea
43631	15 oz Liberty Hurricane	RG25-4	07	24 ea
43630	13 oz Liberty Cocktail	RG25-3	07	24 ea
43621	10.5 oz Liberty White Wine	RW20-2	07	24 ea
43622	13.5 oz Liberty Goblet	RG16-3	07	24 ea

POLYCARBONATE TUMBLERS

A **fun color grouping** that is a perfect look for poolside or barbeques where breakage is a concern.

Crystalon® RimGlow™

- Tumblers change hue and intensity with variations in lighting, perspective, and beverage color
- Mix and match colors in brilliant, long-lasting polycarbonate
- Coordinates with Caribbean color dinnerware shown in the Dinnerware section of this catalog
- Dishwasher safe

4035



Stackable

- Ideal for prisons, schools, and high-volume chains
- Extremely break-resistant polycarbonate extends tumbler life
- Dishwasher safe



RECOMMENDED GLASS RACK IS LISTED IN THE PRODUCT CHART

5108-2



5120



5116-2



5105-2



Prod No	Description	Disposable Lid	Glass Rack	Color	Pack
Crystalon Polycarbonate RimGlow Tumblers					
4033	12 oz Crystalon PC Tumbler	5212L	RG25-2	09, 14, 22, 52	48 ea
4034	16 oz Crystalon PC Tumbler	DXTT58*	RW20-1	07, 09, 14, 22, 52	48 ea
4035	20 oz Crystalon PC Tumbler	—	RW20-1	09, 14, 22, 52	48 ea
Polycarbonate Stackable Tumblers					
5105-2	5 oz PC Stackable Tumbler	DX1193ST8714*	RG49-1	07	24 ea
5108-2	8 oz PC Stackable Tumbler	—	RG49-1	07	24 ea
5109-2	9.5 oz PC Stackable Tumbler	5109L	RG49-1	07	24 ea
5116-2	16.5 oz PC Stackable Tumbler	DX22259000*	RG25-2	07, 10	24 ea
5120	20 oz PC Stackable Tumbler	DX30008714*	RW20-2	07	24 ea

Note: *The DX Series Disposable Lids listed above are available through the Carlisle | Dinetex Catalog



Swirl

- Unique swirl design creates a perfect, glass-like tabletop beverage presentation
- Dishwasher safe



Another perfect design from the masters at Carlisle. **Six sizes available for all of your bar needs.**

Lafayette®

- Distinctive fluted pattern has the look and style of glass
- Perfect for bar service, room service, or catered events
- Stacking lugs prevent jamming
- Slotted base allows complete draining
- Dishwasher safe



Clear(07)

Prod No	Description	Disposable Lid	Glass Rack	Color	Pack
Swirl Polycarbonate Tumblers					
43662	5 oz Swirl PC Tumbler	—	RG36-1	07	36 ea
43663	8 oz Swirl PC Tumbler	DX20029000*	RG36-1	07	36 ea
43664	9 oz Swirl PC Tumbler	—	RG25-1	07	36 ea
43665	10 oz Swirl PC Tumbler	—	RW30-1	07	36 ea
43666	12 oz Swirl PC Tumbler	—	RG25-2	07	36 ea
43668	16 oz Swirl PC Tumbler	—	RW20-1	07	36 ea
43674	22 oz Swirl PC Tumbler	—	RW20-2	07	36 ea
Lafayette Polycarbonate Tumblers					
43633	8 oz Lafayette PC Tumbler	DX20029000*	RG36-1	07	36 ea
43635	10 oz Lafayette PC Tumbler	43635L	RW30-1	07	36 ea
43636	12 oz Lafayette PC Tumbler	43636L	RG25-2	07	36 ea
43637	12 oz Lafayette PC Old Fashioned Tumbler	DX21259000*	RW20	07	36 ea
43638	16 oz Lafayette PC Tumbler	DX21259000*	RW20-1	07	36 ea
43640	22 oz Lafayette PC Tumbler	—	RW20-2	07	36 ea

Note: *The DX Series Disposable Lids listed above are available through the Carlisle | Dinex Catalog

CARAFES & MUGS

Stylish design makes **Cascata** Carafes the most **attractive** carafe you can choose for tabletops and buffets, while offering **convenience** and superior **functionality**.

Cascata Carafe

- Ergonomic shape is easy to hold and angled rim provides a drip-free pour
- Larger sizes can be used for water, juice or wine
- Smaller sizes are good for salad dressings, syrups, single-portion drinks, and snack mix
- A green alternative to single-serve drinks
- Snap-on lids available in solid or hinged styles and fit .5, 1 and 1.5 Liter Carafes
- All sizes have capacity marks for portion control
- Durable polycarbonate looks like glass
- NSF Listed; dishwasher safe



Snap-on lids available in solid or hinged styles



All sizes have capacity marks for portion control



RECOMMENDED GLASS RACK IS LISTED IN THE PRODUCT CHART



2 Cup Carafe

- Durable SAN 11 oz capacity carafe is perfect for room service, hospitals, nursing homes, restaurants, and cafeterias
- Ribbed neck and textured finish provide a better grip and greater safety than glass bottles
- BPA free
- Dishwasher safe



Prod No	Description	Capacity Marks	Glass Rack	Color	Pack
Cascata Carafes & Lids					
70900 Δ	0.25 Liter Carafe	6 oz, 8 oz, 0.25L	RW30-1	07	12 ea
70901 Δ	0.50 Liter Carafe	0.5L	RW20-2	07	12 ea
70902 Δ	1 Liter Carafe	1.0L	RG16-5	07	12 ea
70903 Δ	1.5 Liter Carafe	1.5L	RG9-5	07	12 ea
70904 Δ	Flat Carafe Lid (fits 70901, 70902, 70903)	—	—	02	12 ea
70905 Δ	Hinged Carafe Lid (fits 70901, 70902, 70903)	—	—	02	12 ea
2 Cup Carafe		Disposable Lid			
7000	11 oz Carafe	DX55-57*	RG16-2	07	36 ea

NSF Listed products are designated with a Δ and may be prefixed with an N

Note: *The DX Series Disposable Lids listed above are available through the Carlisle | Dinet Catalog

Lexington™ Polycarbonate Mug

- Heavy-weight mug offers traditional styling in durable polycarbonate
- Crystal clear mug has the look and feel of glass without the replacement
- Recessed drain for easy drying
- Dishwasher safe



43965

Carlisle Mugs

- Made of break-resistant, BPA free Tritan
- Specially designed, large handle allows for easy holding, keeps fingers away from hot liquids
- Available in 6 colors to coordinate with Carlisle's existing dinnerware lines
- Safe for temperatures up to 190°F (88°C)
- Custom decorating available; see pages 330 – 331
- NSF Listed; dishwasher safe



43068

43066



Coffee Mugs

- Rugged, chip- and crack-resistant plastic to give you long-wearing service
- Diablo mugs have double-wall construction to maintain hot temperatures longer
- Diablo II has single-wall construction for money-saving service
- All mugs are dishwasher safe



8004

8104

4512

Customized mugs help promote your company or services. See pages 330 – 331

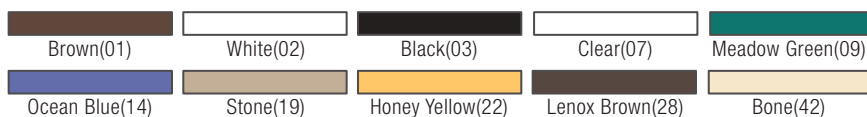

Prod No	Description	Disposable Lid	Glass Rack	Color	Pack
Lexington Polycarbonate Mug					
43965	16 oz Lexington Mug	43965L	RG9-2	07	12 ea
Carlisle Mugs					
43066 Δ	8 oz Carlisle Mug	5109L	RG16-1	02, 03, 09, 14, 22, 42	12 ea
43068 Δ	12 oz Carlisle Mug	—	RG16-1	02, 03, 09, 14, 22, 42	12 ea
Coffee Mugs					
8004	8 oz, 4.13" Diablo Mug with White Liner	—	RG9-1	01, 02	36 ea
8104	8 oz, 4.13" Diablo II Mug	—	RG9-1	01	36 ea
4512	12 oz, 5.5" Jumbo Soup/Latté Mug	—	RTP	19, 28	24 ea

NSF Listed products are designated with a Δ and may be prefixed with an N

Note: *The DX Series Disposable Lids listed above are available through the Carlisle | Dinex Catalog

PITCHERS

Carlisle offers the perfect selection of break-resistant pitchers. **They are an industry favorite.**

VersaPour® Polycarbonate Pitchers

- Lip design allows for easy pouring with ice from front or either side without splashing
- Sure grip ergonomic handle and thumb grip help control pouring
- Made of break-resistant polycarbonate for ultimate durability
- Thinner wall provides optimum strength and durability; reduces wait staff's wrist stress
- 5544 Window Pitcher provides a smooth surface for printing your logo; accommodates up to 2.88" wide by 2" tall image
- Custom decorating available; see pages 330 – 331
- NSF Listed; dishwasher safe

VersaPour's specially contoured lip design allows for easy pouring with ice from front or sides without splashing



Polycarbonate Pitchers

- Ice trap retains ice or beer foam
- Made of break-resistant polycarbonate for ultimate durability
- NSF Listed; dishwasher safe



Prod No	Description	Glass Rack	Color	Pack
VersaPour Polycarbonate Pitchers				
5540 Δ	60 oz VersaPour Pitcher	RF	07, 13	6 ea
5544 Δ	60 oz VersaPour Window Pitcher	RF	07	6 ea
Polycarbonate Pitchers				
5536 Δ	32 oz Polycarbonate Pitcher	RF	07	6 ea
5538 Δ	48 oz Polycarbonate Pitcher	RF	07	6 ea

NSF Listed products are designated with a Δ and may be prefixed with an N

Crystalite® Polycarbonate Pitchers

- Tapered lip permits controlled pouring of the beverage and ice
- Secure thumb hold on handle aids control of pitcher while pouring
- Slot at skirt base deters water collection
- Made of break-resistant polycarbonate for ultimate durability
- NSF Listed; dishwasher safe



Élan™ Polycarbonate Pitcher

- Thick walls and optic bottom gives these pitchers the look of glass
- Made of break-resistant polycarbonate
- Lid available separately
- Dishwasher safe



Clear(07)

Prod No	Description	Glass Rack	Color	Pack
Crystalite Polycarbonate Pitchers				
5583 Δ	48 oz Crystalite Pitcher	RF	07	6 ea
5587 Δ	60 oz Crystalite Pitcher	RF	07	6 ea
Élan Polycarbonate Pitcher & Lid				
5570	58 oz Élan Pitcher	RF	07	6 ea
5573	Clear Lid for Élan Pitcher	—	07	6 ea

NSF Listed products are designated with a Δ and may be prefixed with an N

PITCHERS

Complete the farm-to-table presentation for your guests.

Farm Pitcher

- Durable Tritan is break and craze-resistant
- Stain resistant
- Withstands temperatures from -40° to 180° F
- BPA Free
- Dishwasher safe
- Two-year limited warranty



White(02)



MIN5445

Prod No	Description	Color	Pack
Farm Pitcher			
MIN5445	3 qt Farm Pitcher	02	6 ea

The look of recycled glass, the durability of Tritan plastic.

Mingle

- The look and feel of recycled glass drinkware
- Tritan offers durability that withstands the heavy use in your venue
- Durable Tritan is break and craze-resistant
- Stain resistant
- BPA Free
- NSF Listed; dishwasher safe
- Two-year limited warranty



MIN5443

Coordinating drinkware and bowls listed on pages 38 & 30

White(02) Teal(15) Smoke(18)

Prod No	Description	Color	Pack
Mingle Pitcher			
MIN5443 Δ	74 oz Pitcher	02, 15, 18	4 ea

NSF Listed products are designated with a Δ and may be prefixed with an N

Mid-century modern beauty paired with the durability of Tritan

Epicure Cased

- Gorgeous color is encased between 2 layers of Tritan and won't wear off
- Durable Tritan is break and craze-resistant
- Withstands temperatures from -40°F to 180°F
- Resistant to staining, breaking and chipping
- NSF Listed; dishwasher safe
- BPA free
- Two-year limited warranty



EP30

**Coordinating drinkware
listed on page 38**



Product No	Description	Color	Pack
Epicure Cased Pitcher			
EP30 Δ	74 oz Pitcher w/Lid	02, 15, 18	4 ea

Stainless Steel Pitchers

- The look of silver, with the durability of stainless steel
- 18-8 stainless steel with mirror-polished finish
- Contoured lip to help control flow and prevent drips
- Hollow tubular handle
- Handwashing recommended



609270

Prod No	Description	Glass Rack	Color	Pack
Stainless Steel Pitchers				
609270	2 qt Stainless Steel Bell Pitcher	—	—	1 ea
609273	3 qt Stainless Steel Bell Pitcher	—	—	1 ea

NSF Listed products are designated with a Δ and may be prefixed with an N



DISPOSABLE LIDS

Lids

- Carlisle Disposable Lids are a green solution that saves you money
- Lower your disposable costs when you replace your disposable kid's cups with reusable Carlisle Tumblers and Disposable Lids
- Snug fitting lids fit a variety of Carlisle Tumblers and are slotted for use with straws
- Use for room service applications or anywhere you want to avoid spills
- Lids are packed 1,000 per case



43636L with 4010



In addition to the disposable lids listed here, Carlisle | Dinex offers a large selection of disposable lids for Carlisle and non-Carlisle tumblers. See our Dinex catalog for a complete listing, or contact your local Dinex sales representative for more information.



5812L with
5812



1110L with
1110



1110L
with 43648



5506L with
5506



43635L
with 43635

Translucent(30)

Prod No **Description** **Color** **Pack**

Disposable Lids

5810L	Fits 10 oz Louis Tumbler 5810	30	1 cs
5812L	Fits 12 oz Louis Tumbler 5812	30	1 cs
5822L	Fits 22 oz Louis Tumbler 5822	30	1 cs
5212L	Fits 12 oz Stackable Tumbler 5212, 12 oz Crystalon SAN Tumbler 4012, and 12 oz Crystalon PC Tumbler 4033	30	1 cs
5109L	Fits 9.5 oz Stackable PC Tumbler 5109, 8 oz Carlisle Mug 43066	30	1 cs
5506L	Fits 9.5 oz Stackable Tumbler 5506	30	1 cs
43635L	Fits 10 oz Lafayette Tumbler 43635 and 9.5 oz Crystalon SAN Tumbler 4010	30	1 cs
43636L	Fits 12 oz Lafayette Tumbler 43636	30	1 cs
43965L	Fits 16 oz Lexington Mug 43965	30	1 cs
1112L	Fits 12 oz Bistro Tumbler 1112	30	1 cs
1110L	Fits 10 oz Bistro Tumbler 1110 and 8 oz Lorraine Tumbler 43648	30	1 cs
63910L	Fits 10 oz Cambro® Tumbler NT10	30	1 cs
63912L	Fits 12 oz Cambro® Tumbler NT12	30	1 cs
52412L	Fits 12 oz Cambro® Tumbler LT12	30	1 cs

*Cambro® is a registered trademark of Cambro® Manufacturing Company

**Carlisle is not associated in any way with Cambro® Manufacturing Company



CARLISLE
FOODSERVICE PRODUCTS

PRACTICAL RUGGED STYLISH UNIQUE **TABLETOP ACCESSORIES**



*Set the mood with your tabletop accessories.
Carlisle offers a versatile range of accessories to
complete your tabletop setting in style.*





RAMEKINS

Carlisle has a ramekin for every application. All ramekins are offered in **high-quality melamine** that is dishwasher safe for years to come. **The perfect addition to your hardworking tableware.**

Straight Sided Ramekins

- Melamine ramekins are safe for temperatures up to 212°F
- A modern take on a traditional product
- Use for sauces, condiments, and mini desserts
- Ramekins stack for easy storage and space savings
- NSF Listed; dishwasher safe



Oval Ramekins

- Heavy-weight melamine ramekins are perfect for sauces, condiments, finger foods, mini desserts, etc.
- Oval shape is great for pouring dressings and sauces
- Wide design makes dipping easier
- NSF Listed; dishwasher safe



Square Melamine Ramekins

- Made of sturdy, break-resistant melamine
- 2 oz square ramekins available in single and double sizes
- Ramekins are stackable and can be used as a set for a variety of dipping sauces or individually for soy sauce and other condiments
- Safe for temperatures up to 212°F
- NSF Listed; dishwasher safe



Prod No	Description	Color	Pack
Straight Sided Ramekins			
410 Δ	2 oz Straight Sided Ramekin	02, 03, 42	48 ea
412 Δ	3 oz Straight Sided Ramekin	02, 03, 42	48 ea
414 Δ	4 oz Straight Sided Ramekin	02, 03, 42	48 ea
Oval Ramekins			
S310 Δ	2 oz Oval Ramekin	02, 03, 42	48 ea
S312 Δ	3 oz Oval Ramekin	02, 03, 42	48 ea
S314 Δ	4 oz Oval Ramekin	02, 03, 42	48 ea
Square Melamine Ramekins			
0860 Δ	2 oz Square Ramekin	02, 03	48 ea
0862 Δ	Double 2 oz Square Ramekin	02, 03	24 ea

NSF Listed products are designated with a Δ and may be prefixed with an N



Japanese Style Ramekin

- Made of sturdy, break-resistant melamine
- 2 oz ramekins are styled with an Asian flare
- Heavy-weight design has the look and feel of ceramic or glass
- Ramekins are stackable and can be used for wasabi, ginger, or a variety of dipping sauces
- Safe for temperatures up to 212°F
- NSF Listed; dishwasher safe



Scalloped Melamine Ramekins

- Made of thick-walled, heavy-weight melamine
- Stylish design coordinates with our dinnerware and display pieces
- Serves sauces, butter, salad dressings, salsa, etc.
- NSF Listed; dishwasher safe



Melamine Butter Dish

- Ideal for small portions of butter, wasabi, or other condiments
- Wide mouth gives the illusion of a larger portion
- Heavy-weight sides have the look and feel of ceramic or glass
- Unique look is perfect for both casual and upscale dining or even pre-portioning in buffet and catering applications
- NSF Listed; dishwasher safe



Prod No	Description	Color	Pack
Japanese Style Ramekin			
0864 Δ	2 oz Japanese Style Ramekin	02, 03	48 ea
Scalloped Ramekins			
43942 Δ	1 oz Scalloped Ramekin	02, 03, 42	48 ea
43943 Δ	2 oz Scalloped Ramekin	02, 03, 42	48 ea
43944 Δ	3 oz Scalloped Ramekin	02, 03, 42	48 ea
Melamine Butter Dish			
0855 Δ	1 oz Melamine Butter Dish	02	48 ea

NSF Listed products are designated with a Δ and may be prefixed with an N



RAMEKINS

Melamine Ramekins

- Thick-walled, heavy-weight melamine is perfect for serving sauces, butter, salad dressing, salsa, etc.
- NSF Listed; dishwasher safe



Salsa Dishes

- Carlisle salsa dishes are available in a variety of sizes, weights, and materials
- Designed to accommodate dipping large chips or appetizers
- Deep salsa bowl has 8 oz capacity, perfect for serving salsa, cheese sauce, soups, and other sauces

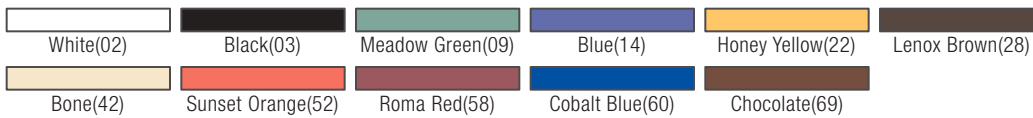

Prod No	Description	Color	Pack
Melamine Ramekins			
S277 Δ	1.75 oz Smooth Ramekin	42	48 ea
S275 Δ	1.5 oz Smooth Ramekin	02, 03, 09, 14, 22, 42, 52, 60	48 ea
0852 Δ	2 oz Smooth Ramekin	02, 03, 09, 14, 22, 42, 52, 58, 60, 69,	72 ea
S280 Δ	3 oz Smooth Ramekin	02, 03, 42, 52, 58, 60, 69	48 ea
S285 Δ	4 oz Smooth Ramekin	02, 03, 09, 14, 22, 42, 52, 58, 60,	48 ea
S286 Δ	6 oz Smooth Ramekin	02, 03, 42, 60, 69	48 ea
S279 Δ	2 oz Fluted Ramekin	02, 03, 42, 60, 69	48 ea
S282 Δ	3 oz Fluted Ramekin	02, 03, 42, 60, 69	48 ea
S287 Δ	4 oz Fluted Ramekin	02, 03, 42, 60, 69	48 ea
Salsa Dishes			
0873 Δ	3 oz Melamine Molcajete Ramekin	03	48 ea
0878 Δ	8 oz Melamine Molcajete Ramekin	03	48 ea
43125	5 oz SAN Salsa Dish	60	48 ea
4553	8 oz Melamine Deep Salsa Bowl	28	36 ea
0875 Δ	5 oz Melamine Salsa Dish	02, 03, 42, 60	48 ea

NSF Listed products are designated with a Δ and may be prefixed with an N

Ramekins & Sauce Cups

- Perfect for individual service of butter, salsa, condiments, sauce
- Made of durable, break-resistant SAN
- Available in four distinct styles
- 0362, 0843, 0844, 0845, 2500: NSF Listed; dishwasher safe



Stainless Steel Ramekin & Sauce Cup

- Rust-free, 18-8 stainless provides durable, easy care service
- Dishwasher safe



SAN Ramekins

- Economical SAN ramekins serve sauces, butter, salad dressings, salsa, etc.
- Stackable design for easier storage
- Dishwasher safe



Prod No	Description	Color	Pack
Ramekins & Sauce Cups			
0362 Δ	2.5 oz Standard Ramekin	02, 07, 28	48 ea
0843 Δ	1 oz Fluted Ramekin	02	48 ea
0844 Δ	2 oz Fluted Ramekin	02, 07	48 ea
0845 Δ	4.5 oz Fluted Ramekin	02, 07, 28	48 ea
2500 Δ	2.5 oz SAN Sauce Cup	07	72 ea
0820	2.75 oz Oyster Sauce Cup	07	144 ea
0338	2 oz Sea Shell Sauce Cup	02	48 ea
0830	1 oz Soufflé Cup	07	144 ea
0831	2.5 oz Soufflé Cup	07	144 ea
602400	1.5 oz Stainless Steel Classic Ramekin	—	144 ea
602500	2.5 oz Stainless Steel Classic Sauce Cup	—	144 ea
SAN Ramekins			
43121	1.5 oz Smooth Ramekin	42	48 ea
43122	2 oz Smooth Ramekin	03	48 ea
43123	3 oz Smooth Ramekin	03, 42	48 ea
43126	6 oz Smooth Ramekin	03, 42, 60	48 ea

NSF Listed products are designated with a Δ and may be prefixed with an N



COFFEE SERVICE

Sugar Caddies

- Merchandiser caddy has pockets for salt and pepper shakers plus sign clip
- NSF Listed; dishwasher safe



Creamer/Pitchers

- Stain-resistant creamers and pitchers can be used for syrup, cream, salad dressings, sauces, etc
- Easy-pour, no-drip lip design
- Made of dishwasher safe SAN; safe for temperatures from 0° to 180°F
- 4560 is NSF Listed



Cheese Shaker/Sugar Pourer

- Popular 12 oz size is made of durable, break-resistant SAN
- Threaded lip fits standard shaker or pourer caps

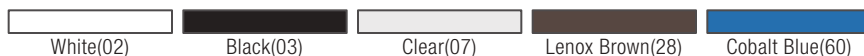

Prod No	Description	Color	Pack
Caddies, Pitchers & Pourers			
4549 Δ	Crystalite Caddy (holds 20 packets)	07	24 ea
4550 Δ	Standard Caddy (holds 20 packets)	02, 03, 07, 28, 60	24 ea
4551 Δ	Merchandiser Caddy (holds 50 packets)	03, 28	24 ea
4552 Δ	Three Compartment Caddy (holds 50 packets)	02	24 ea
4560 Δ	2 oz Syrup Pitcher/Creamer	02, 07	36 ea
4563	3 oz Creamer/Pitcher	02	36 ea
3312	12 oz Base Only	07	72 ea
3316	Base with Pourer Top	07	36 ea
3319	Base with Shaker Top	07	36 ea

NSF Listed products are designated with a Δ and may be prefixed with an N

J-Jars

- Durable jars are ideal for condiments of all types: jelly, jam, mustard, sauces, etc.
- Chrome-plated caddy offers beauty and strength
- NSF Listed



Bud Vases

- Let flowers add the finishing touch to any tabletop
- Beautiful, break-resistant acrylic with heavy base to prevent messy spills



Clear(07)

Prod No	Description	Color	Pack
J-Jars			
4571 Δ	8 oz J-Jar only	07	24 ea
4572 Δ	J-Jar Lid only	07	24 ea
4573	Caddy with 3 J-Jars & Lids	07	1 ea
4575 Δ	8 oz J-Jar with Lid	07	24 ea
Bud Vases			
4650	4" Acrylic Bud Vase	07	12 ea
4651	6" Acrylic Bud Vase	07	12 ea

NSF Listed products are designated with a Δ and may be prefixed with an N



SERVING BASKETS

Woven Baskets

- Handmade natural beauty combined with easy care
- Resistant to mold and mildew
- Microwave safe
- Dishwasher safe



Munchie Baskets™

- Excellent for serving a deli sandwich or a specialty appetizer
- Stackable and dishwasher safe
- Custom imprinting available; see pages 330-331 for more information



The industry's only basket with custom imprinting

Basket Server

- Break-resistant SAN baskets can be used for holding tall items like bread sticks or can be used as an ice bucket for table or room service
- Safe for use in temperatures from 0° to 180°F
- Dishwasher safe

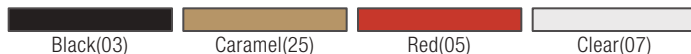

Prod No	Description	Color	Pack
Woven Baskets			
6550	9" x 6.25" Small Oval Basket	03, 25	6 ea
6551	11.75" x 7.75" Medium Oval Basket	03, 25	6 ea
6552	11.5" x 8.5" Rectangle Oval Basket	03, 25	6 ea
6553	9" Small Round Basket	03, 25	6 ea
6555	11" Medium Round Basket	03, 25	6 ea
Munchie Baskets			
44030	7.38" x 5.38" Munchie Basket	03, 05	24 ea
44031	10.38" x 8" Munchie Basket	03, 05	12 ea
Basket Server			
356	6.5" Basket, 3 qt	07	6 ea



WeaveWear™ Baskets & Platter

- For serving chips, fries, sandwiches, finger foods, or kids' meals
- Wicker weave pattern exterior with smooth, easy to clean interior
- Safe alternative to wicker and plastic coated wire
- Made of durable FDA grade polypropylene
- Vented base on 6528 and 6529 allows for drainage and reduces condensation
- 6528, 6527, 6529 feature a wide diameter and raised bottom design to create a unique presentation for your signature sandwich, appetizer, or specialty item
- Dishwasher safe



Wicker Look Basket

- Elegant baskets for serving chips, fries, sandwiches, finger foods, or kids' meals
- Design features a detailed wicker weave patterned exterior
- Smooth, easy-to-clean interior
- Made of durable, scratch-resistant polycarbonate



Bread & Bun Basket

- Extremely economical basket is great for all types of food such as sandwiches, fries, ribs, chips, or breads



Prod No	Description	Color	Pack
<div style="display: flex; justify-content: space-around; font-size: small;"> Brown(01) Black(03) Red(05) Clear(07) Green(09) Light Brown(31) Straw(67) </div>			
WeaveWear Baskets & Platter			
6504	9" x 6.25" Oval WeaveWear Basket	01, 03, 05, 09, 67	12 ea
6524	9" Round WeaveWear Basket	01, 03, 05, 09, 67	12 ea
6526	12" Round WeaveWear Basket	01, 03, 05, 09, 67	12 ea
6528	9.25" Round WeaveWear Basket with Drain Slots	03	12 ea
6527	10.38" Round WeaveWear Platter	03, 31	12 ea
6529	11" Round WeaveWear Basket with Drain Slots	03	12 ea
Wicker Look Basket			
WB965	9.44" x 6.63" Oval Basket	07	6 ea
Bread & Bun Basket			
0333	9.25" x 6" Oval Basket	03, 05	36 ea



TORTILLA SERVERS

Interlocking base & lid design allows for stacking several tortilla servers at one time

Tortilla Servers

- Lid has easy-grip, recessed handle
- Durable polycarbonate tortilla servers withstand temperatures up to 212°F
- Polypropylene servers are easy-clean, long-lasting, and economical; withstand temperatures up to 190°F
- NSF Listed; dishwasher safe

US Patent No. D-331351



Salsa and Molcajete Dishes on page 58

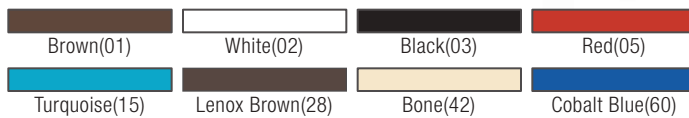

Prod No	Description	Color	Pack
Interlocking Tortilla Servers & Lids			
0470 Δ	7.5" PC Tortilla Server	01, 02, 03, 05, 15, 60	24 ea
0475 Δ	7.5" PPY Tortilla Server	03, 05, 28, 42	24 ea

NSF Listed products are designated with a Δ and may be prefixed with an N

Aztec Tortilla Servers

- Unique Aztec design works well in any traditional Mexican or Tex-Mex restaurant
- 8" and 12" servers available in a lift off lid model
- 7" server available with hinged lid for easy one handed access
- Thick walled polypropylene material helps keep tortillas warm for table service
- Microwaveable, safe for temperatures up to 190°F
- Servers are stackable
- NSF Listed; dishwasher safe



Prod No	Description	Color	Pack
Aztec Tortilla Servers & Lids			
0710 Δ	7" Hinged Tortilla Server	03, 29	12 ea
0713 Δ	8" Lift Off Tortilla Server	03, 29	12 ea
0717 Δ	12" Lift Off Tortilla Server	03, 08, 29	6 ea
0700 Δ	7" Hinged Replacement Lid	03, 29	12 ea
0703 Δ	8" Replacement Lid	03, 08, 14, 29	12 ea
0707 Δ	12" Replacement Lid	03, 08, 14, 29	6 ea

NSF Listed products are designated with a Δ and may be prefixed with an N



SERVING TRAYS & ACCESSORIES

Round Serving Trays

- Serving Trays are perfect for bar service or individual meals including salads, sandwiches, or burgers
- Perfect size for iced seafood platters
- Made of heavy-duty, break-resistant melamine
- NSF Listed; dishwasher safe



1300



44532

Roll-Top Covered Dishes

- Multi-purpose roll-top dishes are perfect for serving sugar, candies, sauces, or dressings
- High-polish 18-8 stainless steel
- Handwashing recommended



609132

609131

609133



Prod No	Description	Color	Pack
Serving Trays			
44532 Δ	11.5" Round Melamine Serving Tray	03	12 ea
1300 Δ	13" x 1.5" Melamine Serving Tray	01, 02, 60	12 ea
Roll-Top Covered Dishes			
609131	10 oz Roll-Top Covered Dish	—	12 ea
609132	14 oz Roll-Top Covered Dish	—	12 ea
609133	30 oz Roll-Top Covered Dish	—	1 ea

NSF Listed products are designated with a Δ and may be prefixed with an N



Allegro™ Number Stands

- Use taller card holders to identify banquet seating or reserved tables and shorter holders for place cards or on buffet lines
- Heavy-weight base prevents accidental tipping
- 18-10 mirror polish finish



Dual Booster Seats

- Two-sided seat offers a choice of heights
- Extra-strong, one-piece molded design with wide square base for better stability
- Anti-skid pads on both sides prevent sliding

Booster Seat With Safety Strap

- Strap secures to chair to increase child safety
- Snap clasp and adjustable strap for use behind chair back or under seat



Prod No	Description	Color	Pack
Number Stands			
609179	4" Allegro Number Stand	—	6 ea
609183	8" Allegro Number Stand	—	6 ea
Dual Booster Seat			
7110	Booster Seat	01, 03, 05, 06, 08	4 ea
Booster Seat with Safety Strap			
7111-4	Booster Seat with Safety Strap	01, 03, 05, 06	4 ea
Replacement strap			
7112	Replacement Strap	03	12 ea

Note: 7110, 7111-4 can ship UPS/FedEx Ground at oversize cost



CARLISLE
FOODSERVICE PRODUCTS

BEAUTIFUL
QUALITY
ELEGANT
PROTECTIVE
HANDMADE
MARKO
TABLE
COVERINGS

No room is complete without the finishing touches and setting. An excellent table begins with quality products. Marko offers the finest quality of textiles to help you achieve that perfect look.



IN-STOCK PROGRAM

Carlisle FoodService is pleased to announce the Marko In-Stock Program. For the very first time, **the most requested Marko table coverings, napkins, skirting and accessories are now available as stocked items.** No longer will you have to place a separate order for your most sought after Marko items. With Carlisle FoodService, **you can count on Marko** to be there for you.

Ordering Information:

- In-Stock items can be combined on one purchase order with foodservice products
- In-Stock items can be combined with made-to-measure items
- Combined orders of In-Stock items and made-to-measure items will ship together upon completion of the made-to-measure items

Note:

- Made-to-measure items cannot be combined with foodservice orders

This is just the beginning—additional items will be added based on demand.

For more information please contact your sales representative.



Fabric

SoftWeave

A smooth luxurious feel and a natural, soft texture between your fingers. Marko SoftWeave table linens and napkins, made of spun filament polyester, deliver the soft feel of cotton, yet don't lint, pill, shrink, or fade like cotton. Thanks to an advanced finishing technology, our SoftWeave is able to remain elegant and soft to the touch longer than spun or 50/50 blended polyester. SoftWeave combines style and sophistication with the performance features and low cost efficiencies you desire. Our advanced stain release technology allows you to wash at a low 120°F rather than 160°F while using half the detergent, dramatically lowering your energy costs.

Perennial Classics

Our Perennial Classics line offers an easy way to buy ready-made linens at an economical price. The tablecloths and napkins are hefty and are made from soft, absorbent, spun polyester to resist shrinking and fading.

Napkins

Napkins offered in both our SoftWeave and Perennial Classic lines can be used to turn an ordinary dinner, or a "quick bite to eat" into a memorable meal or night on the town. Using cloth napkins can keep your customers coming back for more and for less than you think.



SoftWeave Square



SoftWeave Round



Classic Twill Skirting w/ SoftWeave Tablecloth



SoftWeave Napkins

Aspen Damask Color - Marko Exclusive



White(010)



Black(014)



Burgundy(046)



Sage(147)

SoftWeave Fabric Tablecloths

53785252SM	SoftWeave Tablecloth	52" x 52"	010, 014, 046	1 ea
537852AITM	SoftWeave Tablecloth	52" x 108"	010	1 ea
53785454SM	SoftWeave Tablecloth	54" x 54"	010	1 ea
537854AUTM	SoftWeave Tablecloth	54 x 120"	010	1 ea
53785858SM	SoftWeave Tablecloth	58" x 58"	010	1 ea
53787272SM	SoftWeave Tablecloth	72" x 72"	010	1 ea
537876RM	SoftWeave Tablecloth	76" Round	010	1 ea
537890RM	SoftWeave Tablecloth	90" Round	010	1 ea
53935252SM	SoftWeave Aspen Damask Tablecloth	52" x 52"	147	1 ea

SoftWeave Fabric Napkins

53781717NM	SoftWeave Napkins	17" x 17"	010, 014, 046	12 ea
53782020NM	SoftWeave Napkins	20" x 20"	010, 014, 046	12 ea
53931717NM	SoftWeave Aspen Damask Napkins	17" x 17"	147	12 ea
53932020NM	SoftWeave Aspen Damask Napkins	20" x 20"	147	12 ea

Perennial Classic Tablecloths

53585252SH	Perennial Classics Tablecloth	52" x 52"	010	6 ea
535890RH	Perennial Classics Tablecloth	90" Round	010	6 ea

Perennial Classic Napkin

53582020NH	Perennial Classics Napkins	20" x 20"	010, 014, 046	72 ea
------------	----------------------------	-----------	---------------	-------



Fabric

SoftWeave™ Bistro Striped Napkins

Marko's Bistro Striped Napkins have all the practical features you expect of SoftWeave™ with a trend-right, farm to table style. These napkins are low-maintenance. Designed to be machine washed, colors won't fade or bleed even when washed with bleach. Easy soil release and minimal shrinkage makes these napkins a perfect choice for casual dining.



Make your table on-trend with Bistro Striped Napkins.



Epicure Tone on Tone Napkins

Set the mood with classic tone on tone striped napkins. Epicure Napkins bring an upscale look to your table with their elegant feel and popular striped style. These napkins are made of familiar SoftWeave fabric that offers a soft feel, great soil release and minimal linting.



Five popular colors lets you set a table with classic elegance.



SoftWeave Bistro Striped Napkins

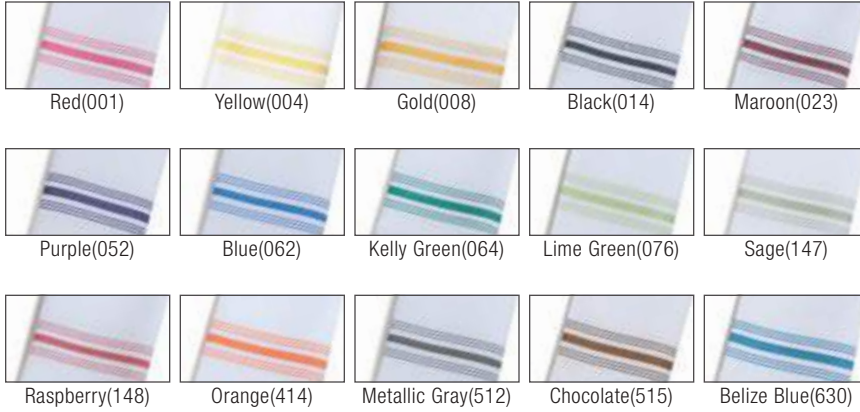

Epicure Tone on Tone Napkins



SoftWeave Bistro Striped Napkins

53771822NH001	SoftWeave Bistro Striped Napkin	18" x 22"	Red	12 ea
53771822NH004	SoftWeave Bistro Striped Napkin	18" x 22"	Yellow	12 ea
53771822NH008	SoftWeave Bistro Striped Napkin	18" x 22"	Gold	12 ea
53771822NH014	SoftWeave Bistro Striped Napkin	18" x 22"	Black	12 ea
53771822NH023	SoftWeave Bistro Striped Napkin	18" x 22"	Maroon	12 ea
53771822NH052	SoftWeave Bistro Striped Napkin	18" x 22"	Purple	12 ea
53771822NH062	SoftWeave Bistro Striped Napkin	18" x 22"	Blue	12 ea
53771822NH064	SoftWeave Bistro Striped Napkin	18" x 22"	Kelly Green	12 ea
53771822NH076	SoftWeave Bistro Striped Napkin	18" x 22"	Lime Green	12 ea
53771822NH147	SoftWeave Bistro Striped Napkin	18" x 22"	Sage	12 ea
53771822NH148	SoftWeave Bistro Striped Napkin	18" x 22"	Raspberry	12 ea
53771822NH414	SoftWeave Bistro Striped Napkin	18" x 22"	Orange	12 ea
53771822NH512	SoftWeave Bistro Striped Napkin	18" x 22"	Metallic Gray	12 ea
53771822NH515	SoftWeave Bistro Striped Napkin	18" x 22"	Chocolate	12 ea
53771822NH630	SoftWeave Bistro Striped Napkin	18" x 22"	Belize Blue	12 ea

Epicure Tone on Tone Napkins

53761822NH001	SoftWeave Tone On Tone Striped Napkin	18" x 22"	Red	12 ea
53761822NH010	SoftWeave Tone On Tone Striped Napkin	18" x 22"	White	12 ea
53761822NH014	SoftWeave Tone On Tone Striped Napkin	18" x 22"	Black	12 ea
53761822NH512	SoftWeave Tone On Tone Striped Napkin	18" x 22"	Gray	12 ea
53761822NH515	SoftWeave Tone On Tone Striped Napkin	18" x 22"	Chocolate	12 ea

Vinyls

Whether you are looking for the classic checkered vinyl or a new upscale pattern to complete your dining room look, Marko's vinyl has that and everything in between including the elegance and drape of fabric.



Classic™ Series (Red Check)

Skirting

From banquets, weddings, and buffet lines to meetings, conferences and registration tables, the use for table skirting is limitless. Our TruFinish™ Classic™ Twill skirting, made from 100% filament polyester doesn't fade and resists wrinkles for an elegant presentation.

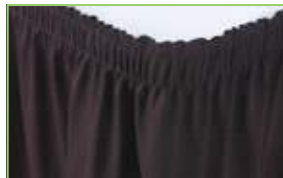

Classic Twill Black

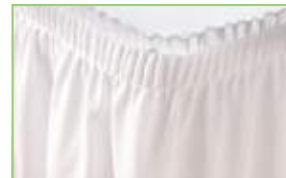

Classic Twill White



Add Some Sparkle To Your Table Top With Glimmer

Combine Glimmer or one of our other vinyls with traditional table skirting to get the best of both worlds. Vinyls provide an easy wipe off surface for quick spill clean up. Traditional fabric skirting adds the soft touch – perfect for weddings, receptions, buffets, or other special events.

Classic Twill

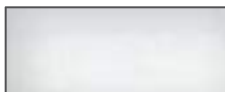

White(010)



Black(014)

Classic Check



Red(001)

Expression Trellis



Coppertone(012)

Vative Rove



Stone(382)

Vative Glimmer



Metallic Silver(625)

Vinyl Tablecloths

51515252SM001	Classic Series - Classic Check	52" x 52"	Red	1 ea
57285252SM012	Expression Series - Trellis	52" x 52"	Coppertone	1 ea
59035252SM382	Vative Series - Rove	52" x 52"	Stone	1 ea
59085252SM625	Vative Series - Glimmer	52" x 52"	Metallic Silver	1 ea

Fabric Skirting

5024CE29AF010	Classic Twill Shirred Pleat Skirting w/Velcro Header & 24 Clips	13'	White	1 ea
5024CE29AF014	Classic Twill Shirred Pleat Skirting w/Velcro Header & 24 Clips	13'	Black	1 ea
5024EG29AF010	Classic Twill Shirred Pleat Skirting w/Velcro Header & 31 Clips	17.5'	White	1 ea
5024EG29AF014	Classic Twill Shirred Pleat Skirting w/Velcro Header & 31 Clips	17.5'	Black	1 ea
5024FW29AF010	Classic Twill Shirred Pleat Skirting w/Velcro Header & 38 Clips	21'	White	1 ea
5024FW29AF014	Classic Twill Shirred Pleat Skirting w/Velcro Header & 38 Clips	21'	Black	1 ea

Clips

Marko offers specifically designed clips to fit a variety of table edges. From our lifetime guarantee on our metal clips to our polycarbonate plastic clips, Marko has everything you need to pull your look together.

Overlock & Valance
5CC55PC-12



Metal
5CC118MP-12



Metal
5CC120MP-12



Plastic
5CC200PC-12



Plastic
5CCCCLIP-12



Plastic
5CCLCLIP-12



Accessories

5CC55PC-12	Overlock & Valance Clip, Hook & Loop Header
5CC118MP-12	Metal Skirting Clip, Hook & Loop Header
5CC120MP-12	Metal Skirting Clip, Hook & Loop Header
5CC200PC-12	Plastic Skirting Clip, Hook & Loop Header
5CCCCLIP-12	Plastic Skirting Clip, Hook & Loop Header
5CCLCLIP-12	Large Plastic Skirting Clip, Hook & Loop Header

Table Edge

1/2"	12 ea
3/8" - 1-1/4"	12 ea
1-1/4" - 2-1/4"	12 ea
3/8" - 3/4"	12 ea
3/4" - 2"	12 ea
1-1/2" - 2-1/2"	12 ea



STYLISH BREAK- RESISTANT CONTEMPO- RARY ELEGANT **DISPLAYWARE**

How you display your culinary creations is what brings your guests in. Carlisle has everything you need to provide an organized, attractive, and safe food service environment.



MELAMINE DISPLAYWARE

Balsam display ware is your **Eco-friendly** choice for displaying your prepared food in front of your guest. This displayware is made from **50% sustainable natural resources** vs. 20% in standard melamine, making Balsam **one of the most environmentally friendly commercial grade melamines on the market.**



Balsam™

- Withstands the rigors of commercial foodservice dishwasher use
- Maintains its appearance after one year of dishwasher testing
- Durable melamine is stain, scratch- and break-resistant, making it ideal for any foodservice operation
- Safe for temperatures up to 212°F
- NSF Listed; dishwasher safe



Bavarian Cream(37)

Prod No	Description	Color	Pack
Balsam Displayware			
55520 ▲	1" Deep Full Size Pan	37	6 ea
55522 ▲	2.5" Deep Full Size Pan	37	6 ea
55524 ▲	4" Deep Full Size Pan	37	6 ea
55526 ▲	1" Deep Half Long Size Pan	37	6 ea
55528 ▲	2.5" Deep Half Long Size Pan	37	6 ea
55530 ▲	4" Deep Half Long Size Pan	37	6 ea
55532 ▲	1" Deep Half Size Pan	37	6 ea
55534 ▲	2.5" Deep Half Size Pan	37	6 ea
55536 ▲	4" Deep Half Size Pan	37	6 ea
55538 ▲	1" Deep Third Size Pan	37	6 ea
55540 ▲	2.5" Deep Third Size Pan	37	6 ea
55542 ▲	4" Deep Third Size Pan	37	6 ea
55544 ▲	26 oz Angled Bowl	37	6 ea
55546 ▲	3 qt Angled Bowl	37	6 ea
55550 ▲	26 oz Square Bowl	37	6 ea

NSF Listed products are designated with a ▲ and may be prefixed with an N

Customers respond to the presentation of prepared food. **Make your presentation irresistible** with our Flared bowls. The shape and flare **draw the eye into the food inside.**

Flared Square Bowls

- Large display bowls coordinate with many other Carlisle pieces
- High quality, heavy-weight melamine
- Safe for temperatures up to 212°F
- NSF Listed; dishwasher safe



Prod No	Description	Color	Pack
Flared Square Bowls			
33360 Δ	5 qt, 11.75" Small Flared Bowl	02, 03	4 ea
33362 Δ	8 qt, 13.75" Medium Flared Bowl	02, 03	4 ea
33364 Δ	15.5 qt, 16.88" Large Flared Bowl	02, 03	4 ea

NSF Listed products are designated with a Δ and may be prefixed with an N

MELAMINE DISPLAYWARE

The **contemporary design of Rave is the versatile choice for your displays.** Rave suits many types of cuisine and the interesting shapes create a playful display that will **draw guests to your culinary offerings.**

Rave®

- Offers the look and feel of china without the replacement cost
- Bowls lock into pedestal for secure serving
- Skid-resistant feet
- Safe for temperatures up to 212°F
- Dishwasher safe



Prod No	Description	Color	Pack
Rave Displayware			
33310	7", 1.5 qt Rave Serving Bowl	02, 03	6 ea
33312	10", 4.5 qt Rave Serving Bowl	02, 03	6 ea
33314	12", 4.5 qt Rave Salad Bowl	02, 03	6 ea
33316	13", 2 qt Rave Starburst Bowl	02, 03	6 ea
33318	15" Rave Bowl with Rim	02, 03	6 ea
33320	10", 2.5 qt Rave Rectangular Platter	02, 03	6 ea
33322	16" Rave Rectangular Platter	02, 03	6 ea
33324	23" Rave Rectangular Platter	02, 03	6 ea
33326	16" Rave Trapezoid Platter	02, 03	6 ea
33302	4" Rave Pedestal	02, 03	12 ea

NSF Listed products are designated with a **▲** and may be prefixed with an N

The oversized scalloped platters are **perfect for display, deli and tabletop presentations**. This collection **easily coordinates with many other Carlisle pieces**.

Scalloped Platters

- High quality, heavy-weight melamine
- Safe for temperatures up to 212°F
- NSF Listed; dishwasher safe



Terra is a longtime Carlisle customer favorite! The **organic design and exceptional quality** make it popular for buffet and display case use.

Terra®

- Unique textured platters add depth
- Safe for temperatures up to 212°F
- NSF Listed; dishwasher safe



Prod No	Description	Color	Pack
Scalloped Platters			
7924 Δ	14.5" Square Small Scalloped Tray	02, 03	4 ea
7926 Δ	16.81" Square Medium Scalloped Tray	02, 03	4 ea
7928 Δ	18.81" Square Large Scalloped Tray	02, 03	4 ea
7944 Δ	19.5" x 13" Rectangular Small Scalloped Tray	02, 03	4 ea
7946 Δ	22.5" x 14.5" Rectangular Medium Scalloped Tray	02, 03	4 ea
7948 Δ	24.5" x 18.5" Rectangular Large Scalloped Tray	02, 03	4 ea
Terra Displayware			
44514 Δ	14" Round Textured Platter	02, 03	12 ea
44518 Δ	18" Round Textured Platter	02, 03	12 ea
44520 Δ	13.5" x 9.25" Rectangular Textured Platter	02, 03	4 ea
44522 Δ	15.5" x 11" Rectangular Textured Platter	02, 03	4 ea
44524 Δ	18" x 12.5" Rectangular Textured Platter	02, 03	4 ea

NSF Listed products are designated with a Δ and may be prefixed with an N

MELAMINE DISPLAYWARE

The Palette Designer series is our **lighter weight melamine** displayware and is **perfect for large food presentations**. We offer a **wide rim style that frames your food beautifully**.

Palette Designer Displayware®

- Combine with decorated Palette pieces for attention getting displays in the deli case or buffet line
- Break-resistant construction reduces replacement costs
- High quality, heavy-weight melamine
- Safe for temperatures up to 212°F
- NSF Listed; dishwasher safe

Wide Rim

- Use with displayware covers shown on the facing page



Prod No	Description	Cover	Color	Pack
Palette Designer Displayware				
43024 Δ	12" Wide Rim Round Plate	1994*	02	12 ea
44400 Δ	12" Wide Rim Square Plate	44400C	02, 03	4 ea
44402 Δ	14", 4.5 qt Wide Rim Square Bowl	44402C	02, 03	4 ea
44404 Δ	15" Wide Rim Round Platter	44404C	02, 03	4 ea
44406 Δ	19" Wide Rim Round Platter	—	02, 03	4 ea
44410 Δ	17" X 13" Wide Rim Oval Platter	44410C	02, 03	4 ea
44412 Δ	21" X 15" Wide Rim Oval Platter	44412C	02, 03	4 ea
44414 Δ	14" X 10" Wide Rim Rectangle Platter	44414C	02, 03	4 ea
44416 Δ	17" X 13" Wide Rim Rectangle Platter	44416C	02, 03	4 ea
44418 Δ	22" Wide Rim Salmon Platter	44418C	02, 03	4 ea

NSF Listed products are designated with a Δ and may be prefixed with an N
 *1994 Plate Cover can be found in the Dinnerware section of this catalog

Food Pans

- 2.5" and 4" deep pans can be turned over and used as display stands
- Combine with display covers shown on the facing page to create an attractive merchandising display
- NSF Listed; dishwasher safe



Palette Displayware Covers

- Designed to work with selected pieces of our Palette Displayware
- Clear polycarbonate covers are highly heat- and break-resistant
- Allows you to safely protect and transport dishes prepped in advance
- Stack for compact storage
- Dishwasher safe



Prod No	Description	Cover	Color	Pack
Palette Designer Displayware Food Pans				
44420 Δ	1" D Full Size Food Pan, 20.75" x 12.75"	44422C	02, 03	6 ea
44422 Δ	2.5" D Full Size Food Pan, 20.75" x 12.75"	44422C	02, 03	6 ea
44430 Δ	1" D Half Size Food Pan, 12.75" x 10.38"	44432C	02, 03	6 ea
44432 Δ	2.5" D Half Size Food Pan, 12.75" x 10.38"	44432C	02, 03	6 ea
44460 Δ	1" D Third Size Food Pan, 12.75" x 6.87"	44462C	02, 03	6 ea
44462 Δ	2.5" D Third Size Food Pan, 12.75" x 6.87"	44462C	02	6 ea
Palette Designer Displayware Covers				
44400C	Cover for 12" Wide Rim Square Plate	—	07	12 ea
44402C	Cover for 14" Wide Rim Square Platter	—	07	12 ea
44410C	Cover for 17" x 13" Wide Rim Oval Platter	—	07	12 ea
44414C	Cover for 14" x 10" Wide Rim Rectangle Platter	—	07	12 ea
44416C	Cover for 17" x 13" Wide Rim Rectangle Platter	—	07	12 ea
44418C	Cover for 22" Wide Rim Salmon Platter	—	07	12 ea
44422C	Cover for Full Size Food Pan	—	07	12 ea
44432C	Cover for Half Size Food Pan	—	07	12 ea
44462C	Cover for Third Size Food Pan	—	07	12 ea

NSF Listed products are designated with a Δ and may be prefixed with an N

MELAMINE DISPLAYWARE

These 6 versatile pieces coordinate beautifully with our **Epicure Dinnerware** pieces that are offered **on page 25**

Epicure® Displayware

- Stain- and scratch-resistant finish
- Made of dependable, impact-resistant melamine
- Safe for temperatures up to 212°F
- NSF Listed; dishwasher safe



Narrow rimmed platters provide a larger landscape for your food presentations. Carlisle offers **5 shapes and sizes** to give you the perfect size for your application.

Narrow Rimmed Displayware

- Rimmed style displayware in a variety of shapes
- Stain- and scratch-resistant finish
- Made of dependable, impact-resistant melamine
- Safe for temperatures up to 212°F
- NSF Listed; dishwasher safe



Prod No	Description	Color	Pack
Epicure Displayware			
ARR240 ▲	46 oz, 9" Round Open Vegetable Bowl	02	12 ea
5933 ▲	32 oz, 8.25" Round Bowl	02	24 ea
43737 ▲	24 oz, 7.38" Footed Serving Bowl	02, 03	12 ea
43738 ▲	36 oz, 8.63" Footed Serving Bowl	02	12 ea
43739 ▲	57 oz, 9.25" Footed Serving Bowl	02	12 ea
43842 ▲	14" x 10" Oblong Platter	02, 03	12 ea
Narrow Rimmed Displayware			
ARR112 ▲	14.75" x 10.5" Oval Platter	02	12 ea
ARR120 ▲	12" x 8.5" Oval Platter	02, 25	12 ea
43745 ▲	28 oz, 10" x 7.5" Baker/Server	02, 25	12 ea
43840 ▲	21" x 15" Catering Platter	02, 03	6 ea
43772 ▲	15.5" x 10.5" Oblong Platter	02	12 ea

NSF Listed products are designated with a ▲ and may be prefixed with an N

Salad Bowl

- Made of dependable, impact-resistant melamine
- Safe for temperatures up to 212°F
- NSF Listed; dishwasher safe



1250B shown
with 7901

1000B

Scalloped DeliWare® & Inset

- Low profile reduces food waste without sacrificing presentation
- 5.5" Square Scalloped Dish is designed to use alone or as an inset in the 18" x 7" Scalloped Platter (7932)
- Use the combination of our inset and platter for displaying foods with toppings or sauces
- Durable melamine material
- NSF Listed; dishwasher safe



7930

7934

7932



Prod No	Description	Color	Pack
Melamine Salad Bowls			
1000B Δ	1.9 qt, 10" Bowl	03	6 ea
1250B Δ	3.7 qt, 12" Bowl	03	6 ea
Scalloped DeliWare & Inset			
7930 Δ	14" x 10" Scalloped Baker	03	4 ea
7932 Δ	18" x 7" Scalloped Platter	03	4 ea
7934 Δ	5.5" Square Scalloped Dish/Inset	03	48 ea

NSF Listed products are designated with a Δ and may be prefixed with an N



DISPLAYWARE

The look of Acacia Wood **without the need to hand wash and season.**

Epicure® Acacia Wood Grain

- An assortment of sizes and shapes, something for every type of food and venue
- A size to fit every serving need from dip bowls to 18" round platters
- Safe for temperatures up to 212°F
- Stain resistant*
- NSF Listed; dishwasher safe
- Two-year limited warranty



EAG09 Flight Tray & EAG08 Dip Bowls



The Carlisle
TABLETOP
COLLECTION



 Brown(69)

Prod No	Description	Color	Pack
Epicure Acacia Wood Grain Displayware			
EAG01 Δ	7.5", 34 oz Small Bowl	69	12 ea
EAG02 Δ	12", 4.8 qt Serving Bowl	69	6 ea
EAG04 Δ	18" x 15" Oval Platter	69	6 ea
EAG05 Δ	13.88" x 7.75" Rectangular Tray	69	12 ea
EAG06 Δ	18" Round Platter	69	6 ea
EAG07 Δ	14.75" x 6.75" Rectangular Tray	69	12 ea
EAG08 Δ	4.38", 5 oz Dip Bowl	69	12 ea
EAG09 Δ	13.19" Flight Tray	69	6 ea
EAG10 Δ	19.25" Round Platter	69	2 ea
EAG11 Δ	9" Square Tray	69	12 ea

NSF Listed products are designated with a Δ and may be prefixed with an N

The perfect pieces for **versatile displays**
and any color combinations.

Terra® Deliware

- Durable Tritan serving pieces will stand the test of time in service
- Durable Tritan is break and craze-resistant
- Stain resistant
- NSF Listed; dishwasher safe
- BPA Free
- Two-year limited warranty



Prod No	Description	Color	Pack
Terra Deliware			
TRA01 Δ	19.75" x 14.75" Large Rectangular Tray	18	6 ea
TRA02 Δ	12.38", 3.4 qt Square Bowl	18	12 ea
TRA03 Δ	12.63" x 8.5" Rectangular Platter	18	12 ea
TRA04 Δ	6.5", 37 oz Ruffle Bowl	18	24 ea
TRA05 Δ	7", 28 oz Ruffle Bowl	18	24 ea
TRA06 Δ	14.5" Round Tray	18	12 ea
TRA07 Δ	15" x 5" x 3" Smoke 3-section Server	18	12 ea
TRA08 Δ	11" Ruffle Dinner Plate	18	12 ea
TRA09 Δ	8" Ruffle Salad Plate	18	12 ea
TRA10 Δ	19.5" x 11" Ruffle Oval Platter	18	6 ea
TRA11 Δ	15.25", 7.4 qt Serving Bowl	18	6 ea
TRA12	13.25" Ruffle Serving Tray	18	12 ea

NSF Listed products are designated with a Δ and may be prefixed with an N

DISPLAYWARE

Designer Displayware®

- Heavy, china/ceramic feel and look without the breakage
- Perfect for salads and entrées in family style dining, banquets, buffets, or deli display cases
- Select pieces available in unique two-tone Mosaic colors
- FDA approved material
- Safe for temperatures up to 212°F
- NSF Listed; dishwasher safe



Prod No	Description	Color	Pack
Designer Displayware			
7910 Δ	5 lb, 10.5" Designer Pasta Bowl	02, 03	4 ea
7913 Δ	10 lb, 13" Designer Pasta Bowl	02, 03	4 ea
7914 Δ	2 qt, 14" x 10" Oval Designer Platter	02, 03	4 ea
7916 Δ	3 qt, 16" x 12" Oval Designer Platter	02, 03	4 ea
7918 Δ	4 qt, 19" x 13.75" Oval Designer Platter	02, 03	4 ea
7919 Δ	2.9 qt, 9" x 12" Designer Baker	02, 03	4 ea
7920 Δ	4 qt, 10" x 14" Designer Baker	02, 03	4 ea
Mosaic Designer Displayware			
8910 Δ	5 lb, 10.5" Mosaic Pasta Bowl	406	4 ea
8919 Δ	2.9 qt, 9" x 12" Mosaic Baker	406	4 ea
8920 Δ	4 qt, 10" x 14" Mosaic Baker	406	4 ea

NSF Listed products are designated with a Δ and may be prefixed with an N

Elevate your creations! Carlisle plate stands are available in 2 sizes and 2 colors and **work well with the pieces listed below.**

Plate Stands

- High quality, heavy-weight melamine
- Two height choices add dimension to deli cases or buffets
- Use with a variety of plates and platters including 43024, 44404, and 44406
- NSF Listed; dishwasher safe



Scoop Bowl

- 4 qt bowls are perfect for buffets or salad bar
- Durable SAN plastic is resistant to food oils and acids
- For use in temperatures from 0° to 180°F
- Dishwasher safe



Prod No	Description	Color	Pack
Plate Stands			
7900 Δ	2.75" H Plate Stand	02, 03	4 ea
7901 Δ	4" H Plate Stand	02, 03	4 ea
Scoop Bowl			
0411	4 qt, 13.75" x 9.38" Scoop Bowl	02, 03	4 ea

NSF Listed products are designated with a Δ and may be prefixed with an N



DISPLAYWARE

Tulip Deli® Crocks & Platter

- Beautiful swirl pattern and high gloss finish
- Crocks and platters nest for easy storage
- Durable SAN plastic is resistant to food oils and acids
- Safe for use in temperatures from 0° to 180°F
- Dishwasher safe



Orchid® Deli Bowls

- Polycarbonate bowls and crocks have a beautiful, glass-like appearance without the breakage
- Extremely break-resistant material can be used in heated cases or on hot tiles up to 212°F
- Withstands exposure to food acids
- NSF Listed; dishwasher safe



Prod No	Description	Color	Pack
Tulip Deli Crocks & Platter			
6963	5 lb, 10.38" x 6.75" Tulip Deli Crock	02, 03, 05	6 ea
6966	10 lb, 13" x 10.38" Tulip Deli Crock	02, 03, 05	6 ea
Orchid Deli Bowls			
6531 Δ	1.5 qt, 8" Orchid Deli Bowl	03	12 ea
6532 Δ	3 qt, 10" Orchid Deli Bowl	03	12 ea
6534 Δ	7 qt, 12" Orchid Deli Bowl	03	12 ea

NSF Listed products are designated with a Δ and may be prefixed with an N

Octagon Bowls

- Contemporary octagonal shape is ideal for table service, buffets, salad bars or deli displays
- Made of glossy acrylic
- 8888 offers the increased durability of SAN and is safe for use in temperatures from 32° to 160°F
- Dishwasher safe



Octagonal Crocks & Platter

- Crock inserts eliminate waste while giving a full appearance
- 2.5 lb low profile crock (6723) can be used as an insert for the 5 lb crock
- 5 lb low profile crock (6726) can be used as an insert for the 10 lb crock
- Durable SAN plastic is resistant to food oils and acids
- Safe for use in temperatures from 0° to 180°F
- Dishwasher safe



Prod No	Description	Color	Pack
Octagon Bowls			
8886	2.5 lb, 7.13" x 2.87" Octagon Bowl	03	4 ea
8887	5 lb, 9.19" x 3.04" Octagon Bowl	03	4 ea
8888	8 lb, 9.38" x 4.1" Dia Deep Octagon Bowl	03	4 ea
Octagonal Crocks & Platter			
6713	5 lb, 10.63" x 7.19" Octagonal Crock	03	6 ea
6723	2.5 lb Low Profile Octagonal Crock (and Insert for 5 lb Crock 6713)	02, 03	6 ea
6716	10 lb, 13.31" x 10.5" Octagonal Crock	03	6 ea
6726	5 lb Low Profile Octagonal Crock (and Insert for 10 lb Crock 6716)	03	6 ea

DISPLAYWARE

Make waves with our modular displayware! This modular melamine display system gives you so many options in setting up your display and it all looks perfectly organized when you are done.

Modular Displayware

- Wave shape offers visual interest while enhancing the display
- Unique, flexible displayware provides an attractive solution for merchandising prepared food
- Fits in standard size food wells
- Half long lid can be used as a display tray for sliced deli meats and cheeses
- Made of tough, break-resistant polycarbonate
- Safe for use in temperatures ranging from -40° to 212°F
- NSF Listed; dishwasher safe



Collar provides support for smaller pans when used in a food well



Prod No	Description	Color	Pack
Modular Displayware			
6982 Δ	4.45 qt Half Long Pan - Wavy Edge	03, 07	6 ea
6990 Δ	4.45 qt Half Long Pan - Straight Edge	03, 07	6 ea
6982L Δ	Half Long Lid	07	6 ea
6988 Δ	Half Long Collar	03, 07	6 ea
6984 Δ	6.5 cup, 2.5" Deep Half Size Pan	03, 07	6 ea
69844 Δ	9.25 cup, 4" Deep Half Size Pan	03, 07	6 ea
69846 Δ	13 cup, 6" Deep Half Size Pan	03, 07	6 ea
6984L Δ	Half Size Lid	07	6 ea
6986 Δ	4 cup, 2.5" Deep Third Size Pan	03, 07	6 ea
69864 Δ	5.6 cup, 4" Deep Third Size Pan	03, 07	6 ea
69866 Δ	7.8 cup, 6" Deep Third Size Pan	03, 07	6 ea
6986L Δ	Third Size Lid	07	6 ea

NSF Listed products are designated with a Δ and may be prefixed with an N

Rectangular Deli Crocks & Platter

- Rectangular deli crocks save space in display cases
- Acrylic crocks have a high gloss finish
- Safe for use in temperatures from 32° to 160°F
- Dishwasher safe



Deliware® Rectangular Crocks

- Economical durable polypropylene for maximum impact resistance in cold temperatures
- Safe for use in temperatures from 32° to 170°F



Prod No	Description	Color	Pack
Rectangular Deli Crocks & Platter			
8508	12" x 8" Rectangular Platter	03	6 ea
8819	5 lb , 10" x 6" Rectangular Crock	03	4 ea
8821	10 lb, 12" x 10" Rectangular Crock	03	4 ea
Deliware Rectangular Crocks			
8110	5 lb, 10" x 6" Rectangular Crock	02, 03	12 ea
8112	10 lb, 12.5" x 10.25" Rectangular Crock	02, 03	6 ea

DISPLAYWARE

Petal Mist® Plates, Bowls & Trays

- Petal Mist's delicate design gives an elegant appearance; perfect for buffets, food bars, delis, poolside, and catering
- Textured exterior hides scratches; easy-clean smooth interior
- Made of tough, break-resistant polycarbonate
- Safe for use in freezers and in temperatures from 40° to 212°F
- Coordinates with Petal Mist Dinnerware—See page 28
- NSF Listed; dishwasher safe



Prod No	Description	Color	Pack
Petal Mist Plates, Bowls & Tray			
6908 Δ	1.2 qt, 7.5" Petal Mist Bowl	03, 07	36 ea
6909 Δ	2.4 qt, 9" Petal Mist Bowl	03, 07	12 ea
6931 Δ	3.4 qt, 9.75" Petal Mist Bell Bowl fits 8.25" template opening	03, 07	4 ea
6914 Δ	5.6 qt, 12" Petal Mist Bowl	03, 07	4 ea
6917 Δ	9.7 qt, 15" Petal Mist Bowl	03, 07	4 ea
6919 Δ	17.2 qt, 18" Petal Mist Bowl	03, 07	4 ea
6942 Δ	13" Petal Mist Plate	07	6 ea
6947 Δ	16" x 22" Petal Mist Rectangular Tray	07	6 ea

NSF Listed products are designated with a Δ and may be prefixed with an N

Bell Bowls

- SB90 pebbled design made of crystal-clear acrylic
- 7325 pebbled bowl made of break-resistant polycarbonate
- Dishwasher safe



7325

Stack Bowls

- Use for food bars, buffets, or table service
- 15" deep rim gives a stylish bowl appearance when placed into ice or refrigerated food bar templates
- Acrylic is resistant to food acids and oils
- Dishwasher safe



8038

8099

Leaf Bowls

- Perfect for salad bar or table service
- Acrylic is resistant to food acids and oils
- For use in temperatures from 32° to 160°F
- Dishwasher safe



LB16

LB12

LB10

Buffet Clam Shells

- Perfect for presenting seafood, salads, and appetizers in a buffet or salad bar
- Durable SAN plastic is resistant to food oils and acids
- Safe for use in temperatures from 0° to 180°F
- Dishwasher safe



0344

339

0340



Prod No	Description	Color	Pack
Bell Bowls			
7325	3.3 qt, 11" Polycarbonate Pebbled Bowl	07	12 ea
SB90	3.3 qt, 11" Acrylic Pebbled Bowl	07	4 ea
SB94	6 qt, 14" Acrylic Pebbled Bowl	07	4 ea
Stack Bowls			
8038	1.5 qt, 8" x 3.5" Stack Bowl	03	4 ea
8099	2.5 qt, 9" x 3.5" Stack Bowl	03	4 ea
8100	3 qt, 9.5" x 4" Stack Bowl	03	4 ea
Leaf Bowls			
LB10	1.5 qt, 9.38" Leaf Bowl	07	4 ea
LB12	3 qt, 11.25" Leaf Bowl	07	4 ea
LB16	8 qt, 15.38" Leaf Bowl	07	4 ea
Buffet Clam Shells			
339	12 oz, 8.88" x 5.5" Small Clam Shell	02, 07	12 ea
0340	22 oz, 11" x 7" Medium Clam Shell	02, 03, 07	12 ea
0344 Δ	5 qt, 19" x 12.88" Large Clam Shell	02, 03, 07	1 ea

NSF Listed products are designated with a Δ and may be prefixed with an N



DISPLAYWARE

Round Polycarbonate Pebbled Bowls

- Pebbled exterior resists scratches
- Smooth interior is unaffected by salad oils, food acids, or dressings
- Durable polycarbonate is safe for use in temperatures from 40° to 212°F
- NSF Listed; dishwasher safe



Acrylic Pebbled Bowls

- Acrylic bowls have heat polished, high-gloss rim
- Pebbled finish resists scratches
- Dishwasher safe



Prod No	Description	Color	Pack
Round Polycarbonate Pebbled Bowls			
7206 Δ	0.6 qt, 6" Round PC Bowl	07	12 ea
7208 Δ	1.62 qt, 8" Round PC Bowl	07	12 ea
7210 Δ	3 qt, 10" Round PC Bowl	07	12 ea
7212 Δ	5.5 qt, 12" Round PC Bowl	07	12 ea
7215 Δ	11 qt, 15" Round PC Bowl	07	4 ea
7218 Δ	18 qt, 18" Round PC Bowl	07	4 ea
7223 Δ	33 qt, 23" Round PC Bowl	07	4 ea
Round Acrylic Pebbled Bowls			
SB66	.5 qt, 6" Acrylic Round Bowl	07	8 ea
SB68	1 qt, 8" Acrylic Round Bowl	07	4 ea
SB70	2 qt, 10" Acrylic Round Bowl	07	4 ea
SB72	4 qt, 12" Acrylic Round Bowl	07	4 ea
SB74	7 qt, 14" Acrylic Round Bowl	07	4 ea
SB76	10 qt, 16" Acrylic Round Bowl	07	4 ea
SB78	15 qt, 18" Acrylic Round Bowl	07	4 ea
SB79	24 qt, 22" Acrylic Round Bowl	07	4 ea
Oval Acrylic Pebbled Bowls			
OSB172	5.5 qt, 10.5" x 14" Acrylic Oval Bowl	07	4 ea
OSB176	11 qt, 13" x 18" Acrylic Oval Bowl	03, 07	4 ea
OSB178	15 qt, 15.25" x 21.88" Acrylic Oval Bowl	03, 07	4 ea

NSF Listed products are designated with a Δ and may be prefixed with an N
 Shipping Notes: 7223 and SB79 can ship UPS/FedEx Ground at oversize cost

Double-Wall Stainless Steel Displayware

- Beautiful, heavy-duty, stainless steel displayware designed for delis, buffets, and special event service
- The modern hammered finish hides scratches for a longer life
- Double wall construction provides insulation to help with temperature retention with both hot and cold foods; no need to preheat or chill
- Double wall construction with air insulation prevents sweating for a fresher looking display
- 609201, 609202, 609203, and 609204 bowls have dual-base indentions allowing bowls to sit flat or at an angle for a more dramatic display and easy food access
- Keeps food under 41°F for up to 2 hours or more



Double Wall Construction/Air Insulation:

- Helps with temperature retention for both hot and cold foods
- Keeps food under 41°F for up to 2 hours or more

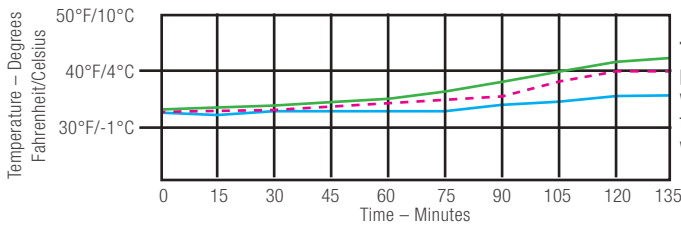

- 609211 3.5 qt, 10" Square Bowl
- 609209 4.38 qt, 10-3/4" Serving Bowl
- 609204 9.5 qt, 14" Dual Angle Bowl

Testing Conditions: Chilled cottage cheese was placed in a room temperature bowl. The bowls were left undisturbed in a 72° to 78°F room until temperatures rose above 40°F. Temperature in center was measured and recorded in 5 minute increments.

Prod No	Description	Pack
Double-Wall Stainless Steel Displayware		
609201	1.7 qt, 8" Dual Angle Bowl with Hammered Finish	2 ea
609202	3.38 qt, 10" Dual Angle Bowl with Hammered Finish	2 ea
609203	5.75 qt, 12" Dual Angle Bowl with Hammered Finish	2 ea
609204	9.5 qt, 14" Dual Angle Bowl with Hammered Finish	2 ea
609208	2.5 qt, 9.25" Serving Bowl with Hammered Finish	2 ea
609209	4.38 qt, 10.75" Serving Bowl with Hammered Finish	2 ea
609211	3.5 qt, 10" Square Bowl with Hammered Finish	2 ea
609215	12" x 7" Curved Tray with Hammered Finish	2 ea
609216	15" x 8.5" Curved Tray with Hammered Finish	2 ea



DISPLAYWARE

Balti Dishes

- Handled bowls are great for food preparation and presentation, deli display, or family style dining
- High polish 18-2 stainless steel
- Dishwasher safe



609093

Square Display Dishes

- Handled bowls are great for food preparation and presentation, deli display, or family style dining
- Handles collapse to minimize display space used
- High polish 22 gauge stainless steel
- Dishwasher safe



609083

609082

Allegro® Display Bowls

- Multi-purpose bowls for candies, fruit, dressings, sauces, and rolls
- Mirror-polished finish; 18-10 stainless steel
- Hand washing recommended



609196

609171

609173



Prod No	Description	Pack
Balti Dishes - Stainless Steel		
609092	20 oz, 6" Balti Dish	12 ea
609093	30 oz, 6.75" Balti Dish	12 ea
609094	44 oz, 7.5" Balti Dish	12 ea
609096	72 oz, 9.5" Balti Dish	12 ea
609097	96 oz, 10.25" Balti Dish	12 ea
Square Display Dishes - Stainless Steel		
609082	6" Square Display Dish	12 ea
609083	8" Square Display Dish	12 ea
609084	10" Square Display Dish	12 ea
609085	12" Square Display Dish	12 ea
609086	14" Square Display Dish	12 ea
Allegro Display Bowls - Stainless Steel		
609171	20 oz, 5.25" Allegro Display Bowl	6 ea
609172	26 oz, 5.88" Allegro Display Bowl	6 ea
609173	48 oz, 7" Allegro Display Bowl	3 ea
609196	3 qt, 9.5" Allegro Display Bowl	1 ea

*Note: Not for use in hot wells or ovens

Display Covers (Cover Only)

- Covers enhance and protect the look of your food items; helps keep food fresh
- Use for merchandising fresh fruits, desserts, salads, sandwiches, or bakery items
- Polycarbonate dome covers add increased durability and can be used in more extreme foodservice applications



PSD21EH

Use Display Covers with our full- and half-size food pans shown on pages 222-223

Cake Covers & Tray

- Clear covers display desserts and pastries
- Sanitary covers help keep foods fresher longer
- Dishwasher safe



2512

3004

SC32

Step Risers

- Step Risers create height in your food presentation
- Offers better visibility and helps merchandise foods

Polycarbonate Step Risers

- 6843 polycarbonate riser is virtually unbreakable; won't dent or chip

ABS Step Risers

- Edges have air slots for increased air circulation
- ABS plastic is very durable and easy to clean; will not warp or chip
- Textured satin finish decreases glare, hides scratches



6863

6843



Prod No	Description	Pack
Display Covers (Trays Not Included)		
PSD13EH	12" x 10" End Cut Display Cover	1 ea
PSD13CH	12" x 10" Center Cut Display Cover	1 ea
PSD21EH	12" x 20" End Cut Display Cover	1 ea
PSD21CH	12" x 20" Center Cut Display Cover (7.88" x 6.75" opening)	1 ea
PSD21DEH	12" x 20" Double End Cut Display Cover	1 ea
Cake Covers & Tray		
SC32	12" x 6" Cake Cover, Acrylic	6 ea
2512	12" x 6.5" Cake Cover, SAN	6 ea
3004	14" Display Tray, SAN	12 ea
Step Risers		
6843 Δ	11.75" 3-Step Polycarbonate Riser	1 ea
6863	23.5" 3-Step Riser ABS Riser	1 ea

NSF Listed products are designated with a Δ and may be prefixed with an N



SERVINGWARE

Aria™

- Heavy-duty, and more economical than comparable hollow handle items
- Ladles have one ounce oval shaped bowl for pouring dressings from either side



Prod No	Description	Pack
Aria		
609001	12" Aria Solid Spoon	12 ea
609002	12" Aria Slotted Spoon	12 ea
609003	11.5" Aria Notched Spoon	12 ea
609005	10.75" Aria Cold Meat Fork	12 ea
609006	11.75" Aria Wide Pie Server	12 ea
609007	11" Aria Narrow Pastry Server	12 ea
609009	10" Aria Solid Spoon	12 ea
600295	9.5" Aria Ladle	12 ea
600296	13.5" Aria Ladle	12 ea
604460	9.25" Aria Solid Spoon	12 ea
604606	6" Aria Salad Tong	12 ea
604609	9" Aria Salad Tong	12 ea

Buffet Tongs

- Heavy-duty 18-8 stainless steel with mirror polished finish for long lasting use
- Durable sanitary one-piece construction
- Scissor tongs are two-piece satin finish construction
- Dishwasher safe



Prod No	Description	Pack
Buffet Tongs		
607680	8" Pastry Tong	12 ea
607682	8" Serving Tong	12 ea
607683	10.25" Scalloped Serving Tong	12 ea
607685	10" Scissors Salad Tong	12 ea
607687	9.25" Bread Serving Tong	12 ea
607690	5.75" Ice Tong	12 ea
607691	7" Ice Tong	12 ea
607692	10" Scalloped Bread Serving Tong	12 ea
607693	9" Salad Tong	12 ea
607695	9.5" Pastry Tong	12 ea
607697	11.75" Serving Tong	12 ea

ICE SCULPTURES & PUNCH BOWLS

Ice Sculptures

- Quick and easy way to turn any table into a showpiece
- Fill mold with water, freeze (48-72 hours), and cut open the mold
- Features patented EZ-Cut Bead™ and Contracting Cone Base™
- One time use
- Instructions included with every Ice Sculpture



SCL1



SSW1



SD01



SBG1

Contracting Cone Base allows for expansion while freezing to eliminate the major cause of cracking and breaking in the freezing process.

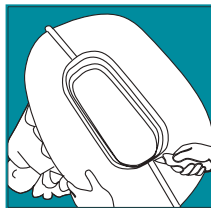

SEA1

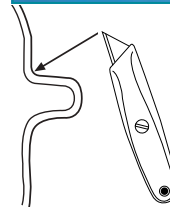

Exclusive EZ-Cut Bead opening system makes it quick and easy to un-mold a work of art.



SD01

Illuminated Trays

- Perfect for use at buffets or banquets, or as an accent for ice sculptures
- Light boxes come with Blue, Red, and Yellow colored panels
- Light box is UL listed, fuse protected and operates on 115 volt/60 cycle AC
- Drain kits included

White(02)

Designated(00)

Prod No	Description	Color	Pack
Ice Sculptures			
SSW1	Swan: 19" L x 12" W x 21.5" H	02	1 ea
SD01	Dolphin: 20.5" L x 14.25" W x 25" H	02	1 ea
SBG1	Bride and Groom: 22" L x 14" W x 28" H	02	1 ea
SCL1	Clam Shell: 18" L x 12" W x 19" H	02	1 ea
SEA1	Eagle: 15.5" L x 24" W x 29" H	02	1 ea
Illuminated Trays			
SL6011L	Large Light Box (no tray)	00	
SL6011TC*	Large Smooth Light Box Tray (only)	00	1 ea

* Drain Kits are included with Light Box Tray

NOTE: Light Boxes & Trays are sold separately; SGR1, SHR1, SD01, SBG1, SCL1, SEA1, SBA1, and SFI1 can be shipped UPS/FedEx Ground at oversize cost

Pebbled Punch/Serving Bowls

- Pebbled exterior hides scratches
- Break-resistant acrylic
- Safe for use in temperatures from 32° to 160°F



SP18

Punch/Serving Bowls

- Mirror-polished finish exterior and rim, satin finish interior
- Heavy gauge 18-8 stainless steel with argon welded bases for exceptional strength
- Handwashing recommended



609310

609316

Clear(07)

Prod No	Description	Color	Pack
Punch/Serving Bowls			
SP18	16 qt, 17.5" Pebbled Punch Bowl	07	1 ea
SP22	24 qt, 22" Pebbled Punch Bowl	07	1 ea
609310	10 qt, 15.5" Punch/Serving Bowl	—	1 ea
609316	16 qt, 18" Punch/Serving Bowl	—	1 ea

NSF Listed products are designated with a **Δ** and may be prefixed with an N



BUFFET ACCESSORIES

MirAcryl™ Cubes

- Design allows smaller size cubes to nest inside larger cubes for convenient storage
- Invert to use as ice bucket or wine server
- Light-weight, break-resistant acrylic



MirAcryl Mirrored Display Trays

- Beautiful, durable display pieces are easy to clean
- Made of light-weight acrylic
- Two-sided surface – use Mirrored or solid Black side for display



Mirror Acrylic(23)

Prod No	Description	Color	Pack
MirAcryl Cubes			
SMMC8	8" Mirror Cube	23	1 ea
SMMC10	10" Mirror Cube	23	1 ea
SMMC12	12" Mirror Cube	23	1 ea
MirAcryl Mirrored Display Trays			
SMOC24	24" Octagon MirAcryl Tray	23	1 ea
SMO1624	24" x 16" Oval MirAcryl Tray	23	1 ea
SMO2232	32" x 22" Oval MirAcryl Tray	23	1 ea
SMR1624	24" x 16" Rectangle MirAcryl Tray	23	1 ea
SMR1836	36" x 18" Rectangle MirAcryl Tray	23	1 ea
SMR12	12" Round MirAcryl Tray	23	1 ea
SMR16	16" Round MirAcryl Tray	23	1 ea
SMR24	24" Round MirAcryl Tray	23	1 ea
SMTD16	16" Teardrop MirAcryl Tray	23	1 ea
SMTD24	24" Teardrop MirAcryl Tray	23	1 ea

NOTE: MirAcryl™ is not returnable if the protective film is removed

Allegro™ Display Stand

- Heavy-weight bases with argon welding for exceptional strength
- Mirror-polished finish
- 18-10 stainless steel
- Handwashing recommended
- May be used as a two tier display stand by not using one upright and one tray



NeWave™ Drip Trays

- Patented NeWave Drip Trays with open, free-flowing design dissipates fluid spills evenly to allow quicker evaporation
- NeWave pattern keeps mug, cup, and pitcher bases dryer by eliminating the common fluid traps on other designs
- Easy to empty and clean
- NSF Listed; dishwasher safe

Octagonal Drip Tray U.S. Patent No. D-418,376;
Rectangular Drip Tray U.S. Patent No. D-418,377



Black(03)

Prod No	Description	Color	Pack
Allegro Display Stand			
609170	Allegro Three Tier Display Stand	—	1 ea
NeWave Drip Trays			
11020 Δ	NeWave 4" Square Drip Tray	03	12 ea
11030 Δ	NeWave 4" Octagon Drip Tray	03	12 ea
11026 Δ	NeWave 6" Square Drip Tray	03	12 ea
11036 Δ	NeWave 6" Octagon Drip Tray	03	12 ea

NSF Listed products are designated with a Δ and may be prefixed with an N





INNOVATIVE GUEST- PLEASING VERSATILE DEPENDABLE **FOOD BARS & CONVENIENCE PRODUCTS**

Carlisle's workhorse portable food bars, innovative Coldmaster line, and industry leading line-up of serving and convenience smallwares are critical dining supplies for your operation. We develop products with the needs of demanding foodservice professionals like you in mind. You can count on Carlisle to factor in food safety, attractive and operationally efficiency, rugged durability, and one stop shop availability.





COLDMASTER®

The Coldmaster solution **eliminates** the **inconvenience** and mess of ice, as well as reduces the potential for bacteria. The Coldmaster solution is **revolutionizing** the food pan category, offering **innovative** solutions and **making work easier**.



Coldmaster® CoolCheck™

- Patent-pending technology allows you to quickly see when temperatures are no longer safe
- Same great features as our standard Coldmaster products with the added element of color-changing technology
- Eliminates the guessing game behind food safety
- Unit holds food safely below 41°F for 6-8 hours*
- Reduces waste by “telling” workers when food temperature is safe
- Eliminates the mess and inconvenience of ice
- FDA approved; dishwasher safe
- Use Coldmaster Lids listed on pages 111-112
- NSF Listed

*Time will vary based on ambient room temperature

Designed to fit in standard sized food pan templates or food wells



White(02)

Prod No	Description	Color	Pack
Coldmaster CoolCheck			
CM1100C14 Δ	6" Deep Full-size Food Pan	02	1 ea
CM1101C14 Δ	6" Deep Half-size Food Pan	02	1 ea
CM1102C14 Δ	6" Deep Third-size Food Pan	02	1 ea
CM1103C14 Δ	6" Deep Third-size Divided Food Pan	02	1 ea
CM1104C14 Δ	6" Deep Sixth-size Food Pan	02	1 ea
CM1105C14 Δ	6" Deep High Capacity Sixth-size Food Pan	02	1 ea

NSF Listed products are designated with a Δ and may be prefixed with an N



The Coldmaster Solution:



- High-impact ABS plastic holds up to foodservice use
- Exclusive refrigerant gel ensures high performance
Non-toxic gel receives a cold "charge" when frozen overnight, which enables it to keep your food cold throughout the day
- Extra insulation surrounds refrigerant gel for maximum cold retention
- Refrigerant gel is enclosed in a bag; prevents leaks, even if shell is damaged

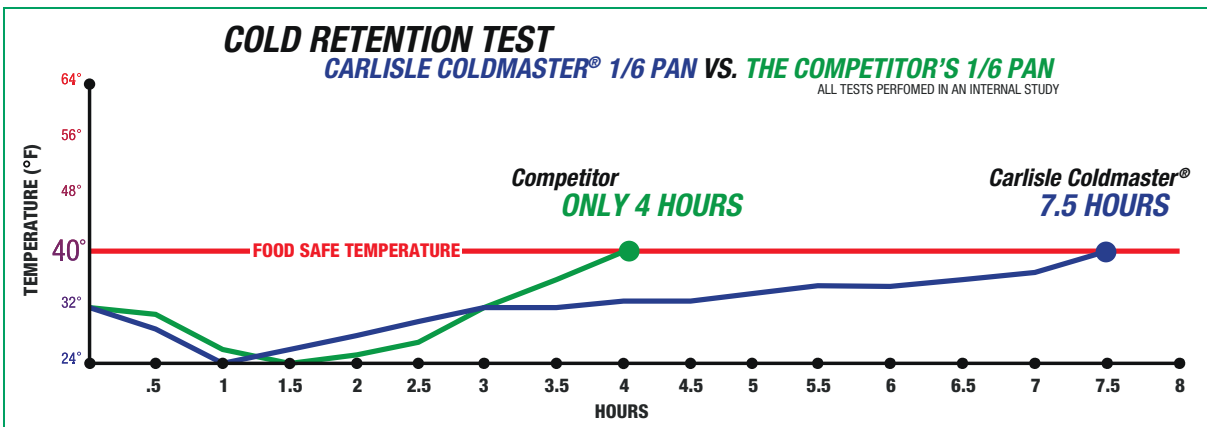

Coldmaster line includes a full suite of **COLD RETENTION SOLUTIONS** such as 3 gallon ice-cream servers, condiment bars and industry firsts such as CoolCheck™ and Designer pans

- Exclusive refrigerant gel ensures **HIGH PERFORMANCE**
- **NON-TOXIC** gel receives a cold "charge" when frozen overnight, which enables it to keep your food cold throughout the day
- Extra insulation surrounds refrigerant gel for **MAXIMUM COLD RETENTION**



- Refrigerant gel is enclosed in a bag; **PREVENTS LEAKS**, even if shell is damaged, ensures 100% coverage, and helps keep it in place

VS.

Competitor



- Gel is not enclosed in a bag, less protection if there is a break
- Units must be stored upside down or food in the unit is not chilled at the top of the pan
- No additional insulation means that there is much less "chill time"
- Limited Assortment



COLDMASTER®

Coldmaster = Peace of Mind

Coldmaster products are available in a variety of shapes and sizes from food pans to crocks, to ice cream servers. Coldmaster offers peace of mind while it keeps your food cold and fresh. Enjoy the convenience of Coldmaster, as it allows you to transport and keep food cold, anywhere you need to without messy ice or electricity.

Coldmaster Products Exceed Health Department Requirements

- With one overnight charge in your freezer, each Coldmaster keeps food at or below the ServSafe®* guidelines of 40°F for up to eight hours**

Coldmaster Products Meet FDA Standards

- All Coldmaster products are filled with an exclusive non-toxic refrigerant gel
- Constructed of high-impact ABS plastic
- Dishwasher safe



Coldmaster® Whipped Cream & 1 Quart Carton Chillers

- Chillers use the same technology as standard Coldmaster pans
- CM1107 is designed to hold a standard 1qt carton; keeps dairy/egg cartons cold up to 8 hours**
- CM1108 is designed to hold a whipped cream can and provide food-safe chilling for up to 8 hours**
- NSF Listed



Prod No	Description	Color	Pack
Coldmaster Chillers			
CM1107 Δ	1 Quart Carton Chiller	02, 03	1 ea
CM1108 Δ	Whipped Cream Can Chiller	02, 03	1 ea

*ServSafe is a registered trademark of the National Restaurant Association

**Temperature retention is based on crocks being pre-frozen for a minimum of eight hours, then filled directly with pre-chilled foods. Testing was conducted under ambient room temperatures of 76°F.

NSF Listed products are designated with a **Δ** and may be prefixed with an N



Standard Food Pans & Lids

- Designed to fit in standard sized food pan templates
- Save time and labor by placing food directly into Coldmaster Standard Pans
- Third-size divided splits into two sixth-size food pans
- NSF Listed



Coldmaster Lids

- Designed to fit Coldmaster Standard Food Pans
- Clear acrylic lid protects against contaminants
- Helps maintain cold temperatures so your food stays fresh longer
- Molded-in handle allows easy removal



Prod No	Description	Color	Pack
Coldmaster Standard Food Pans & Lids			
CM1100 Δ	6" Deep Full-size Food Pan	02, 03	1 ea
CM1101 Δ	6" Deep Half-size Food Pan	02, 03	1 ea
CM1102 Δ	6" Deep Third-size Food Pan	02, 03	1 ea
CM1103 Δ	6" Deep Third-size Divided Food Pan	02, 03	1 ea
CM1104 Δ	6" Deep Sixth-size Food Pan	02, 03	1 ea
CM1105 Δ	6" Deep High Capacity Sixth-size Food Pan	02, 03	1 ea
CM1125	Full-size Coldmaster Lid	07	2 ea
CM1126	Half-size Coldmaster Lid	07	2 ea
CM1127	Third-size Coldmaster Lid	07	2 ea
CM1128	Sixth-size Coldmaster Lid	07	2 ea

NSF Listed products are designated with a Δ and may be prefixed with an N



COLDMASTER® EZ ACCESS LIDS

Carlisle's EZ Access Lids were designed in **collaboration** with the people who **use our products everyday.**

Coldmaster EZ Access Lids

- Lids fit standard Coldmaster Food Pans shown on page 109
- Snug fit ensures they won't pop off, even when leveling a measure miser on the sidewall
- Innovative design includes lipped notches that allow the lid to be opened with a simple flick of the wrist or serving utensil
- Raised design does not impede maximum fill of your food pan
- Easy-clean design eliminates food traps and allows for easy cleanability
- Convenient hang hole for easy storage when not in use
- NSF Listed

Pan/Organizer with PC Food Pans and EZ Access Lids



CM1049

NEW PRODUCT



CM103190Z

CM10280Z



CM10240Z

Clear(07)

Prod No	Description	Color	Pack
Coldmaster EZ Access Lids			
CM10238Z Δ	1/2 Size Lid	07	2 ea
CM10239Z Δ	1/2 Size Lid with Notch	07	2 ea
CM10240Z Δ	1/2 Size Lid with 2 Notches	07	2 ea
CM10278Z Δ	1/3 Size Lid	07	2 ea
CM10279Z Δ	1/3 Size Lid with Notch	07	2 ea
CM10280Z Δ	1/3 Size Lid with 2 Notches	07	2 ea
CM10318Z Δ	1/6 Size Lid	07	2 ea
CM10319Z Δ	1/6 Size Lid with Notch	07	2 ea

NSF Listed products are designated with a Δ and may be prefixed with an N

COLDMASTER®

The **safest and most convenient** way to keep foods held in metal pans cold for **up to 8 hours** during outdoor or off-site events. Coldmaster Coldpans allow your operation to keep **limited-time-offer items** chilled **without having to expand your cold well.**

Coldmaster Coldpans

- Designed with the same capacity as traditional style food pans; will hold DuraPan™ Food Pans (pages 222-223)
- Holds and keeps standard food pans cold
- CM1049 Pan Organizer is a 6" deep full size coldpan designed to hold (9) ninth-size food pans for easy organization
- NSF Listed, dishwasher safe



Pan/Organizer with standard Food Pans



CM1049



CM1042LP

CM1045

CM1042

CM1046

CM1043



Prod No	Description	Color	Pack
Coldmaster Coldpans			
CM1042 Δ	6" Deep Full-size Coldpan (will hold full, third, or half size pans)	02, 03	1 ea
CM1040 Δ	4" Deep Full-size Coldpan (will hold full, third, or half size pans)	02	1 ea
CM1042LP	Full Size Coldpan Lid (fits CM1040, CM1042 and CM1049)	02	1 ea
CM1043 Δ	6" Deep Half-size Long Coldpan (will hold 1 half-long pan)	02	1 ea
CM1045 Δ	6" Deep Third-size Coldpan (will hold third, sixth, or ninth size pans)	02	1 ea
CM1046 Δ	6" Deep Two-Thirds size Coldpan (will hold two-third or third size pans)	02	1 ea
Coldmaster Pan/Organizer			
CM1049	6" Deep Full-size Coldpan with Organizer (does not include food pans)	02	1 ea

NSF Listed products are designated with a Δ and may be prefixed with an N



COLDMASTER®

Ice Cream Server & Lid

- Coldmaster technology and benefits (see pages 108-109)
- Accommodates standard 3-gallon ice cream tubs
- FREE, clear polycarbonate lid included with each Coldmaster Ice Cream Server
- Replacement Lids (CM1013) also available

Ice Cream Shroud

- Attractive stainless steel cover offers an upscale appearance



CM1012



CM1012 with 38655 Shroud

Coldcrock

- Same Coldmaster technology and benefits (see pages 108-109)
- Crock holds 2 quarts of salad, dressing, or condiments
- NSF Listed



CM1030



38600R

Coldcrock Accessories

- Use Standard Pump (CM1035) with ketchup, mayonnaise, mustard, or other sauces; can be used with or without insert to provide accurate .5 ounce or 1 ounce portions
- Fixed Nozzle Pump (38600R) dispenses 1 ounce per stroke; flow back design prevents messy dripping
- Maxi Pump (CM1037) dispenses 1 ounce portions of salsa, dressings, and other chunky condiments
- Maxi Pump's long nozzle allows easier dispensing; comes with snap-in nozzle restrictors to help eliminate dripping when dispensing thinner condiments



CM1037

CM1035

CM1033



Prod No	Description	Color	Pack
Coldmaster Ice Cream Server, Lid & Shroud			
CM1012 ▲	3 gal Coldmaster Ice Cream Server	02, 03	1 ea
CM1013	Lid for Coldmaster Ice Cream Server	07	1 ea
38655	Coldmaster Ice Cream Shroud	—	1 ea
Coldmaster Coldcrock & Accessories			
CM1030 ▲	2 qt Coldcrock (includes Coaster)	02, 03, 23	1 ea
CM1032	Clear Solid Lid	07	2 ea
CM1033	Clear Slotted Lid	07	2 ea
CM1033P	Clear Pump Lid (use with pumps below)	07	2 ea
CM1035	.5 or 1 oz Standard Pump	02	2 ea
CM1037	1 oz Maxi Pump includes 2 sizes Nozzle Restrictors	02	2 ea
38600R	1 oz Fixed Nozzle Pump	—	1 ea

NSF Listed products are designated with a ▲ and may be prefixed with an N



Condiment Bar Organizers

- Condiment organizer available for 3 or 6 qt Coldcrocks
- Organizer is made of sturdy, high-impact plastic
- Textured exterior hides scratches
- Order organizer separately or as a set with crocks, lid and pumps (CM1058)
- Coldcrocks (CM1030) sold separately; see facing page for details



CM1065 with Coldmaster Crocks



CM1050



CM1017

Coldbowl

- Coldmaster technology and benefits (see pages 108-109)
- Keeps food at or below 40°F for up to five hours
- 12 quart capacity is perfect for buffets and food bars
- NSF Listed



Dispenser

- Coldmaster technology & benefits
- Perfect for milk, cream, and other temperature sensitive condiments
- Faucet style dispenser offers better control for dispensing liquids

Find replacement parts at www.carlislefsp.com/replacement-parts



Prod No	Description	Color	Pack
Coldmaster Condiment Bar Organizers			
CM1058	Crock & Organizer Condiment Set (3-Crock Coldcrock Organizer and 3 ea Coldmaster Crocks, Pump Lids, and Condiment Pumps)	02	1 set
CM1065	6-Crock Coldcrock Organizer (only)	02	1 ea
CM1069	3-Crock Coldcrock Organizer (only)	02	1 ea
Coldmaster Coldbowl			
CM1050 Δ	12 qt, 18" Coldbowl	02	1 ea
Coldmaster Dispenser			
CM1017	5 qt Coldmaster Milk Dispenser & Lid	03	1 ea

NSF Listed products are designated with a Δ and may be prefixed with an N



CROCKS

Coordinate with colorful quality crocks from Carlisle. We've got the **durability, beauty, and value** you are looking for in a variety our competitors can't beat. Each style has its own features and benefits so you can **select the crock that best suits your needs.**



Classic

- Thick-walled, heavy-weight design; made of SAN
- Chemical resistance to food acids and dressings
- High-gloss finish is extremely scuff-resistant
- 0°F to 180°F temperature range
- 0.6 quart crock fits inside 1.2 quart crock for smaller portions
- Translucent snap-on lids included
- NSF Listed; dishwasher safe

Poly-Tuf™

- Optimum wall design gives greater break-resistance
- Glossy-finish crocks resist chipping and cracking
- Withstands temperatures from 32°F to 180°F
- Translucent snap-on lids included
- NSF Listed; dishwasher safe



Prod No	Description	Color	Pack
Classic Crocks			
0300 Δ	0.6 qt Classic Crock with Lid	03	12 ea
0301 Δ	1.2 qt Classic Crock with Lid	01, 02, 03, 06, 07	12 ea
0316 Δ	1.5 qt Classic Crock with Lid	01, 03, 06, 07	6 ea
0302 Δ	2.7 qt Classic Crock with Lid	01, 02, 03, 06, 07	6 ea
0304 Δ	4.0 qt Classic Crock with Lid	03	6 ea
Poly-Tuf Crocks			
0341 Δ	1.2 qt Poly-Tuf Crock with Lid	01, 03, 06	12 ea
0343 Δ	1.5 qt Poly-Tuf Crock with Lid	01, 03, 06	6 ea
0342 Δ	2.7 qt Poly-Tuf Crock with Lid	01, 03, 06	6 ea
Replacement Lids For Classic & Poly-Tuf Crocks			
0311 Δ	Lid - 0.6/1.2 qt (fits 0300, 0301, 0341)	30	12 ea
0202 Δ	Lid - 1.5/2.7 qt (fits 0302, 0316, 0342, 0343)	30	6 ea
0602 Δ	Lid - 4 qt (fits 0304)	30	12 ea

NSF Listed products are designated with a **Δ** and may be prefixed with an N



Supreme

- Same features as our Classic Crock, but with a 1.5" deep rim
- Gives a stylish bowl-like appearance when dropped into food bar templates
- 6.5" diameter (under rim) fits most template openings
- Translucent snap-on lids included
- NSF Listed; dishwasher safe



Gourmet

- Unique bowl shaped rim with deep crock base
- Stylish frosted pattern on rim helps hide scratches
- Break-resistant polycarbonate takes heat up to 212°F
- Translucent snap-on lids included
- NSF Listed; dishwasher safe



Classic Crock Condiment Station

- Includes organizer, three clear 2.7 quart Classic Crocks with Standard Pumps and Lids
- Organizer made of durable, scratch-resistant textured ABS plastic
- Holds standard size one gallon condiment or 2.7 quart Classic Crocks



Find replacement parts at www.carlislefsp.com/replacement-parts



Prod No	Description	Color	Pack
Supreme Crocks			
0365 Δ	1.5 qt Supreme Crock with Lid	03, 07	6 ea
0372 Δ	2.7 qt Supreme Crock with Lid	03	6 ea
0202 Δ	Replacement Lid - 1.5/2.7 qt (fits 0365, 0372)	30	12 ea
Gourmet Crocks			
7039 Δ	Gourmet Crock with Lid	03, 07	6 ea
7038 Δ	Replacement Lid	30	12 ea
Classic Crock Condiment Station			
0306	3-Crock Condiment Station Kit (includes three clear crocks, pumps, and lids)	00	1 ea

NSF Listed products are designated with a Δ and may be prefixed with an N



COLOR-COORDINATED ACCESSORIES

Carlisle has the **largest selection of color coordinated accessories** to complement our Food Bar, Buffet, and Deli Items. **One-piece construction** makes Carlisle accessories more **durable and easier to clean**. Carlisle offers color-coordinated accessories for every kitchen application from **high heat to portion control**.

Tongs

High Temperature Carly® Tongs

- Carries a two-year limited warranty
- Made of revolutionary plastic material for strength and longevity
- Can be used on high temperature surfaces like steam tables
- Withstands heat up to 300°F
- NSF Listed; dishwasher safe



Clear Carly Tongs

- Break-resistant polycarbonate
- Recommended for temperatures up to 212°F; and dry heat up to 270°F
- NSF Listed; dishwasher safe



Prod No	Description	Color	Pack
High Temperature Carly Tongs			
4606 ▲	6" Carly Salad Tong	01, 02, 03, 05, 06	12 ea
4609 ▲	9" Carly Salad Tong	01, 02, 03, 05, 06, 08	12 ea
4709 ▲	9" Carly Utility Tong	01, 02, 03, 05, 06, 08	12 ea
4712 ▲	12" Carly Utility Tong	01, 02, 03, 05, 06	12 ea
4806 ▲	6" Carly Pom Tong	01, 03, 06	12 ea
Clear Carly Tongs			
4006 ▲	6" Carly Salad Tong	07	12 ea
4009 ▲	9" Carly Salad Tong	07	12 ea
4109 ▲	9" Carly Utility Tong	07	12 ea
4206 ▲	6" Carly Pom Tong	07	12 ea

NSF Listed products are designated with a ▲ and may be prefixed with an N



Ladles

Carly Ladles

- Two-year limited warranty
- 1 ounce, oval-shaped bowl allows pouring from both sides
- Available in 9.5" and 13.5" lengths
- NSF Listed; dishwasher safe



TOP SELLER



Standard Ladles

- Two-year limited warranty
- .75 ounce bowl with spouts on each side for easy pouring
- Available in 10.5" length
- NSF Listed; dishwasher safe



Serving Spoons, Buffet Spoons & Pasta Forks

- Two-year limited warranty
- Recommended for temperatures up to 212°F
- Withstands dry heat up to 270°F
- Serving Spoons have notch in handle so spoon can rest on edge of food pan
- NSF Listed; dishwasher safe



Salad Spoon

- Large flat edge for easy scooping
- 7.25" handle for easy reach
- Durable SAN material
- NSF Listed; dishwasher safe

Brown(01)	White(02)	Black(03)	Red(05)	Beige(06)	Clear(07)	Forest Green(08)

Prod No	Description	Color	Pack
Ladles			
0295 Δ	9.5" Carly Ladle	01, 02, 03, 05, 06, 07	12 ea
0296 Δ	13.5" Carly Ladle	03	12 ea
0287*	9.5" Carly Ladle (Assorted Imprinted)	03	1 set
0240 Δ	10.5" Standard Ladle	03, 07	48 ea
0261*	10.5" Standard Ladle (Assorted Imprinted)	03	1 set
Spoons & Pasta Fork			
4410 Δ	11" Solid Serving Spoon	02, 03, 05, 06, 07, 08	12 ea
4411 Δ	11" Perforated Serving Spoon	03, 07	12 ea
4420 Δ	13" Solid Serving Spoon	02, 03, 05, 06, 07	12 ea
4421 Δ	13" Perforated Serving Spoon	03	12 ea
4430 Δ	15" Solid Serving Spoon	03, 07	12 ea
4431 Δ	15" Perforated Serving Spoon	03	12 ea
4450 Δ	.25 oz, 8" Solid Buffet Spoon	03, 06, 07	12 ea
4460 Δ	.5 oz, 8" Solid Buffet Spoon	01, 02, 03, 05, 06, 07, 08	12 ea
4470 Δ	.75 oz, 10" Solid Buffet Spoon	01, 03, 05, 06, 07	12 ea
4471 Δ	.75 oz, 10" Perforated Buffet Spoon	01, 03, 06	12 ea
4355	9.5" Pasta Fork	03	12 ea
509 Δ	11" Salad Spoon	01, 03	48 ea

NSF Listed products are designated with a Δ and may be prefixed with an N
 Note: *Assortment Packs includes one each of Bleu Cheese, Lo-Cal, Italian, House, French, Ranch, Thousand Island, & Caesar, plus four plain Imprinted Ladles: Handle imprinted in white with dressing name



FOOD BARS

The Maximizer Food Bar enables you to **serve food anywhere!** Perfect for use with ColdMaster® Food Pans to keep food **below 40° for up to 8 hours.**

7711

Maximizer™ Food Bar

- 6 foot Maximizer Food Bar offers upscale European styling
- Use with ice or with Coldmaster® Standard Food Pans to keep food at 40°F or below for up to eight hours
- Double-sided, acrylic sneeze guard attaches to post with six screw-in knobs
- Basin and cabinet come assembled (no tools required)
- NSF Listed



Tilting sneeze guard makes it easier to clean and fill food bar and can be used as a service line sandwich bar



Holds six full size food pans (20% more than any other similar system)

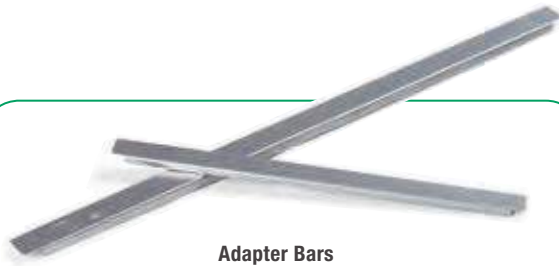

Adapter Bars

Use with various food pans to set up a number of food bar configurations, see page 222 for more information

Maximizer Food Bar Coupon Available
www.carlislefsp.com/ecoupons

Find replacement parts at
www.carlislefsp.com/replacement-parts

Molded from durable polyethylene and filled with thick polyurethane foam to keep food at correct serving temperatures for hours



Prod No	Description	Color	Pack
Maximizer Food Bar & Accessories			
7711 Δ	6 ft Maximizer Food Bar	01, 03, 08, 59	1 ea
7721 Δ	6 ft Maximizer Tray Slide	01, 03, 08, 59	1 ea
7725 Δ	Maximizer End Shelf	01, 03, 08, 59	1 ea

NSF Listed products are designated with a Δ and may be prefixed with an N



FOOD BARS

Features **high-tech coating** to keep the Six Star Food Bar **looking great for years** to come and provides **easy clean up.**

Six★Star™ Food Bars

- Molded with thick polyurethane foam for hours of insulation
- Use with ice or with Coldmaster® Standard Food Pans to keep food at 40°F or below for up to eight hours
- Two-piece acrylic shields allow for easy assembly
- Specially coated finish gives a beautiful glossy sheen and makes clean up easier
- Faucet-type drain plug facilitates water removal
- Add tray slides and end shelves without removing legs
- Sturdy, recessed, 5" non-marking swivel casters, two with brakes
- Easy to assemble
- NSF Listed



6605 with 6620 Tray Slide



6608 with 6621 Tray Slide



6600

Portable Food Bars

- Legs only unit available in 4 or 6 foot models

Youth Bar

Set up a Sundae Station using our Cold Master 3 gallon Ice Cream Server and crocks filled with all the fixins'

- Low 29" serving height is designed for young people to conveniently reach all condiments

Tabletop Bars

Perfect for a Happy Hour Bar!

- Threaded drain plug underneath ice pan for easy water removal

6611 with 6621 Tray Slide 6625 End Shelf





Portable Enclosed Bars

- 6 foot unit with enclosed storage unit and sliding doors

Find replacement parts at
www.carlislefsp.com/replacement-parts



Prod No	Description	Color	Pack
Six★Star Food Bars & Accessories			
6600 ▲	4 ft Six★Star Tabletop	01, 03, 05, 08	1 ea
6601 ▲	6 ft Six★Star Tabletop	03	1 ea
6605 ▲	4 ft Six★Star Portable with Legs only	01, 03, 08	1 ea
6606 ▲	6 ft Six★Star Portable with Legs only	01, 03, 08	1 ea
6611 ▲	6 ft Six★Star Portable with Storage & Legs	03, 08	1 ea
6608 ▲	6 ft Six★Star Youth with Legs only	03, 05, 08	1 ea
6620 ▲	4 ft Six★Star Tray Slide (fits 6605)	01, 03, 08	1 ea
6621 ▲	6 ft Six★Star Tray Slide (fits 6606, 6608, 6611)	01, 03, 05, 08	1 ea
6625 ▲	Six★Star End Shelf (fits all Six★Star Food Bars)	01, 03, 05, 08	1 ea

NSF Listed products are designated with a ▲ and may be prefixed with an N

Note: 6621 can ship UPS/FedEx Ground at oversize cost; 6600, 6601, 6608, 6611, 6605, 6606 cannot ship UPS/FedEx Ground

Note: 6600, 6601 tabletop units cannot be converted to portable units



FOOD BARS & ACCESSORIES

Set up a counter top buffet pasta or salad station at your next event.
Perfect for happy hour in the bar!

Five★Star™ Buffet Bars

- Thick polyurethane foam insulation holds ice for hours
- Great with crocks, bowls or icing down beverages
- Drain plug at end of unit
- NSF Listed



7670 with 9720 Sneeze Guard

Find replacement parts at www.carlislefsp.com/replacement-parts



Prod No	Description	Color	Pack
Five★Star Buffet Bars			
7670 Δ	4 ft Five★Star Buffet Bar	01, 03, 08	1 ea
7671 Δ	6 ft Five★Star Buffet Bar	01, 03	1 ea
Free Standing Single-Sided Sneeze Guards			
9148 Δ	48" Standard Single-Sided	03, 07	1 ea
9160 Δ	60" Standard Single-Sided	03, 07	1 ea
9172 Δ	73.25" Standard Single-Sided	03, 07	1 ea
9224	24" Adjustable Single-Sided	03, 07	1 ea
9248	48" Adjustable Single-Sided	03, 07	1 ea
9260	60" Adjustable Single-Sided	03, 07	1 ea
9272	73.25" Adjustable Single-Sided	03, 07	1 ea
Free Standing Double-Sided Sneeze Guards			
9710	48" Standard Double-Sided	03	1 ea
9712	73.25" Standard Double-Sided	03	1 ea
9720	48" Adjustable Double-Sided	03	1 ea
9722	73.25" Adjustable Double-Sided	03	1 ea
Sneeze Guard Accessories			
9051	Single End Panel (encloses side area on Single Sneeze Guard)	07	1 pr
9052	Double End Panel (encloses side on Double-Sided Sneeze Guard)	07	1 ea

NSF Listed products are designated with a Δ and may be prefixed with an N

Sneeze guards not recommended for use with steam tables

Shipping Notes: 7671 cannot be shipped UPS/FedEx Ground; 7670 can ship at oversize cost

9160, 9172, 9260, 9272, 9712 cannot be shipped UPS/FedEx Ground; 9148, 9248, 9710, 9720 can ship at oversize cost



Sneeze Guards

- Designed to fit Five★Star Buffet Bars
- 9148, 9160, 9172 are NSF Listed



9260



9148

Pastry Display Cases

- Display pies, cookies, and cakes
- Slide-in trays are textured to resist scratching
- Made of sanitary, easy-to-clean acrylic
- Convenient hinged door with magnetic closure



SPD303KD



Clear(07)

Prod No	Description	Color	Pack
Pastry Display Cases			
SPD300	Three Tray (Back Door)	07	1 ea
SPD300KD	Three Tray (Back Door) (unassembled)	07	1 ea
SPD303	Three Tray, Self Serve Front & Back Door	07	1 ea
SPD303KD	Three Tray, Self Serve Front & Back Door (unassembled)	07	1 ea
SPD123	Tray Only	07	1 ea

NSF Listed products are designated with a **Δ** and may be prefixed with an N

Pastry Display Cases listed above can be shipped UPS/FedEx Ground at oversize cost with the exception of SPD123 shipping at standard rate



CONDIMENT SOLUTIONS

Packet Racks

- Packet Racks hold all types of condiment packets, utensils, straws, napkins, and take up very little counter space
- Choose between a sturdy aluminum frame or an economical chrome wire frame
- Durable plastic containers have a drop-in card holder molded into the front
- Unit comes with a set of 31 common label cards for organizing and identifying contents
- For use on counter, or mount to wall with screws (included)



381206LG



381109LG

Food Stations

Condiment Food Station

- 10806 Condiment Station includes (4) sixth-size 6" deep, StorPlus™ polycarbonate black food pans
- Can also hold (4) sixth-size Coldmaster® standard food pans sold separately on page 111



10806

10807

Multi-Purpose Food Station

- 10807 Multi-Purpose Station includes (4) third-size 4" deep, StorPlus™ polycarbonate black food pans
- Can also hold (4) third-size Coldmaster® standard food pans sold separately on page 111

Standard Pump Kit

- 38310 Includes Standard Pump and the following 5 lid sizes: 1.5", 4.31", 4.31"SP, 4.69", and 6.31"
- Pump and lid sets screw or snap on allowing you to pump condiments directly from their containers
- Standard Plastic Pump has 2 restrictor clips for dispensing either .5 or 1 ounce portions



38310

Find replacement parts at
www.carlislefsp.com/replacement-parts

Black(03)

Prod No **Description**

Color

Pack

Packet Racks

381109LG	Aluminum Packet Rack, comes with 9 ea 3.5 qt containers	—	1 ea
381206LG	Wire Packet Rack, comes with 6 ea 4 qt containers	—	1 ea

Food Stations

10806	Condiment Food Station (includes 4ea Sixth Size Food Pans)	03	1 ea
10807	Multi-Purpose Food Station (includes 4ea Third Size Food Pans)	03	1 ea

Standard Pump Kit

38310	Standard Pump Kit	—	6 ea
-------	-------------------	---	------



Carlisle topping rails, made of long lasting stainless steel, are perfect for dispensing condiments, dressings and sauces.

Standard Topping Rails

- Economical Standard Plastic Pump comes with 2 restrictor clips for dispenses either .5 or 1 ounce portions
- Removable pumps and jars included
- Rubber feet protect counter and slipping



Insulated Topping Rails

- Insulated unit combines with reusable ice packs to keep condiments chilled for hours
- Includes reusable ice packs, 2 quart containers, pumps, and self-adhesive labels of most popular condiments
- 2 quart containers include snap-on lids for overnight storage
- Choose between patented* Stainless Steel Pump or economical Standard Pump
- Stainless Steel Pump dispenses 1.25 ounces per stroke; Standard Pump dispenses .5 or 1 ounce portions



High Volume Condiment Pumps

- Holds gallon jars or #10 cans for clean look
- Choose between patented* Stainless Steel Pump or Fixed Nozzle Pump
- Stainless Steel Pump dispenses 1.25 ounce per stroke; Standard Pump dispenses .5 or 1 ounce portions



Find replacement parts at www.carlislefsp.com/replacement-parts

Prod No	Description	Color	Pack
Standard Pump Topping Rails			
38502	Topping Rail with 2 ea Standard Pumps & Jars	—	1 ea
38503	Topping Rail with 3 ea Standard Pumps & Jars	—	1 ea
38504	Topping Rail with 4 ea Standard Pumps & Jars	—	1 ea
Insulated Topping Rails			
386230IB	Insulated Topping Rail with 3 ea Stainless Steel Pumps & 2 Large Ice Packs	—	1 ea
386231B	Insulated Topping Rail with 3 ea Standard Pumps & 2 Large Ice Packs	—	1 ea
High Volume Condiment Pumps			
386010	High Volume Condiment Pump with Stainless Steel Pump	—	1 ea
38601	High Volume Condiment Pump with Fixed Nozzle Pump	—	1 ea

*US Patent Nos. 6343720, 6019256, 6450373



CUP & LID DISPENSERS

Adjustable Cup Dispensers

- One dispenser to fit all standard sizes of foam, paper, or plastic drink cups from 8 to 48 ounces
- Vertical Cabinet Models are made of rugged stainless steel
- Spring-loaded with silicone release gaskets
- Comes with four interchangeable gaskets per tube (small, medium, large, and extra large)
- No tools required; ready to use



38800GLC



38882G

38883G



38884G



38850GEW mounts directly into counter tops or walls (can be inserted into an existing template)



38820C



38830C

Gravity Feed Cup Dispensers

- Adjusts easily to fit various sizes of foam, paper, or plastic cups
- Mounts on walls and includes 2-piece quick-release side mount bracket

Prod No	Description		Pack
Adjustable Cup Dispensers			
38882G	2 Cup Dispenser, Vertical Cabinet Model	—	1 ea
38883G	3 Cup Dispenser, Vertical Cabinet Model	—	1 ea
38884G	4 Cup Dispenser, Vertical Cabinet Model	—	1 ea
38850GEW	Cup Dispenser only	—	1 ea
Gravity Feed Cup Dispensers			
38820C	Small Cup Dispenser, holds 6-11 oz, 2.5" - 3.44" cups	—	1 ea
38830C	Large Cup Dispenser, holds 12-24 oz, 3.38" - 3.88" cups	—	1 ea



Lid & Condiment Organizer

- Stainless Steel Organizer mounts on top of Vertical Cup Dispenser Cabinets or can be used on counter tops
- Rubber feet prevent slipping and protect counter
- Includes (2) pint & (3) quart plastic inserts



38800GLC

Counter Top Lid & Straw Dispenser

- Dividers adjust to accommodate all standard size lids
- Straw panel is removable for additional lid storage
- Rubber feet protect counter tops
- Dispenser can be wall mounted on two standard key-lock holes



388804L

6-Compartment Condiment Caddy

- Compact 8" x 14" size fits counter tops and coffee cabinets with limited space
- Stepped design with deep compartments for organizing condiments
- Durable ABS plastic with textured finish hides scratches



10828

Dispensers

- Sliding tops for easy loading

Toothpick Dispenser

- Holds standard box of toothpicks
- Security cable prevents theft

Straw Dispenser

- Holds a full box of regular or jumbo unwrapped straws up to 8.5" long
- Easy turn knob dispenses one straw at a time



TP100

SSD100

Find replacement parts at www.carlislefsp.com/replacement-parts



Prod No	Description	Color	Pack
Lid & Condiment Organizer			
38800GLC	Lid/Condiment Organizer	—	1 ea
Counter Top Lid & Straw Dispenser			
388804L	4 Station Counter Dispenser	—	1 ea
6-Compartment Condiment Caddy			
10828	6-Compartment Coffee Service Condiment Caddy	03	12 ea
Dispensers			
TP100	Toothpick Dispenser	07	1 ea
SSD100	Straw Dispenser	07	1 ea



BEVERAGE SERVICE

Perfect for value restaurants and cafeterias!

TrimLine™ Rectangular Beverage Dispensers

- Sleek rectangular design saves valuable counter space
- Quart and liter capacity indicators on both sides
- Reservoir has ergonomic handles for a secure grip
- Features textured lid and base
- Hingeless lid minimizes breakage and helps prevent spills
- Removable Drip Tray prevents spills and saves on clean-up time
- Choose super tough crystal clear polycarbonate or economical translucent polypropylene
- Premium Dispenser has deluxe, no-drip, locking faucet
- Economy Dispenser has industry standard, no-drip faucet
- Includes labels: Fruit Punch, Iced Tea, Lemonade, Sweetened Tea, and Unsweetened Tea



10857

Find replacement parts at www.carlislefsp.com/replacement-parts



Prod No	Description	Color	Pack
TrimLine Single Base – Compact 8" width (Includes 1 ea 3 gal dispenser)			
10850 Δ	3 gal Premium (PC) Single Base	03, 69	1 ea
10854 Δ	3 gal Premium (PPY) Single Base	03, 69	1 ea
10852 Δ	3 gal Economy (PC) Single Base	03	1 ea
10856 Δ	3 gal Economy (PPY) Single Base	03	1 ea
TrimLine Double Base – Compact 15.5" width (Includes 2 ea 3 gal dispensers)			
10851 Δ	3 gal Premium (PC) Double Base	03	1 ea
10853 Δ	3 gal Economy (PC) Double Base	03	1 ea
10857 Δ	3 gal Economy (PPY) Double Base	03	1 ea

NSF Listed products are designated with a Δ and may be prefixed with an N



10850



2229

10820

Square Beverage Dispenser

- Spring action faucet provides fast flow and dripless service

Round Beverage Dispensers

- Embossed measuring lines in 1-quart increments
- Dispensers and base sold as a unit or dispenser sold separately
- Includes labels for Iced Tea, Lemonade, Fruit Punch, Sweetened and Unsweetened Tea



Prod No	Description	Color	Pack
Square Beverage Dispenser			
10820	3 gal Square (Translucent PPY) Dispenser with Base	03	1 ea
Round Beverage Dispensers With Base			
2230	5 gal Round (White PE) Dispenser with Base	01	1 ea
2229	5 gal Round (Translucent PPY) Dispenser with Base	01, 03	1 ea
2227	3 gal Round (Translucent PPY) Dispenser with Base	01	1 ea
Round Beverage Dispensers			
2210	5 gal Round (White PE) Dispenser	02	1 ea
2209	5 gal Round (Translucent PPY) Dispenser	30	1 ea
2219	3 gal Round (Translucent PPY) Dispenser	30	1 ea



CARLISLE
FOODSERVICE PRODUCTS

EFFICIENT STURDY INNOVATIVE SANITARY **BAR SUPPLIES**

Carlisle's extensive line of bar supplies enable your serving team to operate a more efficient and profitable bar operation with consistent quality for your patrons. Our efficient, time-saving Bar Essentials, Store 'N Pour containers, and caddy systems save you time and money.





MAXIMIZER™ PORTABLE BAR

Delight your guests and increase revenue. Maximizer enables you to give your guests the bar service they want and expect. It's great for anything from banquet rooms and hotel lobbies to poolside bars and terrace dining.

Ergonomic 2-step bar and countertop is designed for ease of drink preparation and serving; large surface area keeps condiment caddies within reach without blocking the prep area.

Maximizer Portable Bar

- Maximizer offers all the style and features you expect in a premium bar at a very affordable price
- Large 56" serving area keeps condiment caddies within reach without blocking prep area
- Durable solid molded countertop is easy to clean and includes a convenient molded-in bar mat well
- Sturdy 5" non-marking swivel casters with locking brake on each end hold the bar securely in place during use
- 15-gallon ice bin features an integrated drain and water trap
- Ice bin includes a standard dust cover for sanitary storage and transport
- Fully assembled, no tools necessary
- Find replacement parts at www.carlislefsp.com/replacement-parts

Maximizer Cover

- Protective 8 gauge vinyl cover keeps bar clean and dry when not in use
- Double vented back secures with hook and loop tape for a custom fit
- Tape fastening allows easy access to bar storage area without removing cover

See our money saving coupon online at www.carlislefsp.com/ecoupons

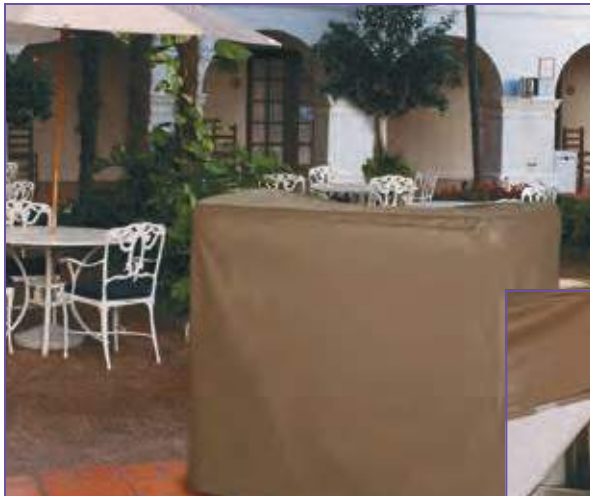

7555 Protective vinyl cover keeps bar clean and dry when not in use



Vented back for easy access

Designed by bartenders, Maximizer Portable Bar's upscale styling fits in any setting to enable profitable, efficient bar offerings that delight your guests with their favorite libations.



Maximizer Portable Bar's upscale styling is at home in any setting



Durable Maximizer Portable Bar is perfect for outdoor service



Built in cutting board for easy condiment preparation; can be removed for thorough cleaning



Storage compartment includes molded-in rails; use with StorPlus™ 12" x 18" Food Storage Boxes



Includes standard 22" Stainless Steel Speed-Rak™; holds 6 bottles or 6 Store 'N Pour® Quart containers



Unique sliding storage drawer accommodates mixers, sodas, or standard bus boxes and can be removed for more versatile storage



Large storage area under the drawer is perfect for staging glassware using our OptiClean™ Glass Racks

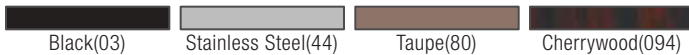

Prod No	Description	Color	Pack
7550	Maximizer Portable Bar	03, 44, 094	1 ea
7555 ▼	Maximizer Bar Cover	80	1 ea

Find replacement parts at www.carlislefsp.com/replacement-parts

Note: 7550 cannot ship UPS/FedEx Ground

WARNING: Products identified on this page with the following ▼ symbol contain chemicals, including one or more phthalates, known to the State of California to cause cancer and birth defects and other reproductive harm.

STORE 'N POUR®

Store 'N Pour

- Enjoy the benefits of the most efficient storing and pouring system for the bar, kitchen, or dining room
- Pour a perfect 2-1 drink every time with the patented vented spout design
- Two-piece spout and neck design for easy cleaning
- Exclusive manufacturing process ensures tight seal with no leaks
- Made of high density, break-resistant polyethylene
- Easy clean containers have straight wall design with no sharp interior edges that can collect food or bacteria
- Unique stacking ridge on quart and pint caps make storage on shelf in refrigerator easy and secure
- Color-coordinated spouts and caps for easy product identification
- Lids snap on exclusive, recessed base of pints and quarts to prevent loss
- Assorted cap colors promote color-coding



Back of House Store 'N Pour

Our Store 'N Pour bottles and pourers can also be used in back of the house applications:

- Holding and pouring spices
- Cooking wine/sherry storage and usage

PourPlus™ PourPlus Complete

- Complete unit includes container, lid, and spout

PourPlus Spout

- PourPlus fits all Store 'N Pour containers
- Integrated neck and spout designed for fast, free flowing pouring and easy clean-up
- Textured neck provides sure grip—even when wet
- Necks are color-coded



Store 'N Pour Versatility



Front-of-the-house use



Perfect 2-1 drinks are easy



Stackable backup storage



Back-of-the-house use



Pour batters and oils

Find replacement parts at www.carlislefsp.com/replacement-parts



Prod No	Description	Color	Pack
Store 'N Pour Speed Spout			
3042	Speed Spout	07	24 ea
Pour Plus Store 'N Pour			
PS204	PourPlus Spout	02	12 ea
PS204AST*	PourPlus Spout, Assorted	00	1 set
PS601NC	Quart Complete	00, 02	12 ea

*Assorted PourPlus quart packs include 2 each of all colors; half-gallon and gallon assorted packs includes 1 each of all colors

The Essential Drink Mix System



1. Mix In One-Gallon Container

Accurately measure and mix concentrate or powder in gallon containers. Its wide mouth eliminates the need for a funnel.



2. Cut Preparation Time

Prepare mixes and juices in advance using the gallon storage container. At peak periods simply empty into a quart backup.



3. Transfer To Quarts

Pour a gallon of mix into four easy-to-handle quart containers.



4. Ready To Use

Attach neck with spout to one quart for use in speed rack. Cap the remaining three quarts for backup.

Store 'N Pour Complete Units & Backups

- Complete unit includes neck and container plus color-coordinated pouring spout and cap
- Backup unit includes cap and container
- Dishwasher safe

Store 'N Pour Speed Spout

- No-drip spout is vented to promote faster, more even flow



3042



Store 'N Pour Bar Service Pack

Includes six quart complete units (container, neck, and color-coordinated spout and cap), 18-quart backup units (container and cap) and 1-gallon backup unit (container with cap) for mixing



Assorted(00)	Brown(01)	White(02)	Yellow(04)
Red(05)	Clear(07)	Green(09)	Orange(24)

Prod No	Description	Color	Pack
Store 'N Pour Complete Units & Backups			
PS501N	Pint Complete	00	12 ea
PS502N	Pint Backup	00	12 ea
PS601N	Quart Complete	00, 01, 02, 04, 05, 09, 24	12 ea
PS602N	Quart Backup	00, 02, 05	12 ea
PS701B	Half-gallon Complete	00	6 ea
PS702	Half-gallon Backup	00	6 ea
PS801B	Gallon Complete	00	6 ea
PS802	Gallon Backup	00	6 ea
PS103	Spouts, Specify Color	01, 04, 05, 07, 24	12 ea
PS103AT	Spout Assortment, 2 ea color	00	12 ea
PS203	Necks	02	12 ea
PS304	Caps, Specify Color	01, 02, 04, 05, 24	12 ea
PS304AT	Caps, Assortment, 2 ea color	00	12 ea
PS603N	Quart, Container Only	02	12 ea
Store 'N Pour Bar Service Pack			
PS6012	Store 'N Pour Bar Service Pack	00	1 set
Store 'N Pour Speed Spout			
3042	Speed Spout	07	24 ea

*Assorted PourPlus quart packs include 2 each of all colors; half-gallon and gallon assorted packs includes 1 each of all colors



BOTTLE HOLDERS & CONDIMENT CADDIES

Stainless Steel Speed-Rak™ Bottle Holders

- Keyhole slots make installation and cleaning easy
- Mounts to bar sink with screws (provided)
- Unique design; single Speed-Raks can be combined to make a double-hung unit



38322BH
Combine to make a
double-hung unit

Find replacement parts at
www.carlislefsp.com/replacement-parts

Prod No	Description	Color	Pack
Stainless Steel Speed-Rak Bottle Holders			
38322BH	22" Speed-Rak, holds (5) 1-liter bottles	—	2 ea
38332BH	32" Speed-Rak, holds (8) 1-liter bottles	—	2 ea
38342BH	42" Speed-Rak, holds (10) 1-liter bottles	—	2 ea



Condiment Caddies

Stainless Steel Caddies

- Rugged stainless steel construction for years of use
- Full size hinged lid units protect condiments from spills and contaminants
- Individual compartment lids keep contents covered when not in use
- Notched lid models available for use with spoons or ladles
- Sanitary pint & quart inserts are easy to clean; (2) pints interchange with (1) quart, allowing you to mix and match to suit your needs



38704CSIB

Stainless Steel Iced Caddies

- Insulated caddies use ice packs to keep condiments chilled and cold for hours without ice or electricity

Deluxe Caddies

- Solid frosted cover
- Includes caddy and individual containers

Plastic Caddies

- Solid frosted cover
- Includes caddy and individual containers



CH03



SS105



Prod No	Description	Color	Pack
Stainless Steel Condiment Caddies			
38704CNS	4 qt Condiment Caddies with 4 Lids	—	1 ea
38704CSIB	4 qt Condiment Caddies with 4 Notched Lids & 4 Ice Packs	—	1 ea
38704C	4 pt Condiment Caddies with One-Piece Lid	—	1 ea
38705C	5 pt Condiment Caddies with One-Piece Lid	—	1 ea
38706C	6 pt Condiment Caddies with One-Piece Lid	—	1 ea
Plastic Condiment Caddies			
SS105	Caddy with 5 ea 1.25 Pint Containers/Lids	02	1 ea
CH03	Deluxe Condiment Caddy with 6 ea Pint Containers	03	1 ea
CH15	Deluxe Condiment Caddy with 4 ea 1.5 Pint Containers	03	1 ea

BAR ACCESSORIES

Bar Caddy

- Ideal bar-top holder that allows quick access to cocktail napkins, stirrers, and other accessories
- Break-resistant plastic



Store 'N Pour® Condiment System

- Condiment system includes tray with cover and six pint containers (PS502N) with assorted caps
- Assorted color caps provide easy identification; caps snap on the bottom for easy storage
- Acrylic covers protect condiments during service



Prod No	Description	Color	Pack
Bar Caddy			
BC05	Bar Caddy	03	12 ea
Store 'N Pour Condiment System			
PS101CS	Complete Condiment System	00	2 ea

Bar Mat & Service Mat

- Non-slip mats help keep counter tops clean
- Molded-in pattern provides drainage for spilled drinks and wash downs with a sure grip for wet glassware
- Bar Mats have drainage area for jigger, main area holds up to six glasses

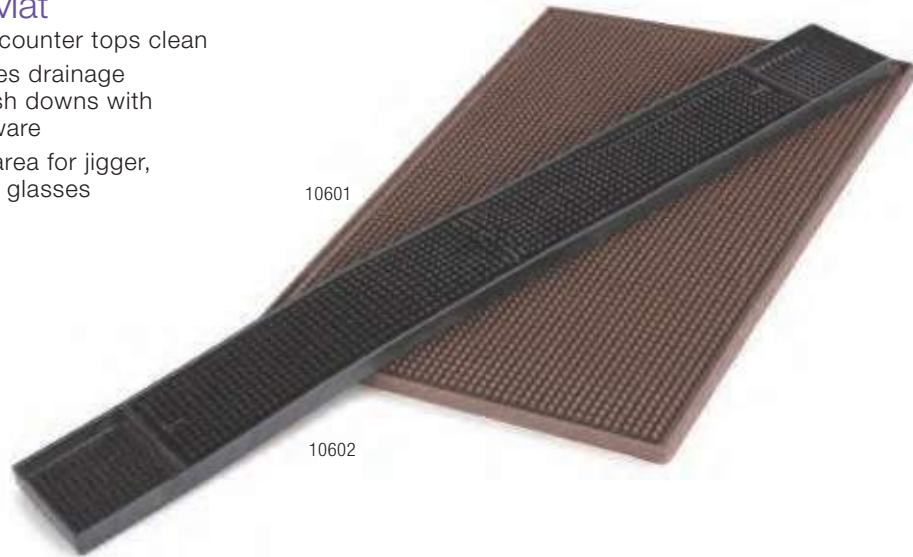

Bar & Shelf Liner

- Provides skid-resistance and high impact absorption; net pattern allows thorough drainage, promoting rapid, fog-free drying
- Helps prevent bacteria growth
- Resistant to food acids, grease, and detergents; conforms to FDA regulations
- Constructed of a firm, resilient plastic



Prod No	Description	Color	Pack
Bar Mat & Service Mat			
10601	12" x 18" Service Mat	01, 03	6 ea
10602	3" x 27" Bar Mat	01, 03	12 ea
Bar & Shelf Liner			
3210	2' x 40' Texliner Roll	01, 03, 07	1 ea
3211	2' x 10' Texliner Roll	03, 07	1 ea



BAR ACCESSORIES

Glass Rimmers

Standard Glass Rimmer

- Two-tier unit provides consistent and even coat of salt

Combination Salt/Sugar Glass Rimmer

- Three-tier unit allows for application of either salt or sugar



Portion Control Liquor Pourers

- Carlisle offers portion control pourers in both ounce and metric measurements
- Classic design Portion Pour dispenses exact shots of liquor

Portion Pour®

- Portion Pour dispenses exact shots of liquor from 1 to 1.5 ounce
- Also available in 20ml metric size



Prod No	Description	Color	Pack
Glass Rimmers			
GR09	3-Tier Glass Rimmer	03	12 ea
GR10	2-Tier Glass Rimmer	03	12 ea
Portion Control Liquor Pourers With Red Spout/Black Collar			
EP214	1 oz Portion Pour with Red Base	00	12 ea
EP215	1.13 oz Portion Pour with Purple Base	00	12 ea
EP216	1.25 Portion Pour with Clear Base	00	12 ea
EP217	1.5 oz Portion Pour with Yellow Base	00	12 ea
Metric Portion Control Liquor Pouter With Red Spout/Black Collar			
EP320	20 ml Portion Pour with Black Base	00	12 ea

Pour Free®

- Economical Pour Free for free-flow pouring



OP371, OP304

Free Flowing Metal Liquor Pourers

- Sturdy metal construction and choice of three flow rates
- Chrome plated for attractive appearance and longer life

Pourer With Screen

- Metal style pourer with sanitary screen



Prod No	Description	Color	Pack
Pour Free			
OP304	Sparkle Red Pour Free	00	12 ea
OP305	Fluorescent Red Pour Free	00	12 ea
OP311	Blue Pour Free	00	12 ea
OP314	Clear Pour Free	00	12 ea
OP316	Black Pour Free	00	12 ea
OP371	Chrome/Black Collar Pour Free	00	12 ea
OP373	Clear/Black Collar Pour Free	00	12 ea
Metal Style Free Flowing Pourers			
WPM25	Chrome Tapered with Screen	38	12 ea
WPM85	Chrome Tapered, Medium Flow	38	12 ea
WPM20	Chrome Straight, Fast Flow	38	12 ea
WPM45	Chrome Angled, Super Fast Flow	38	12 ea



BAR ACCESSORIES

Cocktail Shaker

- Bar Essential 18-8 mirror polished all stainless steel classic 3-piece shaker (608600) has a vented pour spout that reduces splashing and spills
- Units fit together snugly for no-mess shaking



608600

Bar Essential™ Bar Accessories Shaker

- Bar Essential 18-8 heavy-duty shaker (608530) features sturdy one-piece construction; ultra smooth interiors won't scratch or chip mix glasses



608530

Bar Spoon

- Heavy-duty bar spoon is perfect for hand mixing drinks
- 18-8 stainless steel won't rust like economy spoons
- NSF Listed; dishwasher safe



608212

Wine Servers & Coolers

Double Walled Wine Coolers

- Double walled construction keeps bottles chilled for hours (no need to pre-chill cooler or use ice)
- Prevents damaging surface condensation
- 18-8 stainless steel is more durable than marble coolers; never requires polishing
- Choose satin or mirror polish finish
- 609144 and 609145 also accommodate champagne bottles
- Hand wash only



609143



609144



609145

Prod No	Description	Color	Pack
Cocktail Shakers			
608600	30 oz Classic Cocktail Shaker	—	12 ea
Bar Essential Bar Accessories			
608530	30 oz Bar Essentials Bar Cup	—	12 ea
608212 Δ	11.25" Heavy-Duty Bar Spoon	—	24 ea
Double Walled Wine Servers & Coolers			
609143	Double Wall Wine Cooler, Satin Finish with Mirror Finish Rim; 7.75" H	—	1 ea
609144	Double Wall Wine Cooler, Satin Finish with Mirror Finish Rim; 8.75" H	—	1 ea
609145	Double Wall Wine Cooler, Mirror Finish, 8.75"H	—	3 ea

NSF Listed products are designated with a Δ and may be prefixed with an N

Wine Buckets & Stands

- Wine buckets and stands enhance any fine dining experience
- Choice of standard or double size wine bucket
- Stands are 24" high with heavy, weighted bases to prevent accidental tipping
- 18-8 stainless steel never requires polishing
- Mirror polish finish, hand wash only



609107



609110

609146



609109

609147

Prod No	Description	Color	Pack
Wine Buckets & Stands			
609107	Wine Bucket (fits 609146)	—	4 ea
609109	Magnum Deluxe Wine Bucket (fits 609147)	—	1 ea
609110	Allegro Wine Bucket (fits 609146)	—	1 ea
609146	24" Wine Bucket Stand; 7.5" Dia	—	1 ea
609147	24" Wine Bucket Stand; 8.5" Dia	—	1 ea

NSF Listed products are designated with a Δ and may be prefixed with an N



BAR ACCESSORIES

Wine Server

- Wine Servers merchandise your wine selection
- Double-wall construction provides insulation to help keep wine at proper temperatures



Red Wine Holder

- Satin finish 18-8 stainless steel never requires polishing
- Two rings orbit above the base to create an easy carry handle; bottles snap into handle for secure pouring
- Hand wash only



Acrylic Ice Buckets

- Can also be used for chilling wine
- Diamond Cut Bucket has chrome-plated lid and side handles
- Wine/Ice Bucket has attractive pebbled finish in clear acrylic



Prod No	Description	Color	Pack
Acrylic Wine Servers			
IG224	Acrylic Server with Black Base	03	12 ea
Red Wine Holder			
609106	Red Wine Holder	—	1 ea
Acrylic Ice Buckets			
IG1011	Wine/Ice Bucket with Handle	—	4 ea

Ice Buckets

- 18-8 stainless steel never requires polishing
- Double walled construction (609190, 609193) holds ice longer and prevents surface condensation
- 609190 has flat handle, hinged lid and comes complete with perforated drain tray and tong
- 609191 has mirror polished finish outside, satin finish inside, with knob handles
- 609193 has tubular handle and satin finish; complete with lid
- Hand wash only



609190



609193



609191

Ice Scoops

- 606106 scoop is made of 18-8 rust-free mirror polished stainless steel
- 4306 is made of durable polycarbonate material for long lasting use
- Tapered for easy pouring of ice into glasses
- Both feature a hole for hanging or tying to a container
- Made of durable polycarbonate material for long-lasting use
- See page 197 for a complete listing of Carlisle's scoop line
- NSF Listed; dishwasher safe



606106

4306



Clear(07)

Prod No	Description	Color	Pack
Stainless Steel Ice Buckets			
609190	1.5 qt Double Wall Ice Bucket with Tong	—	1 ea
609193	3.5 qt Double Wall Ice Bucket	—	1 ea
609191	1.7 qt Ice Bucket with Handle and Tong	—	1 ea
Ice Scoops			
606106 Δ	6 oz Stainless Steel Bar Scoop	—	24 ea
4306 Δ	6 oz Polycarbonate Scoop	07	12 ea

NSF Listed products are designated with a Δ and may be prefixed with an N



PRACTICAL
ELEGANT
RUGGED
DURABLE
**FOODSERVICE
TRAYS**

Carlisle trays and accessories are designed to please your patrons and enable your staff to serve meals economically without sacrificing durability.

We set the standard for size, color selection, appearance and reliability.



GLASTEEL™ TRAY COLOR SAMPLES

Solid Colors





BOX INDICATES
AVAILABLE FOR
IMMEDIATE
SHIPMENT
IN
SELECT
SIZES

Solid Colors (cont.)



Mulberry



Rainforest Green



Mauve



Slate Blue



Gray



Raspberry



Coffee Tan

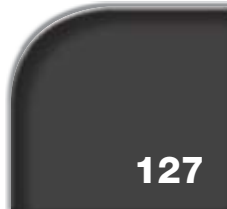

Chocolate



Pacific Blue



Bay Leaf Brown



Cherry Red



Primrose Yellow

Decorative Patterns



Starfire Gray



Starfire Blue



Starfire Natural



Starfire Beige

Wood Grain Patterns



Pecan



Light Oak



Butcher Block



Redwood



FIBERGLASS TRAYS

Glasteel™ Trays

Glasteel trays offer durability and cleanability at an affordable price.

- Engineered to be the most durable fiberglass trays available
- Decorating option, see page 330-331 for additional information
- 5-year limited warranty
- NSF Listed; dishwasher safe

Heavy-Duty Construction

- Metal reinforcing rods provide extra strength and eliminate warping
- Two thick, reinforcing fiberglass core mats add strength and provide increased chemical resistance

Air Flow Corner Reinforcements

- Air flow corner reinforcements and stacking lugs make Glasteel trays your best choice for stability and drying when stacked
- Unique design permits air flow to all surfaces of stacked trays, reducing drying time

Fiberglass Trays are available in full cases only.
There is a NO-RETURN POLICY on Fiberglass Trays.



Custom Decorating

Carlisle offers a decorating program so you can label your trays with a logo, image or any graphic

Trapezoid

Space saving shape for better table fit



Image Wrap

Full color images printed on both sides of the tray*



Rectangular Regular & Low-Edge

Low-edge trays have “squared-off” corners to permit dish overhang, fitting more serving items on a given tray size



Display/Bakery

Ideal for displays and available in all colors and patterns



*Additional charges will apply.



Available for immediate shipment in Bone White(001), Natural(003), Black(004), & Almond(095)



Dimensions & Weights For Use With Self-Leveling Dispensers

Prod No	Length	Width	Height of One	Height of 11	Weight of 10
1410FG	13-3/4"	10-5/8"	3/4"	3-5/16"	9lb 2oz
1612FG	16-3/8"	12"	3/4"	3-5/16"	11lb 12oz
1814FG	18"	14"	3/4"	3-1/2"	14lb 4oz
2015FG	20-1/4"	15"	3/4"	3-5/16"	17lb
2216FG	22"	16"	1-1/8"	4-1/8"	21lb 8oz
1713FG	18"	14"	3/4"	3-1/2"	14lb 12oz
2214FG	22"	14"	3/4"	3-5/16"	15lb 2oz

Trapezoid Tray Table Planner

	1713	2214
36" Square Table Holds	4 ea	4 ea
42" Round Table Holds	4 ea	4 ea
54" Square Table Holds	6 ea	6 ea

Prod No	Description	Pack
Solid Color	Decorative Pattern	Wood Grain
Rectangular		
1410FG Δ	1410DFG Δ	1410WFG Δ
1612FG Δ	1612DFG Δ	1612WFG Δ
1814FG Δ	1814DFG Δ	1814WFG Δ
2015FG Δ	2015DFG Δ	2015WFG Δ
2216FGQ Δ	2216DFGQ Δ	2216WFGQ Δ
Low Edge		
1216LFG Δ	1216LDFG Δ	1216LWFG Δ
1418LFG Δ	1418LDFG Δ	1418LWFG Δ
1219LFG Δ	1219LDFG Δ	1219LWFG Δ
1520LFG Δ	1520LDFG Δ	1520LWFG Δ
1222LFG Δ	1222LDFG Δ	1222LWFG Δ
Display/Bakery		
269FG Δ	269DFG Δ	269WFG Δ
1318FG Δ	1318DFG Δ	
2618FGQ Δ	2618DFGQ Δ	2618WFGQ Δ
Trapezoid		
1713FG Δ	1713DFG Δ	1713WFG Δ
2214FG Δ	2214DFG Δ	2214WFG Δ
Metric		
2310FG Δ	2310DFG Δ	2310WFG Δ
1220FG Δ	1220DFG Δ	1220WFG Δ
1212FG Δ		1212WFG Δ
2115FG Δ	2115DFG Δ	2115WFG Δ
1419FG Δ	1419DFG Δ	1419WFG Δ

NSF Listed products are designated with a Δ and may be prefixed with an N
See corresponding covers on page 158



SPECIALTY TRAYS

Carlisle offers a **broad assortment** of shapes, and colors to ensure all your tray needs are met.

Fiberglass Market Trays & Pans

- Use for displaying breads, bakery items, and sliced deli meat
- 2" deep pans for serving deli salads, pasta, and desserts
- Trays have heavy-duty fiberglass construction and metal reinforced rods
- Air-flow corners reduce drying time
- NSF Listed



Polycarbonate Tray

- Designed for use in correctional facilities, schools, and other demanding foodservice applications
- Will not break or shatter and have a textured, scratch-resistant finish
- Five-year warranty against breakage saves you money
- They provide rigidity and durability without metal reinforcement rods
- Resistant to food acids and oils and safe for use in temperatures of -40°F to 212°F
- 5-year limited warranty
- NSF Listed; dishwasher safe



Prod No	Description	Color	Pack
Fiberglass Market Trays			
630FMT Δ	30.00/6.44/0.75	309*	12 ea
830FMT Δ	30.00/8.50/0.75 Tray	301, 309	12 ea
1030FMT Δ	30.00/10.44/0.75 Tray	301, 309	12 ea
1230FMT Δ	30.00/12.44/1.05 Tray	301, 309	12 ea
269FMT Δ	8.75/25.50/1.12 Tray	301, 309	12 ea
1218FMT Δ	17.75/11.44/0.75 Tray	301, 309	12 ea
1318FMT Δ	17.75/12.75/1.00 Tray	301, 309	12 ea
2618FMTQ Δ	17.87/25.62/1.25 Tray	301, 302, 303, 304, 306, 309	6 ea
Fiberglass Market Pans			
6302FMT Δ	30.00/6.45/2.00 Pan	301, 309	12 ea
8302FMT Δ	30.00/8.45/2.00 Pan	301, 309	12 ea
10302FMT Δ	30.00/10.47/2.00 Pan	301, 309	12 ea
Polycarbonate Trays			
1418PC Δ	18.00/14.00/1.13 Rectangular Tray	25	12 ea

Available for immediate shipment—all other colors available as special order

NSF Listed products are designated with a Δ and may be prefixed with an N



Café Trays

- Feature skid-resistant surface and drying/stacking lugs
- Custom hot stamping is available, see page 330-331 for additional information
- Economical & light-weight polypropylene
- NSF Listed



CT1014

CT1216

Standard Café Tray

- Traditional scratch-resistant basket weave design reduces slipping and helps prevent accidental spills

Trapezoid Café Tray

- Space saving shape allows diners to eat directly from trays without removing plates, cups, etc. from the tray
- Promotes self-bussing



CT1217

CT1713TR

CT1216

Handled Café Tray

- Handled tray is easy to carry and offers added strength

Carlisle recommends hand washing for Café Trays

Bistro™ Trays

- Unique trays offer a great look at an economical price
- Durability and economy of our Café Trays with stylish curved handles for easy handling and added strength
- Scratch-resistant, textured design reduces slipping, helps prevent spills
- Drying and stacking lugs



1217BT

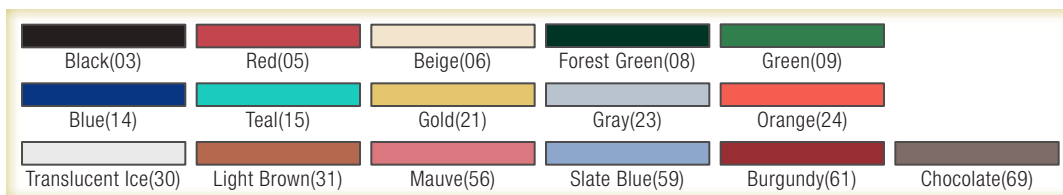

Prod No	Description	Color	Pack
Café Trays			
CT1014 Δ	13.87/10.75/0.79 Standard Tray	03, 05, 06, 08, 09, 14, 15, 23, 24, 61, 69	24 ea
CT1216 Δ	16.31/12.06/0.70 Standard Tray	03, 05, 06, 08, 09, 14, 15, 21, 23, 24, 31, 59, 61, 69	24 ea
CT1418 Δ	17.87/14.00/0.98 Standard Tray	03, 05, 06, 08, 09, 14, 15, 23, 24, 31, 59, 61, 69	12 ea
CT1713TR Δ	18.00/14.00/0.81 Trapezoid Tray	03, 06, 14, 23, 69	12 ea
CT1217 Δ	16.93/12.06/0.60 Handled Tray	03, 05, 14, 69	24 ea
Bistro Trays			
1217BT	12" x 17" Bistro Tray	03, 30	12 ea
1319BT	13" x 19" Bistro Tray	03, 30	12 ea

Available for immediate shipment

NSF Listed products are designated with a Δ and may be prefixed with an N



COMPARTMENT TRAYS

Our Compartment Trays are the perfect **cost effective solution** for portion control.

6-Compartment Trays

- The 6-compartment trays hold government "Type A" lunch
- Carlisle offers the largest variety of sizes and compartment combinations available
- All materials are FDA approved and NSF Listed



Materials

Melamine

- Melamine is a heavy, rigid material with the look and feel of china
- It is very scratch- and break-resistant
- Fast drying melamine is highly resistant to chemicals and food acids with a temperature range of 0° to 212°F

Polycarbonate

- Money saving trays carry a five-year warranty against breakage
- Highly break-resistant; perfect choice for correctional facilities
- Polycarbonate offers good scratch- and chemical-resistance with a temperature range of -40° to 212°F

Polypropylene

- Economical, durable choice
- Good chemical resistance
- Temperature range of 30° to 180°F
- Handwashing is recommended

ABS

- Break- & scratch-resistant
- Excellent choice for general use
- Highly resistant to chemicals and food acids with a temperature range of 0° to 180°F

Orientations

Left & Right-Hand

- Offer a greater variety of serving combinations
- Available in melamine, polycarbonate, ABS, and polypropylene
- NSF Listed, except when offered in Variegated(00)

Omni-Directional & Space Saver Trays

- Special design allows you to fit two trays side by side in dish rack for faster cycling time



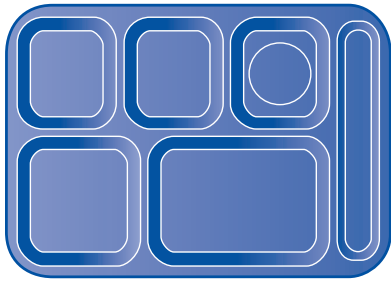

Right-Hand Tray
(43988, 43989, 614R, P614R)

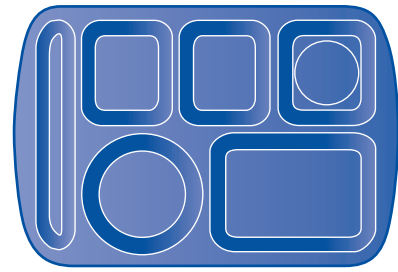

Handled Economy Left-Hand Tray
(5865)



Space-Saver Omni-Directional Tray
(615**)

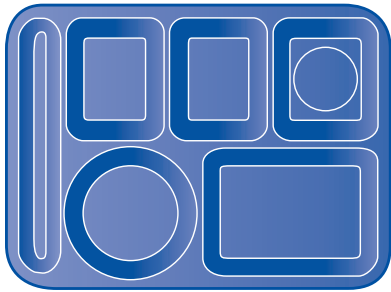

Left-Hand Tray
(43980, 43981, 614, P614, 614PC†)

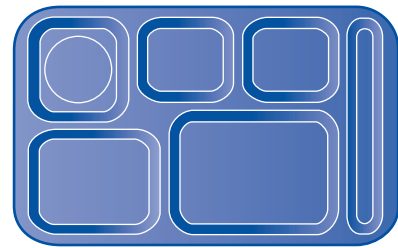

Space-Saver Right-Hand Tray
(43982, 43983)

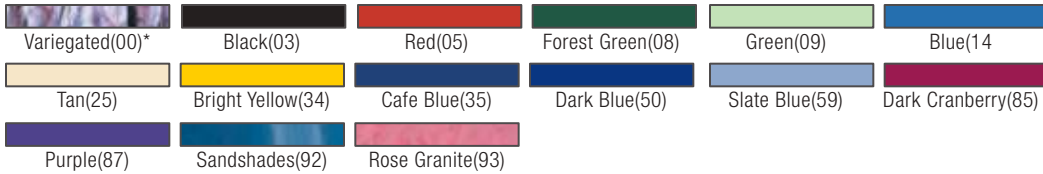

Prod No	Description	Color	Pack
Right-Hand Trays			
43988 Δ	Heavy-weight Melamine Tray	05, 08, 25, 34, 35, 50, 59, 85, 87	12 ea
43989 Δ	Heavy-weight Sandshades/ Rose Granite Melamine	00*, 92	12 ea
614R	ABS Tray	03, 05, 09, 25, 59	24 ea
P614R	Polypropylene Tray	05, 09, 14, 25	24 ea
Space-Saver Right-Hand Tray			
43982 Δ	Space-Saver Melamine Tray	05, 08, 50, 59	12 ea
43983 Δ	Space-Saver Sandshades Melamine Tray	92	12 ea
Left-Hand Trays			
43980 Δ	Heavy-weight Melamine Tray	05, 08, 25, 35, 50, 59, 85, 87	12 ea
43981 Δ	Heavy-weight Sandshades/Rose Granite Melamine	00*, 92, 93	12 ea
614PC †	Polycarbonate Tray	25	24 ea
614	ABS Tray	03	24 ea
P614	Polypropylene Tray	05, 25	24 ea
Handled Economy Melamine Left-Hand Tray			
5865	Handled Economy Melamine Tray, Variegated	00*	12 ea
Space-Saver Omni-Directional Tray			
615**	Space-Saver ABS Tray	03, 05, 14, 25	24 ea

NSF Listed products are designated with a Δ and may be prefixed with an N

*Note: Variegated(00) option is not NSF Listed

**615 is a licensed product under U.S. Patent D292, 768

† 614PC carries a 5-year warranty against breakage

Rose Granite, Sandshades, and Variegated items vary in color, hue, and intensity from piece to piece



TRAYS, COVERS & ACCESSORIES

Polycarbonate Compartment Trays

5-Compartment Trays

- 5-year warranty against breakage
- Inside compartments have a textured surface for greater scratch resistance
- 5-year limited warranty
- NSF Listed; dishwasher safe

4-Compartment Trays

- Smaller size trays are perfect for elementary schools and lunch menus
- Omni-directional KL444 and 43986 trays feature two-way stacking
- 5-year limited warranty
- NSF Listed; dishwasher safe



Compartment Tray Cover

- Help maintain food temperatures and protect food from contamination and spills
- Dishwasher safe

Pastry Tray Covers

- Clear covers offer best visibility in bakeries, delis, and convenience stores
- Sanitary covers help preserve taste and quality
- Rust-proof stainless steel hinges and screws provide long life
- Use with Carlisle trays, see pages 152-153 for corresponding trays

Carlisle Tray Guide

SC25 & SC26 fit 2618FG, 2618DFG, 2618WFG trays

SC27 & SC29 fit 1220FG, 1220DFG, 1220WFG trays

SC40 fits 1318FG, 1318DFG, 1318WFG trays

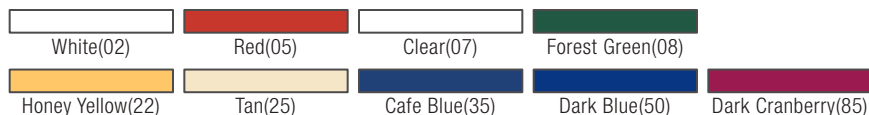

Prod No	Description	Color	Pack
5-Compartment Trays			
PCD801 ▲	5-Compartment Tray, 11.50/10.50/1.00	25	24 ea
4-Compartment Trays			
43984 ▲	4-Compartment Tray, Right-Hand, 10.11/9.79/0.51	05, 22, 50	48 ea
43986 ▲	4-Compartment Server Tray, 10.30/9.58/0.85	25, 35	36 ea
KL444 ▲	4-Compartment Tray, 10.95/8.67/0.62	08, 85	12 ea
Compartment Tray Cover			
10145	Cover Fits Non-Handled Right and Left Handed 6-Compartment Trays	02	12 ea
Pastry Tray Covers			
SC25	26" x 18" x 4" Cover	07	1 ea
SC26	26" x 18" x 4" Hinged Cover	07	1 ea
SC27	20" x 12" x 4" Cover	07	3 ea
SC29	20" x 12" x 4" Hinged Cover	07	3 ea
SC40	18" x 13" x 4" Cover	07	1 ea

NSF Listed products are designated with a ▲ and may be prefixed with an N



Room Service Trays

- 15" x 20" handled room service trays give an upscale dining experience
- Low rimmed edge keeps tray top items in place
- NSF Listed; dishwasher safe



RST1520NSQ

Tip Trays

- Standard Tip Tray and Check Holder are made of styrene
- Check Holder's handy clip keeps checks, credit cards, or cash securely in place
- NSF Listed; dishwasher safe



Money Maid™ Combo Packs

- Contains a locking coin and bill compartment, napkin holder, and utility pocket; designed to clip onto trays; see our line of GripTite2, GripLite and Cork Trays shown on pages 160-161
- Combo Packs include one Money Maid and six coin trays in a shrink-wrapped set
- Round Clip-On (1401) fits all standard 14" round trays
- Rectangular Clip-On (1030) and Coin Trays fit all 12" x 16" trays



Prod No	Description	Color	Pack
Foodservice Room Service Trays			
RST1520NSQ Δ	15" x 20" Low Profile Room Service Tray	03	6 ea
Tip Trays			
3022 Δ	Standard Tip Tray; 4.5" x 6.5"	01, 03	36 ea
3020 Δ	Check Holder Tip Tray; 4.38" x 7.75"	03	12 ea
Money Maid Combo Packs			
1401	Round Clip-On Money Maid	01	12 ea
1031	Round Money Maid Combo Pack with Six Coin Trays	01	12 ea
1030	Rectangular Money Maid Combo Pack with Six Coin Trays	01	12 ea

NSF Listed products are designated with a Δ and may be prefixed with an N



SERVICE TRAYS

Griptite™ 2

- A service tray built for the real world
- Griptite 2 trays' non-skid surface is designed to grip drinks and plates better than any existing tray
- The new surface prevents spills and is designed to look and feel like new for years
- Our new GT2 surface helps bars and restaurants with increased skid resistance to lower cost of spilled drinks, food, and possible falls
- Additional coating on sides of tray reduces wear and tear due to drops
- Improved stain resistance keeps trays looking new longer
- Heavy-duty fiberglass construction eliminates warping and breakage
- Trays are stain and odor resistant
- 5-year limited warranty
- NSF Listed; dishwasher safe



Prod No	Description	Color	Pack
Griptite 2 Trays			
1100GR2 ▲	Griptite 2 Round Tray 11.75"	004, 076	12 ea
1400GR2 ▲	Griptite 2 Round Tray 14.75"	004, 076	12 ea
1410GR2 ▲	Griptite 2 Rectangular Tray 13.81" x 10.63"	004, 076	12 ea
1600GR2 ▲	Griptite 2 Round Tray 16"	004, 076	12 ea
1612GR2 ▲	Griptite 2 Rectangular Tray 16.38" x 12.75"	004, 076	12 ea
1814GR2 ▲	Griptite 2 Rectangular Tray 18" x 14.88"	004, 076	12 ea
1826GR2Q ▲	Griptite 2 Rectangular Tray 18" x 25.75"	004, 076	6 ea
2015GR2 ▲	Griptite 2 Rectangular Tray 20.25" x 15"	004, 076	12 ea
2216GR2Q ▲	Griptite 2 Rectangular Tray 22" x 16"	004, 076	6 ea
2500GR2 ▲	Griptite 2 Oval Tray 24" x 19.25"	004, 076	6 ea
2700GR2 ▲	Griptite 2 Oval Tray 27" x 22.31"	004, 076	6 ea
3100GR2 ▲	Griptite 2 Oval Tray 31.5" x 23.5"	004, 076	6 ea
3253GR2 ▲	Griptite 2 Rectangular Tray 12.75" x 20.88"	004, 076	12 ea

NSF Listed products are designated with a ▲ and may be prefixed with an N



**GripLite®
Polypropylene**

- Economical alternative
- Made of a high density polypropylene co-polymer
- Molded-in, rubber liner prevents slipping and sliding of glasses and dinnerware
- A more sanitary alternative to cork trays
- Stain and odor resistant
- Handwashing is recommended



Cork Trays

- Durable plastic construction will not chip or dent
- Available in economical, lightweight, break-resistant polypropylene for bar service or break-resistant, sturdy ABS for heavy-duty use and greater stability
- The cork surface is bonded to the tray and treated to reduce wear and increase durability
- Replacement cork available at www.carlislefsp.com/replacement-parts
- Handwashing is recommended



Prod No	Description	Color	Pack
GripLite Trays			
1100GL	11.25/0.76 Round Tray	004, 076	12 ea
1400GL	14.63/0.76 Round Tray	004, 076	12 ea
1600GL	16.44/0.73 Round Tray	004, 076	12 ea
Cork Trays			
3014	14.00/0.75 Round Tray	01	12 ea
3016	16.00/0.75 Round Tray	01	12 ea
2419	24.00/19.00/0.75 Oval Tray	01	6 ea
2823	28.00/23.00/0.75 Oval Tray	01	6 ea
3013	13.88/0.75 Round Tray	01	12 ea
3015	15.88/0.75 Round Tray	01	12 ea

Available for immediate shipment

NSF Listed products are designated with a Δ and may be prefixed with an N



SERVING TRAYS

Celebration Trays

- Large trays are perfect for serving bread, cheeses, hors d'oeuvres, and pastries
- Economically priced trays are perfect for off site catering or buffet displays
- Sturdy and reusable, they are the perfect alternative to disposables
- Chrome-plated, mirror-polished finish never requires polishing
- Hand wash only; polish dry with soft cloth

Round



Oval



Rectangular



Octagonal



Prod No	Description	Pack
Celebration Trays		
608905	13" Round Gadroon Tray	12 ea
608907	14" Round Gadroon Tray	12 ea
608919	20.88" x 13.5" Oval Tray with Integral Handles	12 ea
608904	17.75" x 12.88" Oval Tray with Ornate Border	12 ea
608913	17.75" x 12.88" Oval Tray with Gold Border	12 ea
608918	21" x 15" Rectangular Tray with Ornate Border	12 ea
608908	18.25" x 12.38" Rectangular Tray with Gold Border	12 ea
608909	20.63" x 14" Rectangular Tray with Gold Border	12 ea
608901	17.13" x 11.75" Octagonal Tray with Beaded Border	12 ea
608902	20" x 13.75" Octagonal Tray with Beaded Border	12 ea



Festival Trays™

- Beautiful alternative to glass, crystal, or disposables
- Use durable trays for catering, parties, weddings, conventions, cruise lines, or poolside service
- Molded-in pattern gives the appearance of fine etched crystal
- Economical, break-resistant SAN resists food acids and oils
- Lowers replacement costs
- Safe in temperatures from 0° to 180°F
- Dishwasher safe



Tray Stands

- Cross supports provide superior rigidity and strength
- Durable and easy to clean
- Available in 3 forms: Steel, Wood & Plastic
- Capped legs on steel tray stands prevent slipping and marring of floors
- Extra tall steel tray stand (C3625T) reduces need for bending and stooping; additional height makes transferring heavy loads easier
- Plastic stands have sanitary, non-porous & non-corrosive finish that is easy to clean with a damp cloth
- Works great with Griptite and GripLite trays



Prod No	Description	Color	Pack
Festival Trays			
6413	13" Round Tray	07	12 ea
6416	16" Round Tray	07	12 ea
6417	12.5" x 7" Rectangular Tray	07	12 ea
6450	15" x 10.75" Rectangular Tray	07	12 ea
6426	22" x 16" Handled Tray	07	6 ea
6439	13" x 19.5" Handled Tray	07	6 ea
Tray Stands			
C3625	31.5" Steel Stand	03	6 ea
C3625T	36" Tall Steel Stand	38	6 ea
C3620W	30" Wood Stand	11	6 ea
C3630W	30.5" Plastic Stand	11	6 ea



CARLISLE
FOODSERVICE PRODUCTS

RUGGED BEAUTIFUL PORTABLE CONVENIENT **CATERING EQUIPMENT**

Carlisle's catering equipment line is the professional's choice for your insulated transport needs. Only Carlisle Cateraide's can offer attractive contemporary styling, longer hold times, and unique battle tested features that provide you superior value.





Choose The CATERAIDE™ To Best Fit Your Needs.

All CATERAIDES are NSF Listed and made of rugged, stain, and scratch-resistant polyethylene.

Good

PC Series pan carriers have exclusive, automatic, self-venting system. LD and XT beverage servers have easy-grip, formed handles for easy transporting.



LD, XT & PC Series



Better

Carlisle's better line of CATERAIDES offers an ergonomic design for easy loading, handling, stacking and storing. The patented* Slide 'N Seal's lids and doors glide shut and stay closed without latches or gaskets. Slide 'N Seal's metal-free line makes it the perfect fit for correctional facilities.

*Slide 'N Seal Pan Carrier Patent No. 7,134,552



Slide 'N Seal





Best



Carlisle brings you the best in temperature retention products with the redesigned Cateraide IT insulated transport line. The Cateraide's sturdy construction offers a long-lasting product and the thick foam insulation holds temperatures in the safe zone for over 6 hours. Our special coating gives the IT a beautiful, glossy sheen. The new, sleek design gives an updated, contemporary look to any table setting.

IT Series





CATERAIDE™ IT

Introducing the **newly designed** CATERAIDE IT insulated transport line of products. IT is the only choice for foodservice professionals demanding they have it all. For the first time, rugged durability and industry leading safe food holding times are combined with **attractive, contemporary styling**. CATERAIDE IT sets a **new standard for value**.

Insulated Beverage Dispenser

- Heavy foam insulation holds temperatures in the safe zone for over 6 hours
- Field adjustable latches ensure a secure seal for the life of the carrier
- "Spring Action" faucet for no drip service
- Button-hole latch design offers convenient one hand operation and keeps the doors and lids closed tightly for better temperature retention
- Sure-grip handles promote a safe, stable, two-person lift for easy loading and unloading
- Custom logo printing available



IT500



YOUR LOGO HERE



Exclusive molded in process puts your logo in front of the customer. Contact your local sales rep for more details.



Prod No	Description	Color	Pack
CATERAIDE IT			
IT250 Δ	2.5 gal Beverage Dispenser	03, 43, 62	1 ea
IT500 Δ	5 gal Beverage Dispenser	03, 43, 62	1 ea
IT1000 Δ	10 gal Beverage Dispenser	03, 43, 62	1 ea

NSF Listed products are designated with a Δ and may be prefixed with an N
Note: IT1000 can be shipped UPS/FedEx ground at oversize cost

End & Top Loader

- Heavy foam insulation holds temperatures in the safe zone for over 6 hours
- Secure stacking for easy transport and storage
- Sure-grip handles promote a safe, stable, two-person lift for easy loading and unloading
- Exclusive, low-profile, double hinge opens 270° for easy loading and unloading; lies flat to save space and makes it less likely to break
- Field adjustable latches ensure a secure seal for the life of the carrier
- Door hinge can be removed for easy, thorough cleaning
- Built-in seal eliminates gaskets on end & top loaders
- Holds six 2-1/2" deep food pans
- Use with CaterCooler to help keep foods at ServeSafe® temps longer (shown on page 174)
- Custom logo printing available; contact customer service at 1-800-654-8210 for additional information

ServeSafe® is a registered trademark of the National Restaurant Association



Flat top design can be used as a prep surface when space is limited



Button-hole latch design offers convenient one hand operation



Exclusive double hinge opens 270°



4 rotating wheels give this dolly unmatched maneuverability



Prod No	Description	Color	Pack
Cateraide IT			
IT400 Δ	End Loader (six pan capacity)	03, 43, 62	1 ea
IT140 Δ	4" Top Loader (holds one full size pan up to 4" deep)	03, 43, 62	1 ea
IT160 Δ	6" Top Loader (holds one full size pan up to 6" deep)	03, 43, 62	1 ea
IT180 Δ	8" Top Loader (holds one full size pan up to 8" deep)	03, 43, 62	1 ea
IT410 Δ	End Loader Dolly with Casters	03	1 ea

NSF Listed products are designated with a Δ and may be prefixed with an N
 Note: IT180, IT400 can be shipped UPS/FedEx ground at oversize cost



CATERAIDE™ SLIDE 'N SEAL

Only the Carlisle Slide 'N Seal offers **latch free construction** with no metal parts. Perfect for outdoor use in recreation and leisure markets, schools, and correctional facilities.

Insulated Beverage Dispenser

- Revolutionary Slide 'N Seal design is combined with Carlisle's thick insulation to hold temperatures longer
- Patented* Slide 'N Seal design glides shut and closes tightly without latches
- The integrated seal keeps beverages hot or cold longer
- Sleek contemporary appearance; ergonomically designed for easy loading, handling, stacking, and storing
- Tough, scratch-resistant polyethylene construction is easy to clean and maintain
- No metal parts – ideal for correctional facilities
- "Spring action" faucet for dripless service
- NSF Listed

*Slide 'N Seal Patents Beverage Dispensers: Patent No. 7,328,816



Easy twist on/off lid for leak-proof transport



Molded-in handles for easy transport



Lock can be placed through molded-in tag hole for a secure, tamper-proof closure

Find replacement parts at www.carlislefsp.com/replacement-parts



Prod No	Description	Color	Pack
Slide 'N Seal Beverage Dispensers			
XB5 Δ	5 gal Slide 'N Seal Beverage Dispenser	01, 03, 08	1 ea

NSF Listed products are designated with a Δ and may be prefixed with an N



Top & End Loaders

- Revolutionary Slide 'N Seal design is combined with Carlisle's thick insulation to hold temperatures longer
- Patented* Slide 'N Seal lids and doors glide shut and stay closed without latches or gaskets
- The integrated seal keeps food hot or cold longer
- Self-venting lids and doors keep foods fresher, crisper and more appetizing
- Exclusive lid design has a molded-in tethered lock pin to seal carrier for safety
- End Loader has molded-in tag slot to seal and tag carrier for safety and food identification
- Sleek contemporary appearance; ergonomically designed for easy loading, handling, stacking and storing
- Tough, scratch-resistant polyethylene construction is easy to clean and maintain
- No metal parts – ideal for correctional facilities
- Use with CaterCooler to help keep foods at ServeSafe® temps longer (shown on page 174)
- NSF Listed

*Slide 'N Seal Patents

Pan Carriers: Patent No. 7,134,552



Sliding doors easily open and close for quick access and transport



Find replacement parts at
www.carlislefsp.com/replacement-parts

Prod No	Description	Color	Pack
Slide 'N Seal Top Loaders			
XT1400 Δ	4" Slide 'N Seal Top Loader	03	1 ea
XT1600 Δ	6" Slide 'N Seal Top Loader	01, 03, 08	1 ea
XT1800 Δ	8" Slide 'N Seal Top Loader	01, 03	1 ea
Slide 'N Seal End Loaders			
XT3000R Δ	Slide 'N Seal End Loader	01, 03	1 ea

NSF Listed products are designated with a Δ and may be prefixed with an N
 NOTE: XT1800, XT3000R can be shipped UPS/FedEx Ground at oversize cost

CATERAIDE™ XT & LD

XT Series Insulated Beverage Dispenser - *The Value Leader*

- Made of rugged, stain- and scratch-resistant polyethylene
- Filled with extra thick foam insulation for maximum temperature retention
- Stacks with itself and with other major competitors
- Smooth interior walls and rounded corners leave no food traps and provides quick clean-up
- Convex lid design prevents leaks during use as pressure increases
- Modern XT lid design with convenient pop-up vent
- Improved O-ring seal eliminates leaks during transport
- Easy-grip, formed handles for transporting
- Sure-Latch™ wide design has three times the latch area of other beverage servers for a secure seal
- Latches are mounted into steel reinforcement plates for long life
- “Spring action” faucet for dripless service
- NSF Listed



Find replacement parts at www.carlislefsp.com/replacement-parts



Prod No	Description	Color	Pack
Cateraide XT Beverage Servers			
XT2500 Δ	2.5 gal Beverage Server	01, 03, 08, 59	1 ea
XT5000 Δ	5 gal Beverage Server	01, 03, 08, 59	1 ea
XT10000 Δ	10 gal Beverage Server	01, 03, 08, 59	1 ea

NSF Listed products are designated with a Δ and may be prefixed with an N

NOTE: XT10000 can be shipped UPS/FedEx Ground at oversize cost

LD Series Insulated Beverage Dispensers

- Made of rugged, stain- and scratch-resistant polyethylene
- Filled with extra thick foam insulation for maximum temperature retention
- Stacks with itself and with other major competitors
- Smooth interior walls and rounded corners leave no food traps and provides quick clean-up
- Convex lid design prevents leaks during use as pressure increases
- Reinforced, tight-fitting lids with O-ring seals prevent leaks and provide increased heat retention
- Easy-grip, formed handles for transporting
- “Spring action” faucet for dripless service
- Nylex II™ latches have no sharp edges, won't rust, bend or dent like metal, and are mounted into steel reinforcement plates for long life
- NSF Listed



Find replacement parts at
www.carlislefsp.com/replacement-parts



Prod No	Description	Color	Pack
Cateraide LD Beverage Servers			
LD250N Δ	2.5 gal Beverage Server	01, 03	1 ea
LD500N Δ	5 gal Beverage Server	01, 03, 08, 59	1 ea
LD1000N Δ	10 gal Beverage Server	01, 03, 08, 59	1 ea

NSF Listed products are designated with a Δ and may be prefixed with an N
 NOTE: LD1000N can be shipped UPS/FedEx Ground at oversize cost



CATERAIDE™

Insulated Soup & Chili Servers - *Ideal for Food Festivals & Outdoor Venues*

- Same high-quality features and construction as our standard Cateraides
- Perfect for transporting and serving soup and chili
- Stacks with 2.5 gallon & 5 gallon beverage servers
- There are no faucets
- NSF Listed



CaterCooler™

- Freeze CaterCooler overnight or for eight hours and it will keep food at or below the ServSafe® guidelines of 40°F for up to eight hours without ice*
- Designed to slide into a Cateraide End Loader, Double End Loader, or place on top of food pans in a Top Loader
- Durable polyethylene shell

ServSafe® is a registered trademark of the National Restaurant Association

*Temperature retention is based on CaterCooler being pre-frozen for a minimum of eight hours, then placed directly into Cateraide pan carrier. Pan Carrier unit is then filled with pre-chilled food pans. Testing was conducted under ambient room temperatures of 76°F.



PC660

CaterCooler shown with PC300N End Loader



Prod No	Description	Color	Pack
Cateraide Insulated Soup & Chili Servers			
LD350N Δ	3.5 gal Soup & Chili Server	01, 03	1 ea
LD500NSS Δ	5 gal Soup & Chili Server	01, 03	1 ea
CaterCooler			
PC660	CaterCooler	14	1 ea

NSF Listed products are designated with a Δ and may be prefixed with an N

NOTE: LD500NSS can be shipped UPS/FedEx Ground at oversize cost

Pan Carriers

- Cateraide construction made of rugged, stain- and scratch-resistant polyethylene
- Filled with extra thick foam insulation for maximum temperature retention
- Exclusive automatic self-venting system eliminates unsanitary vent openings and easily lost vent caps
- Heat resistant to 200°F
- Find replacement parts at www.carlislefp.com/replacement-parts
- NSF Listed



Insulated Sheet Pan & Tray Carrier

- Individual tracks accommodate seven 18" x 26" trays
- Use with sheet pans shown on page 189
- NSF Listed



Insulated Top Loaders

- Accommodates all third, half, and full size food pans
- PC188N top loader holds up to 8" deep food pan

Insulated End Loader

- Individual track for each food pan
- PC300N end loader holds five 2.5" deep pans
- PC600N has twice the capacity of the PC300N
- PC600N's separate compartments enable you to put hot food in one; cold in the other
- Use with CaterCooler to help keep foods at ServeSafe® temps longer (shown on page 174)
- NSF Listed

Use with DuraPan™ or StorPlus™ Food Pans shown on pages 216-223



Prod No	Description	Color	Pack
Cateraide Insulated Top Loaders			
PC140N Δ	12 qt, 4" Single Pan Carrier	01, 03	1 ea
PC160N Δ	18 qt, 6" Single Pan Carrier	01, 03	1 ea
PC180N Δ	24 qt, 8" Combination Pan Carrier	01, 03	1 ea
Cateraide Insulated Sheet Pan & Tray Carrier			
TC1826N Δ	Sheet Pan, Tray Carrier	01, 03	1 ea
Cateraide Insulated End Loaders			
PC300N Δ	End Loader	01, 03, 08, 59, 95	1 ea
PC600N Δ	Double End Loader	01, 03, 08, 59	1 ea

NSF Listed products are designated with a Δ and may be prefixed with an N



CATERAIDE™

Dollies - *Industry Leader*

Polyethylene Dollies

- 4" heavy-duty, quiet, and non-marking swivel casters
- Rolls easily on carpeted floors
- DL300R holds up to two Cateraide End Loaders (PC300N) or any Cateraide Top Loader
- XDL3000 holds up to two Slide 'N Seal End Loaders (XT3000R) when stacked
- NSF Listed



DL300R

XDL3000H

Aluminum Dollies

- Made of sturdy, light-weight, no-rust aluminum
- Plastic coated corner bumpers protect against marring furnishings
- 4" heavy-duty, quiet, and non-marking swivel casters
- Rolls easily on carpeted floors
- DL300 holds up to two stacked Cateraide End Loaders
- DL1826 holds up to three stacked Sheet Pan Carriers



DL1826

DL300

Universal

- Moves up to 6 fully loaded top loaders with ease, even on carpeted floors
- 600 lb load capacity
- Eyelets for cargo straps
- 5" non-marking casters (2 rigid, 2 swivel—one with brake)
- NSF Listed



UD1726



Prod No	Description	Color	Pack
Polyethylene Cateraide Dollies			
XDL3000H Δ	22.38" x 28.75" Dolly with Handle	03	1 ea
DL300R Δ	20.38" x 26.75" Dolly	03	1 ea
Aluminum Cateraide Dollies			
DL300	23.25" x 16.88" Dolly	23	1 ea
DL1826	28.63" x 22" Dolly	23	1 ea
Cateraide Universal Dolly			
UD1726 Δ	Universal Dolly	03	1 ea

NSF Listed products are designated with a Δ and may be prefixed with an N
 NOTE: Cateraide Universal Dolly is not UPS/FedEx Ground shippable

Insulated Ice Caddies

- Cateraide construction made of rugged, stain- and scratch-resistant polyethylene
- Filled with extra thick foam insulation for maximum temperature retention
- Rounded inside corners and removable lid for thorough cleaning
- Stainless steel, reinforced hinges prevent rusting
- Easy rolling, heavy-duty 5" casters
- Find replacement parts at www.carlislefp.com/replacement-parts

200 Lb Caddy

- Lid opens and lays flat against side of unit to conserve space
- Front faucet for fast drainage and easy cleanup; inside has sloped base for complete drainage
- Includes convenient shelf; allows water to drain away from ice
- Dual handles for easy maneuverability
- 10" non-marking back wheels roll easily over rough surfaces



IC2220

125 Lb Caddies

- Nylex™ latches eliminate sharp edges; won't rust, bend, or dent
- Ice Caddies IC2250 and IC2254 are only 28.75" high for smaller, more compact space requirements
- IC2250T Ice Caddy is 36.5" high to reduce back bending motion
- IC2250T Ice Caddy has 8" non-marking back wheels for easy maneuvering over rough surfaces
- NSF Listed



IC2250T

IC2254



Prod No	Description	Color	Pack
Cateraide Ice Caddies			
IC2220	200 lb Ice Caddy with Ice Caddy Shelf; 10" Wheels, 2 Swivel Casters (one with brake)	01, 03, 08, 59	1 ea
IC2250 Δ	125 lb Ice Caddy; 2 Rigid Casters, 2 Swivel Casters (one with brake)	01, 03	1 ea
IC2254 Δ	125 lb Ice Caddy; 4 Swivel Casters (one with brake)	01, 03	1 ea
IC2250T Δ	125 lb Tall Ice Caddy; 8" Wheels, 2 Swivel Casters (one with brake)	03	1 ea

NSF Listed products are designated with a Δ and may be prefixed with an N

Note: Ice Caddies cannot ship UPS/FedEx Ground



Mrs. Lari

FRANCIS LITTLE
TECHNOLOGY GROUP

CARLISLE
FOODSERVICE PRODUCTS

QUALITY
DURABLE
STRONG
**PROFESSIONAL
COOKWARE**

Carlisle cookware and bakeware is designed to support professional chefs, helping them to succeed in their constant pursuit to delight their guests with great food. Our wide selection of top-quality products delivers reliable, long-lasting value to your operation.





FRY PANS

Excalibur Fry Pans feature a **reinforced non-stick coating** to protect your fry pans from daily wear and tear.

Excalibur® Fry Pans

- Stainless steel reinforced non-stick coating is micro-bonded to the substrate of the pan creating a multi-layer surface that easily releases food and resists scratching better than traditional non-stick surfaces
- Excalibur cooks food evenly without the need for added fat or oil
- Hard 3004 aluminum body stands up to the toughest foodservice environment
- Removable Dura-Kool™ Sleeves
- Use with High Heat Turner shown on page 211 of the foodservice catalog
- NSF Listed



Excalibur® surface resists scratching from metal utensils better than any other coating

Teflon Select® Fry Pan

- Teflon Select, DuPont's professional non-stick surface is extremely durable and extra smooth
- Improved coating features 75% greater longevity and 75% more resistance to abrasion than regular Teflon
- Hard 3004 aluminum body stands up to the toughest foodservice environment
- Use with High Heat Turner shown on page 211 of the foodservice catalog
- NSF Listed



Prod No	Description	Cover	Pack
Excalibur Fry Pans			
60907XRS Δ	7" Excalibur Fry Pan	60907C	12 ea
60908XRS Δ	8" Excalibur Fry Pan	60908C	12 ea
60910XRS Δ	10" Excalibur Fry Pan	60910C	6 ea
60912XRS Δ	12" Excalibur Fry Pan	60912C	6 ea
60914XRS Δ	14" Excalibur Fry Pan	60914C	3 ea
Teflon Select Fry Pans			
60907SERS Δ	7" Teflon Select Fry Pan	60907C	12 ea
60908SERS Δ	8" Teflon Select Fry Pan	60908C	12 ea
60910SERS Δ	10" Teflon Select Fry Pan	60910C	6 ea
60912SERS Δ	12" Teflon Select Fry Pan	60912C	6 ea
60914SERS Δ	14" Teflon Select Fry Pan	60914C	3 ea

NSF Listed products are designated with a **Δ** and may be prefixed with an N
 Teflon® is a registered trademark of E.I. DuPont® DeNemours & Co., Inc.
 Excalibur® is a registered trademark of Whitford B. U. Corp.



Covers sold separately on page 185
Recommended covers listed in the product charts

Traditional Aluminum Fry Pans

- Hard 3004 aluminum body stands up to the toughest foodservice environment
- Gently sloped sides are ideal for turning, flipping, and removing foods
- Aluminum material provides excellent heat transfer
- NSF Listed



SSAL™ Fry Pans

- Finest 18-8 stainless interior is permanently bonded to hard aluminum body to create the ultimate fry pan for any foodservice environment
- Aluminum body ensures maximum heat transfer throughout the pan and eliminates hot spots and scorching
- Easy care stainless interior is incredibly durable and will not react with food or discolor sauces
- Special rivet design securely attaches handle to pan; bond will not loosen like traditional rivets
- NSF Listed



Prod No	Description	Cover	Pack
Traditional Aluminum Fry Pans			
60907RS Δ	7" Aluminum Fry Pan	60907C	12 ea
60908RS Δ	8" Aluminum Fry Pan	60908C	12 ea
60910RS Δ	10" Aluminum Fry Pan	60910C	6 ea
60912RS Δ	12" Aluminum Fry Pan	60912C	6 ea
60914RS Δ	14" Aluminum Fry Pan	60914C	3 ea
SSAL Fry Pans			
60708RS Δ	8" SSAL Fry Pan	60908C	12 ea
60710RS Δ	10" SSAL Fry Pan	60910C	6 ea
60712RS Δ	12" SSAL Fry Pan	60912C	6 ea

NSF Listed products are designated with a Δ and may be prefixed with an N



COOKWARE

Standard Weight Aluminum Cookware

Standard Weight Aluminum Cookware is made from 3003 alloy that allows cookware to heat rapidly and retain even heat. A double thick top edge and base offer superior strength and shape retention. All Standard Weight Aluminum Cookware is NSF Listed.



Stock Pots

- Perfect for preparing soups, pastas, or long-simmering stocks and sauces
- Can also be used with our stainless steel baskets for steaming, boiling, or deep frying

Braziers

- Brazier's wide surface is perfect for browning meats and simmering stews
- Heavy plated loop handles for easy transport
- Optional covers maintain moist heat for slow cooking



Covers sold separately on page 185
Recommended covers listed in the product charts

Prod No	Description	Cover	Pack
Standard Weight Stock Pots			
61210 Δ	10 qt Standard Weight Stock Pot	61210C	1 ea
61212 Δ	12 qt Standard Weight Stock Pot	61210C	1 ea
61216 Δ	16 qt Standard Weight Stock Pot	61216C	1 ea
61220 Δ	20 qt Standard Weight Stock Pot	61220C	1 ea
61224 Δ	24 qt Standard Weight Stock Pot	61224C	1 ea
61232 Δ	32 qt Standard Weight Stock Pot	61232C	1 ea
61240 Δ	40 qt Standard Weight Stock Pot	61240C	1 ea
61260 Δ	60 qt Standard Weight Stock Pot	61260C	1 ea
61280 Δ	80 qt Standard Weight Stock Pot	61280C	1 ea
61200 Δ	100 qt Standard Weight Stock Pot	61200C	1 ea
Standard Weight Braziers			
61115 Δ	15 qt Standard Weight Brazier	61232C	1 ea
61120 Δ	20 qt Standard Weight Brazier	61120C	1 ea
61125 Δ	25 qt Standard Weight Brazier	61125C	1 ea
61130 Δ	30 qt Standard Weight Brazier	61130C	1 ea

NSF Listed products are designated with a Δ and may be prefixed with an N



Sauté Pans

- Low sided sauté pans are designed for high heat browning or quick cooking
- Come with removable Dura-Kool sleeves
- Heavy-weight aluminum



Straight Sided Aluminum Sauce Pans

- Rounded corners for easy stirring, helps prevent thick sauces from burning
- Heavy-duty, straight-sided pan's thick base provides quick and even heating for thorough cooking



Tapered Aluminum Sauce Pans

- Tapered shape reduces contact with direct heat source and encourages cooking by diffusing heat from the side walls
- Sides are gently sloped and corners are rounded for easy stirring
- Tapered design nests for convenient storage
- Extra wide lip adds durability and offers more precise pouring
- 8.5 & 10 qt saucepan have side handle to aid lifting



Sectional Pasta Cookers

- Ideal for pasta, vegetables, and seafood
- Save time, energy, and space by cooking multiple portions in one pot
- Stainless steel inserts with .13" holes feature cool-touch handles and can be hooked on the side of the pot for easy draining
- Complete unit includes 20 qt pot and 4 quarter size inserts

Prod No	Description	Cover	Pack
Standard Weight Sauté Pans			
61905 Δ	5 qt Sauté Pan	61905C	6 ea
61907 Δ	7 qt Sauté Pan	61907C	6 ea
Standard Weight Straight Sided Sauce Pans			
61302 Δ	2.5 qt Standard Weight Sauce Pan	61302C	6 ea
61305 Δ	5 qt Standard Weight Sauce Pan	61305C	6 ea
61308 Δ	8.5 qt Standard Weight Sauce Pan	61308C	6 ea
Standard Weight Tapered Sauce Pans			
61702 Δ	2.5 qt Tapered Sauce Pan	61702C	6 ea
61704 Δ	4.5 qt Tapered Sauce Pan	61704C	6 ea
61707 Δ	6 qt Tapered Sauce Pan	61707C	6 ea
61708 Δ	8.5 qt Tapered Sauce Pan	61708C	6 ea
61710 Δ	10 qt Tapered Sauce Pan	61710C	6 ea
Sectional Pasta Cooker			
60100PC	Quarter Size Sectional Pasta Cooker includes 20 qt pot with 4 inserts	—	1 ea
60102	20 qt Pot for Pasta Cooker Combination	—	2 ea
60101	Quarter Size Perforated Insert	—	4 ea

NSF Listed products are designated with a Δ and may be prefixed with an N



COOKWARE

Mesh Baskets

Nickel Plated

- Perfect for cooking or reheating single servings of pasta
- Baskets can also be used for small batch frying or breading
- Stainless baskets feature cool-touch handles and heavy-duty chrome steel hook for draining basket

Chrome Plated



Nickel Plated

Chrome Plated

- Chrome plated carbon steel basket is designed for small batch deep frying
- Chrome plated carbon basket not intended for use in water



Colanders

- Seamless satin finish aluminum construction with rolled top edge for extra strength
- Sturdy handles are securely riveted on sides



Burger Cover

- Accelerates cooking on grill tops
- Aluminum cover provides quick and even heating for thorough cooking
- Helps retain flavor and moisture
- Heat resistant knob is cool to the touch

Double Boiler

- Heavy-duty construction and extra thick base for superior thermal conductivity; prevents scorching of delicate sauces, chocolate, and more
- Traditional weight, satin finish cookware
- Durable rolled edge with sanitary open bead
- Double boiler includes stock pot, insert and cover; inserts are also available separately
- NSF Listed



Prod No	Description	Pack
Nickel Plated Mesh Baskets		
601028	8.75" Fryer Basket	12 ea
601029	9.75" Fryer Basket	12 ea
601031	11.5" Fryer Basket	12 ea
Colander		
60280	16 qt Standard Weight Colander	6 ea
Chrome Plated Carbon Steel Mesh Baskets		
601000	8.75" Fryer Basket	12 ea
601001	9.75" Fryer Basket	12 ea
601002	11.5" Fryer Basket	12 ea
601003	13.5" Fryer Basket	12 ea
Burger Cover		
60103	6" Burger Cover	12 ea
Double Boilers		
60921 Δ	12 qt Double Boiler with 12 qt Insert	1 ea
60934 Δ	20 qt Double Boiler with 16 qt Insert	1 ea

NSF Listed products are designated with a Δ and may be prefixed with an N



Heavy-Duty Covers

- Carlisle's unique reinforced design resists dents and holds its shape better than old-fashioned lids
- Extra heavy-duty covers are fabricated from hard 3004 aluminum to stand up to the toughest foodservice environment
- Open looped handles are securely riveted
- NSF Listed



Domed Fry Pan Covers

- Domed covers fit snugly on the pans creating a self-basting effect by allowing moisture to condense and return to the pan
- Strong welds on handle ensure long life
- NSF Listed



Prod No	Description	Pack
Heavy-Duty Covers		
61120C Δ	Cover for 61120	6 ea
61125C Δ	Cover for 61225	6 ea
61130C Δ	Cover for 61130	6 ea
61200C Δ	Cover for 61200	6 ea
61210C Δ	Cover for 61210 & 61212	6 ea
61216C Δ	Cover for 61216	6 ea
61220C Δ	Cover for 61220	6 ea
61224C Δ	Cover for 61224	6 ea
61232C Δ	Cover for 61232 & 61115	6 ea
61240C Δ	Cover for 61240	6 ea
61260C Δ	Cover for 61260	6 ea
61280C Δ	Cover for 61280	6 ea
61302C Δ	Cover for 61302	6 ea
61305C Δ	Cover for 61305	6 ea
61308C Δ	Cover for 61308	6 ea
61702C Δ	Cover for 61702	6 ea
61704C Δ	Cover for 61704	6 ea
61707C Δ	Cover for 61707	6 ea
61708C Δ	Cover for 61708	6 ea
61710C Δ	Cover for 61710	6 ea
61905C Δ	Cover for 61905	6 ea
61907C Δ	Cover for 61907	6 ea
Domed Fry Pan Covers		
60907C Δ	7" Dome Fry Pan Cover	6 ea
60908C Δ	8" Dome Fry Pan Cover	6 ea
60910C Δ	10" Dome Fry Pan Cover	6 ea
60912C Δ	12" Dome Fry Pan Cover	6 ea
60914C Δ	14" Dome Fry Pan Cover	3 ea

NSF Listed products are designated with a Δ and may be prefixed with an N



BAKEWARE

Roast & Bake Pans

- Extra large, heavy-duty sizes capable of holding multiple roasts, hams, or turkeys
- Reinforced rolled edge for added strength
- 60306, 601923 have securely riveted drop handles for easier and safer lifting of heavy loads
- NSF Listed



601922



60306



601923

Commercial Weight Double Roasters

- Commercial weight aluminum roasters are equipped with 2 steel reinforced bands for extra heavy usage
- Pans feature seamless drawn sanitary open bead
- Covers and bases can also be used individually as open roasters
- Full size pans fit standard baker's racks
- Drop handles are securely riveted
- 60345's fabricated lugs hold top securely in place
- NSF Listed



60346



60344



60345

Prod No	Description	Pack
Roast & Bake Pans		
60306 Δ	21 ga, 8 qt Bake Pan with Drop Handles; 17" x 11" x 2.5"	6 ea
601922 Δ	17 ga, 13.5 qt Bake Pan; 26" x 18" x 2.25"	6 ea
601923 Δ	17 ga, 19 qt Bake Pan with Drop Handles; 26" x 18" x 3.5"	4 ea
Commercial Weight Double Roasters		
60346 Δ	Double Roaster; 24" x 18" x 9" (includes 60344 & 60345)	1 ea
60344 Δ	16 ga, 26 qt Roast Pan (use as cover); 24" x 18" x 4.5"	2 ea
60345 Δ	16 ga, 26 qt Roast Pan (use as base); 24" x 18" x 4.5"	2 ea

NSF Listed products are designated with a Δ and may be prefixed with an N



Aluminized Steel Pans



601837
601834
601840
601829



606903
606902

Baking Pans

- Aluminized steel pans are the ultimate choice for baking breads, cupcakes, muffins, and cakes
- The special finish provides greater heat transfer for lower baking temperatures, shorter baking time, and better looking, more uniform baked goods
- Corrosion-resistant material withstands temperatures in excess of 700°F
- Individual seamless cups are locked into heavy frames

Bread Pans & Pullman Pans

- Aluminized steel pans are the ultimate choice for baking breads and cakes



604144

602164

604174

Prod No	Description	Pack
Aluminized Steel Baking Pans		
601829	24 Cup/1.75 oz Mini-Muffin/Cupcake Pan	6 ea
601830	12 Cup/3.5 oz Heavy-Duty Cupcake Pan	12 ea
601840	24 Cup/3.5 oz Heavy-Duty Cupcake Pan	6 ea
601834	12 Cup/4 oz Large Cup Cupcake Pan	6 ea
601837	12 Cup/6 oz Extra Large Cup Cupcake Pan	6 ea
606902	6 Loaf Mini Loaf Pan (Loaf Size: 4" x 2.5" x 2.25")	6 ea
606903	12 Loaf Mini Loaf Pan (Loaf Size: 4" x 2.5" x 1.38")	6 ea
Aluminized Steel Bread Pans		
604144	1 lb Loaf Bread Pan, 9.5" x 5" x 2.77"	12 ea
604174	1.75 lb Loaf Bread Pan, 12.8" x 5" x 2.8"	12 ea
Aluminized Steel Pullman Pans		
602164	32 oz Pullman Pan with Cover, 17.5" x 4.65" x 4.1"	12 ea
602164C	Pullman Pan Cover (only)	12 ea
602164P	Pullman Pan (only), 17.5" x 4.65" x 4.1"	12 ea



BAKEWARE

Heavy-Duty Muffin Pan

- Heavy-duty muffin pan has seamless cups locked into heavy aluminum frame
- Holds up in busy foodservice environments



602424

Pie Pans

- Heavy 18 gauge, natural finish aluminum spreads heat evenly for better baking



60322
60324

Prod No	Description	Pack
Heavy-Duty Muffin Pan		
602424	24 Cup/3 oz Aluminum Muffin Pan	12 ea
Pie Pans		
60322	9" Pie Pan – 1.25" Deep	24 ea
60324	10" Pie Pan – 1.31" Deep	24 ea



Bun Pans & Sheet Pans

- Sturdy bun pans for baking, transporting, and displaying cookies, bread, and pastries
- Aluminum surface allows even browning of foods
- Manufactured from extra hard, tempered aluminum alloy with galvanized steel wire reinforced bead
- Tapered shape stacks for storage
- Use with Icing Grates listed below



Icing Grates

- Use grates for thawing foods or cooling and icing cakes, cookies, and desserts
- 601306 welded icing grate fits full size bun pans and is made of nickel plated steel
- 601642, 601647 mesh icing grates are made of heavy, steel mesh wire



Prod No	Description	Pack
Bun Pans & Sheet Pans		
601825	18 ga, Full Size Sheet Pan; 25.75" x 17.81" x 1.13"	12 ea
601826	16 ga, Heavy-Duty Full Size Sheet Pan; 25.75" x 17.81" x 1.13"	12 ea
601824	18 ga, Half Size Bun Pan; 17.81" x 12.88" x 1"	12 ea
601828	18 ga, Perforated Full Size Sheet Pan; 25.75" x 17.81" x 1.13"	12 ea
Icing Grates		
601306	Icing Grate, Fits 601825, 601826, 601828 Bun Pan	12 ea
601642	Mesh Icing Grate, Fits 601824 Bun Pan	12 ea
601647	Mesh Icing Grate, Fits 601825, 601826, 601828 Bun Pan	12 ea



CARLISLE
FOODSERVICE PRODUCTS

QUALITY
EFFICIENT
DURABLE
INNOVATIVE
**KITCHEN
ACCESSORIES**

Designed and used by chefs, Carlisle kitchen accessories are designed to improve food safety and quality, save labor, and reduce waste. You need to operate your kitchen efficiently and effectively every day and you can count on Carlisle to help make work easier.





ALLERGEN CONTROL PRODUCTS

In a kitchen, the **most dangerous allergen** is the one that isn't identified. Use Carlisle **Allergen Control Products** and employees will know how to handle allergen sensitive orders and customers will know they're in good hands

The Big 8

is a group of the eight major allergenic foods. These foods account for approximately 90% of all food allergies in the United States

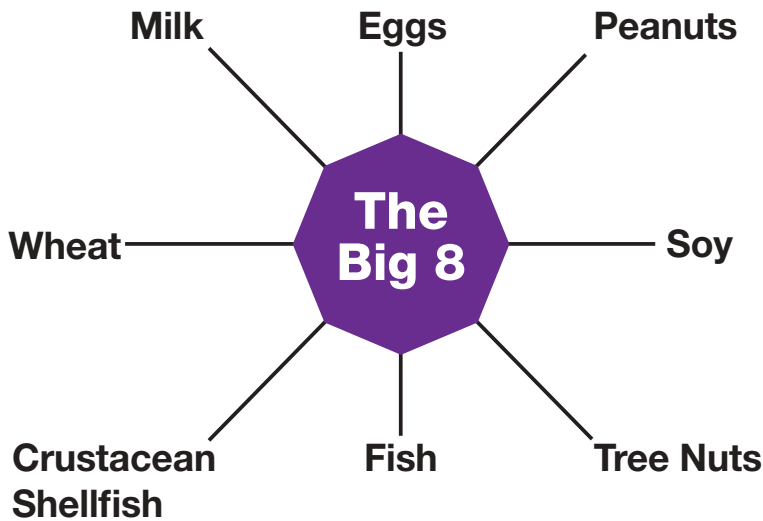

Symptoms of an Allergic Reaction

Nausea

Wheezing /
Shortness of
Breath

Hives /
Itchy Rashes

Swelling of
Face, Eyes,
Hands or Feet

Vomiting /
Diarrhea

Abdominal Pain



Capacity indicators allow measuring, prepping and portioning in a single container for added versatility, efficiency and inventory control



StorPlus Square Container
Pages 226-227

Bold purple markings make these measuring cups easy to read



Commercial Measuring Cup
Page 202

Carlisle offers purple Measure Misers in a variety of sizes with the capacity molded into the handle for portion control



Measure Misers
Page 205

Purple Color-Coded Cutting Boards fit into HACCP guidelines for food segregation



Spectrum Cutting Board
Pages 192-193

Purple tote boxes are perfect for ensuring that cross-contamination doesn't happen during the cleaning process



Comfort Curve Tote Boxes
Page 248

Purple Bronco Waste Containers are NSF Listed for food contact and cleanability—perfect for food storage



Bronco Waste Containers
Pages 321-322



CUTTING BOARDS & ACCESSORIES

Sparta® Spectrum® Cutting Boards

- Sparta Spectrum Color-Coded Products are a key group of CCP (Critical Control Point™) Products designed to promote safe food handling and help prevent hazardous cross-contamination
- Help meet HACCP guidelines by promoting segregated food prep for different foods
- HDPE (High Density Polyethylene) construction offers a durable cutting surface, and a high stability, warp-resistant cutting board
- Hygienic surface texture on boards prevents deep cuts and is easy to clean
- NSF Listed; dishwasher safe



	Allergen Control
	Dairy or Dry Food
	Produce
	Prepared Food
	Meat
	Fish
	Poultry

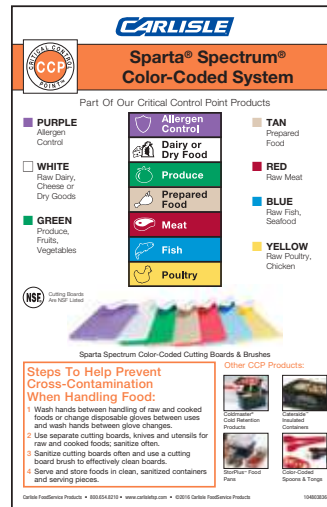

10889WC Laminated Spectrum Wall Chart for quick color usage reference



NSF mark is permanently stamped on board to meet health department requirements

Spectrum Wall Chart

- Quick reference laminated chart in both English and Spanish
- Included with all assortment cutting board packs
- Sold separately

Produce



Spectrum color-coded cutting boards promote safe food handling

Dairy



Color-coding to food type helps prevent hazardous cross-contamination

Fish



Use Spectrum brushes for a complete HACCP system

Accessories

- Carlisle's Cutting Board Accessories support a complete HACCP System

Board & Brush Racks

- All products are dishwasher safe and easy to clean

Sparta Spectrum Cutting Board Brushes

- Ergonomically shaped handles and crimped polyester bristles are rugged and will not absorb food oils or moisture

Griptite Mat

- Textured mat holds boards in place
- NSF Listed; dishwasher safe



Cutting Board Scraper/Refinisher Tool

- Removes cuts from cutting boards
- Saves money on fewer replacement cutting boards
- Dishwasher safe

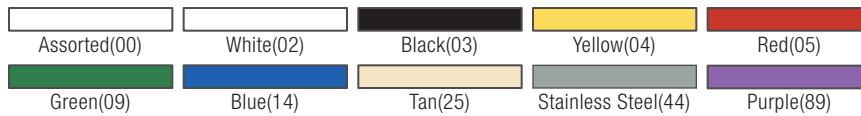

Prod No	Description	Color	Pack
Cutting Boards			
10901 Δ	6" x 9" x .5" White Board	02	6 ea
10880 Δ	12" x 18" x .5" Assortment Pack	00	1 pk
10881 Δ	12" x 18" x .5" White Board	02	6 ea
10882 Δ	12" x 18" x .5" Color Board	04, 05, 09, 14, 25, 89	6 ea
12881 Δ	12" x 18" x .75" White Board	02	3 ea
12882 Δ	12" x 18" x .75" Color Board	04, 05, 09, 14, 25	3 ea
10883 Δ	15" x 20" x .5" Assortment Pack	00	1 pk
10884 Δ	15" x 20" x .5" White Board	02	6 ea
10885 Δ	15" x 20" x .5" Color Board	04, 05, 09, 14, 25	6 ea
12886 Δ	15" x 20" x .75" White Board	02	3 ea
12887 Δ	15" x 20" x .75" Color Board	04, 05, 09, 14, 25	3 ea
10886 Δ	18" x 24" x .5" Assortment Pack	00	1 pk
10887 Δ	18" x 24" x .5" White Board	02	6 ea
10888 Δ	18" x 24" x .5" Color Board	04, 05, 09, 14, 25, 89	6 ea
12891 Δ	18" x 24" x .75" White Board	02	3 ea
12892 Δ	18" x 24" x .75" Color Board	04, 05, 09, 14, 25	3 ea
10897 Δ	24" x 24" x .5" White Board	02	6 ea
12901 Δ	24" x 24" x .75" White Board	02	3 ea
Board & Brush Racks			
11879	Professional Board & Brush Rack	03	1 ea
Sparta Spectrum Cutting Board Brushes			
40521	6" Cutting Board Brush with Polyester Bristles, 1.38" trim	02, 04, 05, 09, 14, 25, 89	12 ea
Cutting Board Scraper/Finisher Tool			
11789	Cutting Board Refinisher	02	12 ea
11799	Replacement Refinisher Blades (2 pk)	44	12 pk
Griptite Mat			
11801 Δ	Griptite 13" x 18" Cutting Board Mat	14	6 ea
Spectrum Wall Chart			
10889WC	Spectrum Color-Coded Cross-Contamination Wall Chart	00	6 ea

NSF Listed products are designated with a Δ and may be prefixed with an N



HEAT LAMPS

Heat Lamps

- Wide selection of heat lamps for both front-of-the-house buffet service and back-of-the-house temperature retention
- 1-year limited warranty

Flexiglow™

- Spun aluminum shade with flared rim for added strength
- Shade is drilled for increased heat dissipation
- Optional NSF Listed maple cutting board and drip pan is perfect for a front-of-the-house carving station
- Meets Standard Electrical Specifications shown
- Rated UL recognized

Dual Arm Flexiglow

- Two flex arms provide heating for separate products
- Vinyl-coated arms help keep unit sanitary
- Includes two 250-watt Red bulbs

Single Arm Flexiglow

- Switch located away from the heat source
- Includes 250 watt Red bulb



Two Bulb Adjustable

- Adjustable arm for different heat settings
- Spun aluminum shades with flared rim for added strength and more even heat dissipation
- Ceramic insulated sockets with nickel plated contacts to prevent fusing
- Meets Standard Electrical Specifications shown on facing page
- On/off switch mounted on arm away from heat zone
- Includes two 250-watt Clear bulbs
- UL & CSA listed



HL7237PS

Standard Electrical Specifications

- Sockets are ceramic insulated and furnished with a nickel-plated copper screw shell and contact point to prevent fusing
- Internal wiring is braided and silicone covered and rated 200°C
- Durable 16 gauge external wiring with molded three-prong plug
- All switches are either “T” or “L” rated and surpass minimum requirements
- All switches are located out of the heat zone
- Designed to operate on 110-120 volt AC service; wiring will accommodate 250 volt AC service
- Heat lamps have one year warranty against defects in materials and workmanship

Find replacement parts at
www.carlislefsp.com/replacement-parts



Prod No	Description	Color	Pack
Flexiglow Heat Lamps			
HL8285 ▲	Dual Arm Flexiglow, Aluminum, 24" Arm	00	1 ea
HL8285G ▲	Dual Arm Flexiglow, Gold, 24" Arm	21	1 ea
HL8285B** ▲	Dual Arm Flexiglow with Board & Pan, Aluminum, 24" Arm	00	1 ea
HL8285GB** ▲	Dual Arm Flexiglow with Board & Pan, Gold, 24" Arm	21	1 ea
HL8185 ▲	Flexiglow, Aluminum, 24" Arm	00	1 ea
HL8185G ▲	Flexiglow, Gold, 24" Arm	00*	1 ea
HL8185C	Flexiglow, Aluminum, 24" Arm, Includes Clamp	00	1 ea
HL8185GC	Flexiglow, Gold, 24" Arm, Includes Clamp	00*	1 ea
HL8185B** ▲	Flexiglow with Board & Pan, Aluminum, 24" Arm	00	1 ea
HL8185GB** ▲	Flexiglow with Board & Pan, Gold, 24" Arm	21	1 ea
HLA20	Flexiglow Clamp (8100 & 8200 Series)	00*	1 ea
HL8195 ▲	Flexiglow Aluminum, 39" Arm	00	1 ea
HL8195B** ▲	Flexiglow with Board, Aluminum, 39" Arm	00	1 ea
Two Bulb Adjustable Heat Lamp			
HL7237 ▲	Two Bulb Free Standing Adjustable Heat Lamp	00	1 ea
HL7237PS	Two Bulb Free Standing Adjustable Heat Lamp with 13" x 21" SS Pan & Screen	00	1 ea

NSF Listed products are designated with a ▲ and may be prefixed with an N

**Includes 18" x 26" drip pan and 16" x 24" maple cutting board

Note: To allow for choice of lamp placement, holes in board are not pre-drilled

Note: HL8185B, HL8185GB, HL8195, HL8195B, HL8285, HL8285G, HL8285B, HL8285GB can be shipped UPS/FedEx Ground at oversize cost

Note: Heat Lamps sold or shipped outside the U.S. do not include a plug or bulb(s)



ORDER WHEELS AND RACKS

Order Wheels

- Keeps orders in clear view during preparation
- Rugged stainless steel construction
- Unique ball/spring clips for easy, one-handed check placement
- Custom length (381EX) extensions available for counter and ceiling mount models

Counter Mount Model

- Wheel mounts to any counter
- 9" extension & plate included

Ceiling Hung Model

- Square "CH" plate on top of axle mounts to ceiling with 4 screws

Note: Ceiling hung model does not include an extension. Extender must be purchased separately

Wall Mounted Model

- Wheel mounts to any wall
- Extension & plate included

Pedestal Model

- Heavy chrome 10" round base won't tip
- Rubber footprint prevents slipping and protects counter tops
- Includes 9" extension for adjustable height



Find replacement parts at www.carlislefsp.com/replacement-parts

Slide Order Racks

- Ball-bearing action provides clean look & one-handed sliding action
- Choose from rugged stainless steel or economical aluminum options
- Custom lengths are available by special order



Prod No	Description	Pack
Order Wheels		
3812MP	12 Clip, 14" Portable Order Wheel	1 ea
3816MP	16 Clip, 18" Portable Order Wheel	1 ea
3820MP	20 Clip, 23" Portable Order Wheel	1 ea
3812CM	12 Clip, 14" Counter Mount Order Wheel	1 ea
3812CH	12 Clip, 14" Ceiling Hung Order Wheel	1 ea
3816CH	16 Clip, 18" Ceiling Hung Order Wheel	1 ea
3820CH	20 Clip, 23" Ceiling Hung Order Wheel	1 ea
3816WH	16 Clip, 18" Wall Mounted Order Wheel with 9" Extension	1 ea
Slide Order Racks		
38360	36" Stainless Steel Slide Order Rack	3 ea
38480	48" Stainless Steel Slide Order Rack	3 ea
38180A	18" Aluminum Slide Order Rack	3 ea
38240A	24" Aluminum Slide Order Rack	3 ea
38360A	36" Aluminum Slide Order Rack	3 ea
38480A	48" Aluminum Slide Order Rack	3 ea

IceMaster™ Ice Transport Tote

- Sturdy, high-impact material is less susceptible to cracking and breaking than other totes
- Includes molded-on Comfort Grip™ handle and side helper handle for emptying
- Helper handle doubles as drain hook
- Securely attaches upside down to edge of wire shelving or locks into mounting bracket to drain tote
- Optional mounting bracket can be attached to walls or the side of an ice bin
- Lid also available; protects against contaminants
- NSF Listed



Ice Only Container

- Safely and easily transports small loads of ice
- Perfect for filling food bars or other iced food displays, ice bins on portable bars, or even automatic ice dispensers at self-serve beverage stations
- Heavy-duty construction and ergonomic Comfort Curve™ handles provide easy handling; deep hand holds on base for controlled tipping
- Lids are reinforced and have snap down tab lock
- Imprinted on two sides in both English & Spanish
- NSF Listed



Scoops

Great economical choice for your front and back of house ice handling needs.

Metal Scoops

- Heavy-duty scoops have easy to hold pistol-grip handles with clearly marked capacities



Polycarbonate Scoops

- Easy-grip plastic handle doesn't transfer cold
- Features a hole for hanging or tying to a container
- Durable polycarbonate material
- NSF Listed; dishwasher safe

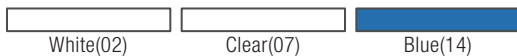

Prod No	Description	Color	Pack
Scoops			
606040	38 oz Solid Cast Aluminum Scoop	—	12 ea
606055	58 oz Solid Cast Aluminum Scoop	—	12 ea
606086	85 oz Solid Cast Aluminum Scoop	—	12 ea
4306 Δ	6 oz Polycarbonate Scoop	07	12 ea
4332 Δ	32 oz Polycarbonate Scoop	07	12 ea
4364 Δ	64 oz Polycarbonate Scoop	07	6 ea
IceMaster Ice Transport Tote & Accessories			
12875 Δ	IceMaster Ice Transport	02	2 ea
12876	IceMaster Lid	14	1 ea
12877	IceMaster Wall Bracket	14	1 ea
Ice Only Container & Lid			
341010ICE Δ	10 gal Ice Only Container	02	6 ea
341011	10 gal Ice Only Container Lid	02	6 ea

NSF Listed products are designated with a Δ and may be prefixed with an N



SPARTA® PASTRY & BASTING BRUSHES

Sparta Pastry & Basting Brushes have been the **top choice** of discriminating professional chefs the world over for decades. The **high quality craftsmanship** provides the **best bristle retention in the industry**. You should never sacrifice food safety and with our wide selection of brushes, we have a brush to cover **all of your needs**.



TOP SELLER

SPARTA®
BRUSH
Famous for Quality

Other Brands

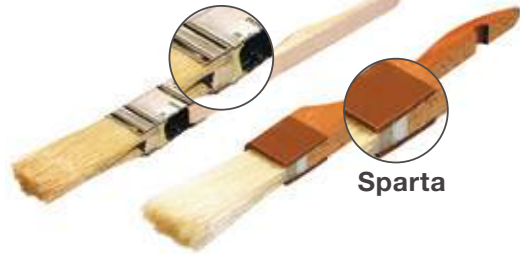

Sparta

Superior Food Safety Construction

Epoxy-set ferrules on all Sparta Pastry/Basting Brushes are especially designed for foodservice use; eliminating hazardous bacteria traps commonly found in other brushes. Sparta Pastry/Basting Brushes are available in a wide range of sizes and styles.

Chef Series™ Brushes

- Professional, high-quality lacquered hardwood handles with brown plastic ferrules are the choice of top chefs
- Bristles are epoxy-set to ferrules to provide superior bristle retention and to prevent bacteria harboring air pockets

Sparta Chef Series Croissant Brush

- Extra long bleached boar bristles for use on the most delicate of pastries and foods



Chef Series Basting Brushes

- The professional's choice for use in basting meats and poultry
- Durable sterilized, double-boiled, bleached boar bristles
- Withstands temperatures of up to 500°F

Note: Basting brushes should not be cleaned in dishwashers. Brushes should be dipped in a commercial cleaning solution and rinsed.



For usage information on these and other brushes included in our 21 Key Brushes Set, check out our 21 Key Brush Guide on pages 253-255

Standard(00)

Prod No	Description	Color	Pack
Sparta Chef Series Croissant Brush			
40377	1.5" Wide Brush with Boar Bristles	00	12 ea
Sparta Chef Series Basting Brushes			
40370	12" Handle with 2" Wide Brush with Boar Bristles	00	12 ea
40371	12" Handle with 4" Wide Brush with Boar Bristles	00	12 ea
40372	1" Wide Flat Brush with Boar Bristles	00	12 ea
40373	1.5" Wide Flat Brush with Boar Bristles	00	12 ea
40374	2" Wide Flat Brush with Boar Bristles	00	12 ea
40375	3" Wide Flat Brush with Boar Bristles	00	12 ea
40376	4" Wide Flat Brush with Boar Bristles	00	12 ea
40380	1" Round Brush with Boar Bristles	00	12 ea



Chef Series Pastry Brushes

- Soft, flagged, white nylon bristles have high fluid retaining capacity and provide a soft touch to delicate pastries
- The finest commercial brushes of their kind
- Offers the performance, delicate touch, and long-lasting value by which all others are judged



Meteor Pastry/Basting Brushes

- “Molded-into-the-handle” hook hangs on lip of crocks and containers to prevent bristle burn, melt, or distortion
- Use hook to elevate bristles off of counter tops
- Soft flagged bristles are molded into handle to prevent bacteria harboring air pockets
- Available with white nylon bristles or double-boiled, bleached, sterilized, premium boar bristles

Hook hangs on side of crock or elevates bristles off counter tops



Bristles | Heat Distortion Point

Synthetic	Up to 350°F (176.7°C)
Boar	500°F (260°C)
Silicone	500°F (260°C)



Prod No	Description	Color	Pack
Sparta Chef Series Pastry Brushes			
40395	1" Wide Brush with Nylon Bristles	—	12 ea
40396	1.5" Wide Brush with Nylon Bristles	—	12 ea
40397	2" Wide Brush with Nylon Bristles	—	12 ea
40398	3" Wide Brush with Nylon Bristles	—	12 ea
40399	4" Wide Brush with Nylon Bristles	—	12 ea
40400	1" Round Brush with Nylon Bristles	—	12 ea
Sparta Meteor Pastry/Basting Brushes			
40378	2" Wide Brush with Boar Bristles	—	12 ea
40379	3" Wide Brush with Boar Bristles	—	12 ea
40401	2" Wide Brush with Nylon Bristles	02, 14	12 ea
40402	3" Wide Brush with Nylon Bristles	02, 14	12 ea



SPARTA® PASTRY & BASTING BRUSHES

Galaxy™ Pastry Brushes

- Bristles are epoxy-set to prevent bacteria harboring air pockets
- One piece plastic handles are easy to clean
- Available with soft flagged nylon bristles
- Select brushes also available with blue nylon bristles for added contrast in working with white frostings or other white foods



Silicone Basting Brush

- Dishwasher safe
- Unique bristle design carries and spreads liquid better than ordinary Silicone basting brushes
- Withstands temperatures up to 500°F
- Convenient molded-in hanging hook grabs pan edges to keep brush from sliding in
- Stain and odor resistant



Prod No	Description	Color	Pack
Sparta Galaxy Pastry Brushes			
40390	1.5" Wide Flat Brush with Nylon Bristles	02	12 ea
40391	2" Wide Flat Brush with Nylon Bristles	02, 14	12 ea
40392	3" Wide Flat Brush with Nylon Bristles	02, 14	12 ea
40393	4" Wide Flat Brush with Nylon Bristles	02, 14	12 ea
40394	1" Round Brush with Nylon Bristles	02	12 ea
Silicone Basting Brushes			
40403	2" Silicone Basting Brush	05	12 ea
40405	3" Silicone Basting Brush	05	12 ea

Food Preparation Brushes

Potato Brush

- Patented brush has stiff polyester bristles for aggressive cleaning along with a unique “scraper edge” grip for removing hard to reach blemishes on potatoes and other firm vegetables



Vegetable Brush

- Round loop construction, straight handle with firm bristles



Portioning Cups

- Scoop or transfer ice, liquids, or any bulk item
- Features flat sides for efficient scooping on the bottom of bins, food pans, or other storage containers
- Made of durable, break-resistant polycarbonate
- Unique U-shaped handle helps keep hands away from food contact areas while scooping
- Sizes are color coded for quick and easy identification
- NSF Listed; dishwasher safe



One Gallon Container

- Ideal for mixing batters, dressings, and drinks
- Assorted color toggle lids allow easy access for quick open and close action and color identification
- Tight sealing lid protects against spills
- Durable translucent polypropylene material makes it easy to see contents
- U.S. and metric measurements printed on side panels
- NSF Listed; dishwasher safe



Standard(00)	Brown(01)	White(02)	Black(03)	Beige(06)
--------------	-----------	-----------	-----------	-----------

Prod No	Description	Color	Pack
Sparta Food Preparation Brushes			
40412	5.75" Potato Brush with Medium Stiff Polyester Bristles	02	12 ea
40164	9.5" Vegetable Brush with Stiff Polyester Bristles	02	12 ea
Portioning Cups			
49110-1 Δ	9.5 oz Portion Cup	02	6 ea
49112-1 Δ	12 oz Portion Cup	06	6 ea
49116-1 Δ	16 oz Portion Cup	01	6 ea
49122-1 Δ	20 oz Portion Cup	03	6 ea
One Gallon Container & Toggles			
6400 Δ	1 Gallon Container	00	2 ea
6401 Δ	Replacement Lid & Assorted Toggles	00	6 ea

NSF Listed products are designated with a Δ and may be prefixed with an N



MEASURES & SERVING ACCESSORIES

Commercial Measures

- Made of durable polycarbonate
- Offers easy measuring of wet ingredients
- Available in Cup, Pint, Quart, Half Gallon and Gallon sizes with U.S. and metric measurements
- Oval shape facilitates pouring from non-spouted side
- Family of measurers nest for storage
- NSF Listed; dishwasher safe



Overhead view of inside measuring lines allow for a faster, more accurate measurement.



Chef Series™ Measuring Cups

- Extra-heavy-duty construction for the most demanding professional use
- Rust-free 18-8 stainless



Measuring Cup

- Durable polycarbonate with 1-cup capacity for measuring liquid ingredients
- Withstands temperatures from -40° to 212°F
- Dishwasher safe



Prod No	Description	Color	Pack
Commercial Measures			
43141 ▲	Cup Size PC Measure	07, AF07	12 ea
43142 ▲	Pint Size PC Measure	07, AF07	6 ea
43143 ▲	Quart Size PC Measure	07, AF07	6 ea
43144 ▲	Half Gallon Size PC Measure	07, AF07	6 ea
43145 ▲	Gallon Size PC Measure	07, AF07	6 ea
Chef Series Measuring Cups			
604310	Chef Series Heavy-Weight Measuring Cup Set	—	12 ea
Measuring Cup			
4315	Measuring Cup	07	6 ea

NSF Listed products are designated with a ▲ and may be prefixed with an N



Dishers

- Color-coded for easy identification and portion control
- Smooth operating 18-8 stainless steel construction with ribbed plastic handle
- Bowl capacity is stamped on bail
- Number on bail indicates scoops per quart
- NSF Listed; dishwasher safe



Stainless Steel Measure Misers®

- Portion control spoons in heavy gauge 18-8 stainless steel with durable one-piece construction
- Feature color-coded Kool-Touch handles and built-in pan edge rest
- Dishwasher safe



Prod No **Description** **Pack**

Dishers

60300-6 Δ	4.66 oz Disher with White Handle	12 ea
60300-8 Δ	4 oz Disher with Gray Handle	12 ea
60300-10 Δ	3.75 oz Disher with Ivory Handle	12 ea
60300-12 Δ	3.25 oz Disher with Green Handle	12 ea
60300-16 Δ	2.75 oz Disher with Blue Handle	12 ea
60300-20 Δ	2 oz Disher with Yellow Handle	12 ea
60300-24 Δ	1.75 oz Disher with Red Handle	12 ea
60300-30 Δ	1.25 oz Disher with Black handle	12 ea
60300-40 Δ	.88 oz Disher with Orchid handle	12 ea

Stainless Steel Measure Misers

604358	1 oz Solid SS Measure Miser, Yellow	12 ea
604359	1 oz Perforated SS Measure Miser, Yellow	12 ea
604360	2 oz Solid SS Measure Miser, Red	12 ea
604361	2 oz Perforated SS Measure Miser, Red	12 ea
604370	3 oz Solid SS Measure Miser, Beige	12 ea
604371	3 oz Perforated SS Measure Miser, Beige	12 ea
604380	4 oz Solid SS Measure Miser, Green	12 ea
604381	4 oz Perforated SS Measure Miser, Green	12 ea
604390	6 oz Solid SS Measure Miser, Black	12 ea
604392	8 oz Solid SS Measure Miser, Blue	12 ea

NSF Listed products are designated with a Δ and may be prefixed with an N



MEASURE MISERS®

Measure Misers help your kitchen **deliver consistency** to make work easier and **save you money.**

Measure Misers

- Portion control spoon made of break-resistant polycarbonate
- Spoon's flat bottom easily spreads sauces or toppings
- Long handle measure misers have thumb grip for steady control and a notch for resting on pan rim
- Recommended for temperatures up to 212°F; withstands dry heat up to 270°F
- 2-year limited warranty
- NSF Listed; dishwasher safe



Prod No	Description	Color	Pack
Measure Misers			
Short Handle			
4322 Δ	1-1/2 oz, 7.19" Solid Measure Miser w/Red Measurements	06	12 ea
4324 Δ	2 oz, 7.13" Solid Measure Miser w/Red Measurements	06	12 ea
4362 Δ	2 oz, 7.13" Perforated Measure Miser w/Red Measurements	06	12 ea
4326 Δ	3 oz, 8" Solid Measure Miser w/Blue Measurements	06	12 ea
4328 Δ	4 oz, 8.25" Solid Measure Miser w/Green Measurements	06	12 ea
4329 Δ	4 oz, 8.25" Perforated Measure Miser w/Green Measurements	06	12 ea
4330 Δ	6 oz, 8.63" Solid Measure Miser w/Black Measurements	06	12 ea
Standard Handle			
4358 Δ	1-1/2 oz, 11.94" Solid Measure Miser w/Maroon Measurements	06	12 ea
4360 Δ	2 oz, 11.94" Solid Measure Miser w/Red Measurements	06	12 ea
4361 Δ	2 oz, 11.94" Perforated Measure Miser w/Red Measurements	06	12 ea
4370 Δ	3 oz, 12.75" Solid Measure Miser w/Blue Measurements	06	12 ea
4371 Δ	3 oz, 12.75" Perforated Measure Miser w/Blue Measurements	06	12 ea
4380 Δ	4 oz, 13" Solid Measure Miser w/Green Measurements	06	12 ea
4381 Δ	4 oz, 13" Perforated Measure Miser w/Green Measurements	06	12 ea
4390 Δ	6 oz, 13.38" Solid Measure Miser w/Black Measurements	06	12 ea
4391 Δ	6 oz, 13.38" Perforated Measure Miser w/Black Measurements	06	12 ea
Black Measure Misers*			
4360-5 Δ	2 oz, 11.94" Solid Measure Miser	03	12 ea
4370-5 Δ	3 oz, 12.75" Solid Measure Miser	03	12 ea
4380-5 Δ	4 oz, 13" Solid Measure Miser	03	12 ea
4381-5 Δ	4 oz, 13" Perforated Measure Miser	03	12 ea
4390-5 Δ	6 oz, 13.38" Solid Measure Miser	03	12 ea

NSF Listed products are designated with a Δ and may be prefixed with an N
 *Black measure misers do not have color-coding



Long lasting acetal Color-Coded Measure Misers ensure employees **deliver the consistency** your customers expect without compromising durability.

Color-Coded Measure Misers®

- Portion control spoon made of break-resistant acetal material
- Each color represents a different size for easy recognition and consistency
- Spoon's flat bottom easily spreads sauces or toppings
- Long handle measure misers have thumb grip for steady control and a notch for resting on pan rim
- Recommended for temperatures up to 212°F; withstands dry heat up to 270°F
- BPA Free
- 2-year limited warranty
- NSF Listed; dishwasher safe

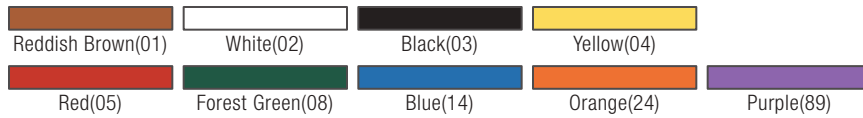

Prod No	Description	Color	Pack
Color-Coded Measure Misers			
Short Handle			
4921 Δ	1 oz, 6.5" Solid Spoon	04, 89	12 ea
4923 Δ	1 oz, 6.5" Perforated Spoon	04	12 ea
4922 Δ	1.5 oz, 7" Solid Spoon	01	12 ea
4961 Δ	1.5 oz, 7" Perforated Spoon	01	12 ea
4924 Δ	2 oz, 7.10" Solid Spoon	05, 89	12 ea
4962 Δ	2 oz, 7.10" Perforated Spoon	05, 89	12 ea
4925 Δ	2.5 oz, 7.10" oz Solid Spoon	24	12 ea
4963 Δ	2.5 oz, 7.10" Perforated Spoon	24	12 ea
4926 Δ	3 oz, 8" Solid Spoon	02, 89	12 ea
4928 Δ	4 oz, 8.25" Solid Spoon	08, 89	12 ea
4929 Δ	4 oz, 8.25" Perforated Spoon	08	12 ea
4930 Δ	6 oz, 8.62" Solid Spoon	03, 89	12 ea
4931 Δ	8 oz, 8.62" Solid Spoon	14	12 ea
Long Handle			
3956 Δ	1 oz, 11.5" Solid Spoon	04, 89	12 ea
3957 Δ	1 oz, 11.25" Perforated Spoon	04	12 ea
3958 Δ	1.5 oz, 11.5" Solid Spoon	01	12 ea
3959 Δ	1.5 oz, 11.5" Perforated Spoon	01	12 ea
3960 Δ	2 oz, 11.9" Solid Spoon	05, 89	12 ea
3961 Δ	2 oz, 11.9" Perforated Spoon	05	12 ea
3970 Δ	3 oz, 11.75" Solid Spoon	02	12 ea
3971 Δ	3 oz, 11.75" Perforated Spoon	02	12 ea
3980 Δ	4 oz, 13" Solid Spoon	08, 89	12 ea
3981 Δ	4 oz, 13" Perforated Spoon	08, 89	12 ea
3990 Δ	6 oz, 13.4" Solid Spoon	03	12 ea
3991 Δ	6 oz, 3.4" Perforated Spoon	03	12 ea
3992 Δ	8 oz, 13.25" Solid Spoon	14	12 ea
3993 Δ	8 oz, 13.25" Perforated Spoon	14	12 ea

NSF Listed products are designated with a Δ and may be prefixed with an N



COLANDERS, BOWLS, DREDGES & SKIMMERS

Colanders

- Seamless satin finish aluminum construction with rolled top edge for extra strength
- Sturdy handles are securely riveted on sides
- Available in extra heavy or standard gauge aluminum



Melamine Mixing Bowls

- Heavy-duty melamine is safe for temperatures up to 212°F
- Bowls are break and stain-resistant
- Not recommended for microwave use
- Dishwasher safe



Prod No	Description	Color	Pack
Colanders			
60275	11 qt Heavy-Weight Colander	—	6 ea
60277	16 qt Heavy-Weight Colander	—	6 ea
60278	8 qt Standard Weight Colander	—	6 ea
60279	11 qt Standard Weight Colander	—	6 ea
60280	16 qt Standard Weight Colander	—	6 ea
Melamine Mixing Bowls			
43744	1.5 qt, 8" Mixing Bowl	02, 92	12 ea
43743	3 qt, 9.75" Mixing Bowl	02, 92	12 ea

Metal Dredge

- Heavy-duty seamless dredges in aluminum
- 18-8 mirror polish stainless with wide screw tops for easy filling
- Dishwasher safe



Shaker/Dredge

- Durable break-resistant polycarbonate shaker can be customized with your logo
- Call Customer Service at 1-800-654-8210 for custom imprinting information
- Additional lids can be purchased separately to accommodate different toppings



Wire Mesh Skimmers

- Heavy-duty construction
- Skimmers lift food from fryer
- Sturdy handles with hanging loops
- Nickel plated construction resists corrosion



Prod No	Description	Color	Pack
Metal Dredge			
6031	Alumilite Dredge with Handle	—	12 ea
Polycarbonate Shaker/Dredge & Lids			
4250	Dredge with Medium Ground, Rose Lid	55	12 ea
4260	Dredge with Cheese, Yellow Lid	04	12 ea
4270	Dredge with Salt & Pepper, Beige Lid	06	12 ea
4230	Dredge with Translucent Parsley Lid	30	12 ea
4231	Translucent Parsley Lid	30	12 ea
4251	Rose Medium Ground Lid	55	12 ea
4261	Yellow Cheese Lid	04	12 ea
4271	Beige Salt & Pepper Lid	06	12 ea
Wire Mesh Skimmers			
601526	6" Bowl Mesh Skimmer	—	12 ea
601527	7" Bowl Mesh Skimmer	—	12 ea
601528	8" Bowl Mesh Skimmer	—	12 ea
601529	9" Bowl Mesh Skimmer	—	12 ea

NSF Listed products are designated with a **Δ** and may be prefixed with an N



SPATULAS & SCRAPERS

Sparta® Spatulas & Paddle Scrapers

- Perfect for general mixing and stirring
- Long handle versions are ideal for vats and large pots
- Stainless steel or nylon/polyethylene scraper available
- Smooth finish, water-proof construction for easy clean-up
- Replacement blades are available for this product



Prod No	Description	Color	Pack
Sparta Spatulas & Paddle Scrapers			
40347 ▲	36" Stainless Steel Paddle Scraper	—	6 ea
40349 ▲	48" Stainless Steel Paddle Scraper	—	6 ea
40359 ▲	60" Stainless Steel Paddle Scraper	—	6 ea
40350	13.5" Nylon Handle with 4.5" x 7.5" Nylon Spatula Scraper	02	6 ea
40351	13.5" Nylon Handle with 4.5" x 7.5" Polyethylene Soft Spatula Scraper	00	6 ea
40352	40" Nylon Handle with 4.5" x 7.5" Nylon Paddle Scraper	02	6 ea
40353	48" Nylon Handle with 4.5" x 7.5" Nylon Paddle Scraper	00	6 ea
40354	48" Stainless Steel Handle with 4.5" x 7.5" Nylon Paddle Scraper	00	6 ea
40355	72" Stainless Steel Handle with 4.5" x 7.5" Nylon Paddle Scraper	00	6 ea
40356	48" Stainless Steel Handle with 6.5" x 9" Nylon Paddle Scraper	00	3 ea
40361	4.5" x 7" Standard Nylon Replacement Blade	02	6 ea
40362	6.5" x 9" Large Nylon Replacement Blade	00	6 ea

NSF Listed products are designated with a ▲ and may be prefixed with an N

Spatulas & Scrapers

- Completely eliminate unsanitary food traps with the over-molded blade and handle design
- Fine-edge tapered profile of the spatula is perfect for spreading
- Sharp edge and deep bowl of the Scraper reduces waste by helping you scoop out every last drop
- Red handled high-heat versions are rated to 600°F and feature cool-touch handles



White(02)

Prod No	Description	Color	Pack
Spatulas & Scrapers			
44141	10" Spatula	02	12 ea
44142	14" Spatula	02	12 ea
44143	16" Spatula	02	12 ea
44144	10" Scraper	02	12 ea
44145	14" Scraper	02	12 ea
44146	16" Scraper	02	12 ea
44131	10.5" High Heat Spatula	02	12 ea
44132	14" High Heat Spatula	02	12 ea
44133	16.25" High Heat Spatula	02	12 ea
44134	10.5" High Heat Scraper	02	12 ea
44135	14" High Heat Scraper	02	12 ea
44136	16.25" High Heat Scraper	02	12 ea



TONGS, WHIPS & TOOLS

Tongs

Heavy-Duty Utility Tongs

- Heavy 20 gauge stainless steel with flat spring for long-lasting service
- Dishwasher safe

Spectrum® Dura-Kool™ Tongs

- Color-coded Dura-Kool handles provide easy visual for zone isolation
- Single-piece, heavy-duty stainless steel construction eliminates food traps for more sanitary use
- Spring action hinge won't break, also provides convenient hook for storage

Carlisle's Spectrum System supports your HACCP program by promoting zone isolation and reducing the risk of cross-contamination with our complete offering of color-coded kitchen tools and cleaning accessories



Sparta® Chef Series™ French Whips

- Sanitary fully-sealed construction eliminates bacteria harboring food traps
- Rust-free 18-8 stainless construction with heavy gauge spring wire loops
- Perfectly weighted and balanced for heavy mixing, stirring, and beating batters, sauces, and other thicker mixtures



Prod No	Description	Color	Pack
Heavy-Duty Utility Tongs			
607550	9.5" Heavy-Duty Utility Tongs	—	12 ea
607552	12" Heavy-Duty Utility Tongs	—	12 ea
607556	16" Heavy-Duty Utility Tongs	—	12 ea
Spectrum Dura-Kool Tongs			
607560 ▲	9.5" Spectrum Dura-Kool Tong	03, 04, 05, 09, 14	12 ea
607562 ▲	12" Spectrum Dura-Kool Tong	03, 04, 05, 09, 14	12 ea
607566 ▲	16" Spectrum Dura-Kool Tong	03, 05, 09, 14	12 ea
Sparta Chef Series French Whips			
40683	18" Chef Series Heavy-Weight French Whip	—	2 ea
40681	36" Chef Series Heavy-Weight French Whip	—	2 ea
40682	48" Chef Series Heavy-Weight French Whip	—	2 ea

NSF Listed products are designated with a ▲ and may be prefixed with an N

High Heat Serving Spoons & Turner

- High heat material withstands temperatures from -40°F to 375°F without melting or transferring heat
- Helps prevent scratching on coated surfaces
- Notched handle with hole for hanging
- NSF Listed; dishwasher safe

High Heat Serving Spoons

- Notched handle allows spoon to rest on edge of food pan



Oil Bottle & Sprayer

- 16 oz capacity to keep oil fresh
- Amber color protects light sensitive oils
- Value alternative to aerosol cans of oil
- Pre-labeled to ensure segregation from cleaning bottles
- Thread is compatible with standard sprayers

Sprayer (sold separately)

- Adjustable spray nozzle
- Metered application reduces food waste and improves consistency



Sparta® Foodservice Shovels

- Heavy duty one-piece plastic construction
- Supports heavy loads, safe to use with food, will not rust, and cleans up easily



Prod No	Description	Color	Pack
High Heat Serving Spoons & Turner			
4415 Δ	11" Solid High Heat Serving Spoon	03, 15	12 ea
4416 Δ	11" Perforated High Heat Serving Spoon	03, 15	12 ea
4425 Δ	13" Solid High Heat Serving Spoon	03, 15	12 ea
4426 Δ	13" Perforated High Heat Serving Spoon	03, 15	12 ea
4900 Δ	13" Slotted Turner	03, 15	12 ea
Oil Bottle & Sprayer			
3816	16 oz Amber Bottle with Label	13	12 ea
3817	Trigger Sprayer	00	12 ea
Sparta Foodservice Shovels			
41076-1	11" Wide Foodservice Shovel	02	1 ea
41076	11" Wide Foodservice Shovel	02, 04, 05	6 ea
41077-1	14" Wide Foodservice Shovel	02	1 ea
41077	14" Wide Foodservice Shovel	02, 04, 05	6 ea

NSF Listed products are designated with a Δ and may be prefixed with an N



CARLISLE
FOODSERVICE PRODUCTS

TOUGH VERSATILE SAFE INNOVATIVE **STORAGE & HANDLING SUPPLIES**

From distinct color-coding to easy-clean surfaces, Carlisle ensures that all of our products are designed to safely store, handle and transport food. You can count on Carlisle to help you keep food fresh, reduce food safety risks, reduce waste, and operate efficiently



STORPLUS™

COMPLETE STORAGE SOLUTIONS

Only Carlisle offers such a wide selection of storage containers for your foodservice operation.

All StorPlus products offer the quality construction and ease of use Carlisle is known for. They are tough and durable, plus these NSF Listed products are designed to support your HACCP program. Product features are detailed in this catalog section.



Food Pans, Lids & Accessories

Polycarbonate, BPA Free High Heat,
BPA Free Polypropylene



Coldmaster®

Innovative products that are a perfect compliment to your StorPlus containers

See pages 108-115 for a complete listing



EZ Access Lids

Efficient and convenient flip hinge lid that keeps food safe

See pages 218-220 for a complete listing



Specialty Handled High Heat

Help products stay warm and fresh for your customers

See pages 221 for a complete listing





6" Deep 1/9 Size

Offer A **50% Larger** Assortment
With **35% Less** Footprint



Storage Boxes & Lids

Color-Coded For All Your Storage Needs



Squares & Rounds

Easy-To-Read **Capacity Indicators**
Built-In Handles

3 Options

Carlisle Offers Three
Food Pan Options

Polycarbonate, High
Heat, Stainless Steel





STORPLUS™ FOOD PANS

StorPlus is a whole house storage and handling solution. It provides **safety** and **efficiency**. The Universal Food Pan Lids fit all major brands, helping to **lower inventory**. Use these products that only Carlisle offers and **make work easy**.

- Textured non-slip finish on corners, sides, bottom, and lid to reduce scratches
- Smooth interior finish makes clean-up easy
- Polycarbonate containers can withstand temperatures from -40°F to 212°F
- High-heat pans excel in high temperature applications and are BPA Free (-40°F to 375°F)
- Food Pan sizes meet specifications for use in food bars and steam tables
- Pans meet EN 631-1 Euro Norm standards for inter-stacking with existing pans
- NSF Listed; dishwasher safe

Food Pans

- Reinforced top and bottom corners on both pan and lid help prevent chipping and cracking
- Spoonable bottom makes removal of contents easier and helps prevent food waste
- Molded-in capacity indicators are listed in both quarts and liters



EZ Access Lids

- 50%-60% larger opening, ensuring employees have quick and efficient access to the food in the pan
- Fit snugly onto food pans, ensuring they do not pop off when leveling a measure miser on the sidewall for proper portioning
- Integrated double-hinged design
- NSF Listed; dishwasher safe



Universal Food Pan Lids

- Fit Carlisle StorPlus Food Pans as well as other major brands on the market
- Features a hanging hole for easy storage
- Fits both Gastronorm and standard size food pans
- Carlisle lids stack with themselves for easy storage
- Available in polycarbonate or high heat material
- NSF Listed; dishwasher safe



Smart Lids™

- Unique inside seal design provides superior leak-resistance and keeps your foods fresher, longer
- Perfect for transporting foods to off site locations
- Smart Lids (combined with StorPlus Food Pans) fit inside Cateraide Top Loaders and End Loaders (shown on pages 168-175)
- Polyethylene material is dishwasher safe; for use in -40°F to 180°F
- Designed exclusively to fit StorPlus Food Pans

Smart Lid's unique inside seal design provides superior leak-resistance; protects against spills





High Heat

StorPlus High Heat Food Pans provide the single container solution for cold storage, flash-freezing, microwave preheat/cooking, and prolonged high temperature retention in steam table applications.



6" Deep

Perfect for your toppings bar! 1/9 size food pans allow you a 50% larger assortment over 1/4 size pans. These pans have a similar capacity to our 4" deep 1/4 size food pans with 35% less footprint.



Catering

StorPlus Food Pans fit Carlisle Cateraides™ (see pages 168-175) and other standard transport containers for off site catering, company lunches, etc.

Use StorPlus Food Pans with Maximizer™, Six★Star™, and Five★Star™ Food Bars shown on pages 122-124 and with Cateraides shown on pages 168-175





STORPLUS™ FOOD PANS AND LIDS

Polycarbonate Food Pans & Lids

- Polycarbonate pans and lids withstand tough use
- Resists food acids and oils; and can withstand temperatures of -40°F to 212°F
- For a leak-resistant seal use Smart Lids

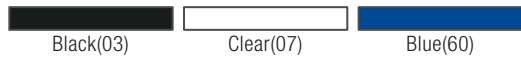

Prod No	Description	Color	Pack
Full-Size – 20.75" x 12.75"			
10200B Δ	Pan – 2.5" (7.6 qt)	03, 07	6 ea
10201B Δ	Pan – 4" (12.7 qt)	03, 07	6 ea
10202B Δ	Pan – 6" (19.4 qt)	03, 07	6 ea
10203B Δ	Pan – 8" (25.9 qt)	03, 07	6 ea
10215 Δ	Drain Shelf	07	6 ea
Lids – Fits All Full-Size Pans			
10212B	Smart Lid	60	6 ea
10210U Δ	Handled Lid	07	6 ea
10211U Δ	Handled Notched Lid	07	6 ea
10216U Δ	Flat Lid	07	6 ea
10217U Δ	Flat Notched Lid	07	6 ea
One-Half Size – 12.75" x 10.38"			
10220B Δ	Pan – 2.5" (3.6 qt)	03, 07	6 ea
10221B Δ	Pan – 4" (5.6 qt)	03, 07	6 ea
10222B* Δ	Pan – 6" (8.7 qt)	03, 07	6 ea
10223B Δ	Pan – 8" (11.4 qt)	07	6 ea
10235 Δ	Drain Shelf	07	6 ea

Prod No	Description	Color	Pack
EZ Access Lids – One Half Size			
10238Z Δ	Handled Lid	07	6 ea
10239Z Δ	Handled Notched Lid	07	6 ea
10240Z Δ	Handled Lid with Double Notch	07	6 ea
Lids – Fits All One-Half Size Pans			
10232B	Smart Lid	60	6 ea
10230U Δ	Handled Lid	07	6 ea
10231U Δ	Handled Notched Lid	07	6 ea
10236U Δ	Flat Lid	07	6 ea
One-Half Long Size – 20.75" x 6.25"			
10240B Δ	Pan – 2.5" (2.9 qt)	03, 07	6 ea
10241B Δ	Pan – 4" (5.1 qt)	03, 07	6 ea
Lids – Fits All One-Half Long Size Pans			
10250U Δ	Handled Lid	07	6 ea
10256U Δ	Flat Lid	07	6 ea
10257U Δ	Flat Notched Lid	07	6 ea

NSF Listed products are designated with a Δ and may be prefixed with an N



EZ Access Lids

- Clear EZ Access food pan lids offer convenient, hands-free operation
- Prevent cross-contamination and retain food freshness
- Handle for easy gripping, cleaning, and drying
- Polycarbonate resists food acids and oils
- NSF Listed; dishwasher safe



**NEW
PRODUCT**



Prod No	Description	Color	Pack
One-Third Size – 12.75" x 7"			
30660 Δ	Pan – 2.5" (2.4 qt)	03, 07	6 ea
30661 Δ	Pan – 4" (3.8 qt)	03, 07	6 ea
30662 Δ	Pan – 6" (5.7 qt)	03, 07	6 ea
30669 Δ	Pan – 8" (7.3 qt)	03, 07	6 ea
30670 Δ	Drain Shelf	07	6 ea

EZ Access Lids – One Third Size			
10278Z Δ	Handled Lid	07	6 ea
10279Z Δ	Handled Notched Lid	07	6 ea
10280Z Δ	Handled Lid with Notch	07	6 ea

Lids – Fits All One-Third Size Pans			
30580	Smart Lid	60	6 ea
10270U Δ	Handled Lid	07	6 ea
10271U Δ	Handled Notched Lid	07	6 ea
10276U Δ	Flat Lid	07	6 ea
10277U Δ	Flat Notched Lid	07	6 ea

One-Quarter Size – 10.25" x 6.38"			
30680 Δ	Pan – 2.5" (1.7 qt)	03, 07	6 ea
30681 Δ	Pan – 4" (2.8 qt)	03, 07	6 ea
30682 Δ	Pan – 6" (4.0 qt)	03, 07	6 ea
30695 Δ	Drain Shelf	07	6 ea

Lids – Fits All One-Quarter Size Pans			
30581	Smart Lid	60	6 ea
10290U Δ	Handled Lid	07	6 ea
10291U Δ	Handled Notched Lid	07	6 ea
10296U Δ	Flat Lid	07	6 ea
10297U Δ	Flat Notched Lid	07	6 ea

Prod No	Description	Color	Pack
One-Sixth Size – 6.75" x 6.38"			
30683 Δ	Pan – 2.5" (1.1 qt)	03, 07	6 ea
30684 Δ	Pan – 4" (1.7 qt)	03, 07	6 ea
30685 Δ	Pan – 6" (2.5 qt)	03, 07	6 ea
30689 Δ	Drain Shelf	07	6 ea

EZ Access Lids – One Sixth Size			
10318Z Δ	Handled Lid	07	6 ea
10319Z Δ	Handled Notched Lid	07	6 ea

Lids – Fits All One-Sixth Size Pans			
30582	Smart Lid	60	6 ea
10310U Δ	Handled Lid	07	6 ea
10311U Δ	Handled Notched Lid	07	6 ea
10316U Δ	Flat Lid	07	6 ea
10317U Δ	Flat Notched Lid	07	6 ea

One-Ninth Size – 6.75" x 4.25"			
30686 Δ	Pan – 2.5" (0.7 qt)	03, 07	6 ea
30687 Δ	Pan – 4" (1.0 qt)	03, 07	6 ea
30688 Δ	Pan – 6" (1.4 qt)	03, 07	6 ea
10335 Δ	Drain Shelf	07	6 ea

EZ Access Lids – One Ninth Size			
10338Z Δ	Handled Lid	07	6 ea
10339Z Δ	Handled Notched Lid	07	6 ea

Lids – Fits All One-Ninth Size Pans			
30583	Smart Lid	60	6 ea
10336U Δ	Flat Lid	07	6 ea

NSF Listed products are designated with a Δ and may be prefixed with an N



High Heat Food Pans & Lids

- High heat pans excel in high temperature applications (-40°F to 375°F)
- For a leak-resistant seal use Smart Lids



Black(03)	Amber(13)	Blue(60)		
Prod No	Description	Color	Pack	
Full-Size – 20.75" x 12.75"				
10400B Δ	Pan – 2.5" (7.6 qt)	03, 13	6 ea	
10401B Δ	Pan – 4" (12.7 qt)	03, 13	6 ea	
10402B Δ	Pan – 6" (19.4 qt)	03, 13	6 ea	
10415 Δ	Drain Shelf	13	6 ea	
Lids – Fits All Full-Size Pans				
10212B	Smart Lid	60	6 ea	
10410U Δ	Handled Lid	13	6 ea	
10411U Δ	Handled Notched Lid	13	6 ea	
10416U Δ	Flat Lid	13	6 ea	
10417U Δ	Flat Notched Lid	13	6 ea	
One-Half Size – 12.75" x 10.38"				
10420B Δ	Pan – 2.5" (3.6 qt)	03, 13	6 ea	
10421B Δ	Pan – 4" (5.6 qt)	03, 13	6 ea	
10422B Δ	Pan – 6" (8.7 qt)	03, 13	6 ea	
10423B Δ	Pan – 8" (11.4 qt)	03, 13	6 ea	
10435 Δ	Drain Shelf	13	6 ea	
EZ Access Lids – One Half Size				
10438Z Δ	EZ Access Lid	13	6 ea	
10439Z Δ	EZ Access Lid Notched	13	6 ea	
10440Z	EZ Access Lid Double Notched	13	6 ea	
Lids – Fits All One-Half Size Pans				
10232B	Smart Lid	60	6 ea	
10430U Δ	Handled Lid	13	6 ea	
10431U Δ	Handled Notched Lid	13	6 ea	
10436U Δ	Flat Lid	13	6 ea	
10437U Δ	Flat Notched Lid	13	6 ea	
One-Half Long Size – 20.75" x 6.25"				
10440B Δ	Pan – 2.5" (2.9 qt)	03, 13	6 ea	
10441B Δ	Pan – 4" (5.1 qt)	03, 13	6 ea	
Lids – Fits All One-Half Long Size Pans				
10450U Δ	Handled Lid	13	6 ea	
10456U Δ	Flat Lid	13	6 ea	
10457U Δ	Flat Notched Lid	13	6 ea	
One-Third Size – 12.75" x 7"				
30860 Δ	Pan – 2.5" (2.4 qt)	03, 13	6 ea	
30861 Δ	Pan – 4" (3.8 qt)	03, 13	6 ea	
30862 Δ	Pan – 6" (5.7 qt)	03, 13	6 ea	
30869 Δ	Pan – 8" (7.3 qt)	03, 13	6 ea	
30870 Δ	Drain Shelf	13	6 ea	
EZ Access Lids – One Third Size				
10478Z Δ	EZ Access Lid	13	6 ea	
10479Z Δ	EZ Access Lid Notched	13	6 ea	
10480Z Δ	EZ Access Lid Double Notched	13	6 ea	

Prod No	Description	Color	Pack
Lids – Fits All One-Third Size Pans			
30580	Smart Lid	60	6 ea
10470U Δ	Handled Lid	13	6 ea
10471U Δ	Handled Notched Lid	13	6 ea
10476U Δ	Flat Lid	13	6 ea
10477U Δ	Flat Notched Lid	13	6 ea
One-Quarter Size – 10.25" x 6.38"			
30880 Δ	Pan – 2.5" (1.7 qt)	03, 13	6 ea
30881 Δ	Pan – 4" (2.8 qt)	03, 13	6 ea
30882 Δ	Pan – 6" (4.0 qt)	03, 13	6 ea
30895 Δ	Drain Shelf	13	6 ea
Lids – Fits All One-Quarter Size Pans			
30581	Smart Lid	60	6 ea
10490U Δ	Handled Lid	13	6 ea
10491U Δ	Handled Notched Lid	13	6 ea
10496U Δ	Flat Lid	13	6 ea
10497U Δ	Flat Notched Lid	13	6 ea
One-Sixth Size – 6.75" x 6.38"			
30883 Δ	Pan – 2.5" (1.1 qt)	03, 13	6 ea
30884 Δ	Pan – 4" (1.7 qt)	03, 13	6 ea
30885 Δ	Pan – 6" (2.5 qt)	03, 13	6 ea
30896 Δ	Drain Shelf	13	6 ea
EZ Access Lids – One Half Size			
10518Z Δ	EZ Access Lid	13	6 ea
10519Z Δ	EZ Access Lid Notched	13	6 ea
Lids – Fits All One-Sixth Size Pans			
30582	Smart Lid	60	6 ea
10510U Δ	Handled Lid	13	6 ea
10511U Δ	Handled Notched Lid	13	6 ea
10516U Δ	Flat Lid	13	6 ea
One-Ninth Size – 6.75" x 4.25"			
30886 Δ	Pan – 2.5" (0.7 qt)	03, 13	6 ea
30887 Δ	Pan – 4" (1.0 qt)	03, 13	6 ea
30888 Δ	Pan – 6" (1.4 qt)	03, 13	6 ea
10535 Δ	Drain Shelf	13	6 ea
EZ Access Lids – One Ninth Size			
10538Z Δ	EZ Access Lid	13	6 ea
10539Z Δ	EZ Access Lid Notched	13	6 ea
Lids – Fits All One-Ninth Size Pans			
30583	Smart Lid	60	6 ea
10536U Δ	Flat Lid	13	6 ea
10537U Δ	Flat Notched Lid	13	6 ea

Note: Capacities are based on liquid measurements to rim, i.e. flush fill

NSF Listed products are designated with a Δ and may be prefixed with an N

Made specifically for **warming and holding cabinets**, our single- and double-handled pans help **products stay warm and fresh for your customers.**

Specialty High Heat Handled Pans

- Transports food safely from the oven to the warming unit
- Double handled pan is perfect for restaurants with “pass through” warming units
- Stain-, heat-, and impact- resistant high heat material
- Available in 2.5" and 4" depths
- NSF Listed; dishwasher safe

High Heat Pan Divider

Pair our high heat pan divider (30871) with our 1/3 size, 2.5" deep handled pans (30860HH and 308614) to warm and hold multiple items in one pan while reducing the risk of foods touching; perfect for low volume meat or chicken items

- Use with 1/6 size drain shelf to help keep foods fresh



Amber(13)

Prod No	Description	Color	Pack
Specialty High Heat Pans			
30860H Δ	1/3 Size 2.5" Deep with 1 Handle	13	6 ea
30860HH Δ	1/3 Size 2.5" Deep with 2 Handles	13	6 ea
30861H Δ	1/3 Size 4" Deep with 1 Handle	13	6 ea
30861HH Δ	1/3 Size 4" Deep with 2 Handles	13	6 ea
30871 Δ	1/6 Size 2.5" Deep Pan Divider	13	8 ea

NSF Listed products are designated with a Δ and may be prefixed with an N

NSF Listed products are designated with a Δ and may be prefixed with an N



METAL FOOD PANS & LIDS

Food pans are **the back bone of any foodservice operation**. For storing, preparing, and serving, they are a necessity. Only Carlisle offers you **complete versatility with a broad range of food pans** to meet your needs.

DuraPan™ food pans

Double reinforced corners and unique impact resistant edge design help pans hold shape; will not jam together during storage. Tapered pans fit standard food pan templates and will stack or nest with most other leading brands. Versatile 18-8 stainless pans go from freezer to oven to serving line; ideal for cook-chill operations.

DuraPan Covers

- Made of heavy gauge 18-8 stainless steel
- Available in solid or slotted styles
- Recessed handles offer a secure grip
- Notched lids allow easy access for serving spoons



Steam Table Application

DuraPan's impact resistant edge maintains shape better and lays flat, providing a tight seal for better temperature retention in steam tables



Coldmaster® Application

Use DuraPans with Coldmaster Coldpans (shown on pages 111-113) to keep foods cold without ice or electricity

Full Shoulders
Prevent jamming during storage and provide added strength for longer life

Spoonable Bottoms
Add structural rigidity; allows easy access to food and makes clean up easier



DuraPans Covers, Recessed Handles
Large, recessed handles offer a secure grip. Notched lids allow easy access with serving spoons

Double Reinforced Corners
With unique impact resistant edge design holds shape even under the toughest conditions

Adapter Bars

- Use adapter bars with in steam table applications, Cateraides, or other standard transport containers
- Two sizes available to work with full or fractional size pans



Prod No	Description	Pack
Adapter Bars		
6070A	20.5" Adapter Bar	12 ea
6071A	12.75" Adapter Bar	12 ea



Available in heavy gauge or light gauge, Carlisle offers a wide range of accessories including solid and slotted covers, drain shelves, divided pans, and adapter bars.

Prod No	Description	Pack
Heavy Gauge		
Full-Size – 20.75" x 12.75"		
608002 Δ	Pan – 2.5" (10.4 qt)	6 ea
608004 Δ	Pan – 4" (16.6 qt)	6 ea
608006 Δ	Pan – 6" (24.9 qt)	6 ea
Two-Thirds Size – 13.88" x 12.75"		
608236 Δ	Pan – 6" (16.2 qt)	6 ea
One-Half Size – 12.75" x 10.38"		
608122 Δ	Pan – 2.5" (0.9 qt)	6 ea
608124 Δ	Pan – 4" (1.4 qt)	6 ea
608126 Δ	Pan – 6" (2.1 qt)	6 ea
One-Third Size – 12.75" x 6.88"		
608132 Δ	Pan – 2.5" (3.4 qt)	6 ea
608134 Δ	Pan – 4" (5.4 qt)	6 ea
608136 Δ	Pan – 6" (8.1 qt)	6 ea
One-Quarter Size – 10.38" x 6.38"		
608142 Δ	Pan – 2.5" (2.6 qt)	6 ea
608144 Δ	Pan – 4" (4.2 qt)	6 ea
608146 Δ	Pan – 6" (6.2 qt)	6 ea
One-Sixth Size – 6.88" x 6.25"		
608162 Δ	Pan – 2.5" (1.6 qt)	6 ea
608164 Δ	Pan – 4" (2.6 qt)	6 ea
608166 Δ	Pan – 6" (3.9 qt)	6 ea
One-Ninth Size – 6.88" x 4.25"		
608192 Δ	Pan – 2.5" (1.0 qt)	6 ea
608194 Δ	Pan – 4" (1.7 qt)	6 ea

Prod No	Description	Pack
Light Gauge		
Full-Size – 20.75" x 12.75"		
607001 Δ	Pan – 1" (4.2 qt)	6 ea
607002 Δ	Pan – 2.5" (10.4 qt)	6 ea
607004 Δ	Pan – 4" (16.6 qt)	6 ea
607006 Δ	Pan – 6" (24.9 qt)	6 ea
607002P Δ	Perforated Pan – 2.5"	6 ea
607004P Δ	Perforated Pan – 4"	6 ea
607006P Δ	Perforated Pan – 6"	6 ea
607000C Δ	Solid Cover	6 ea
607000CS	Slotted Cover	6 ea
607000H	Hinged Flat Cover with Handles	6 ea
Two-Thirds Size – 13.88" x 12.75"		
607232 Δ	Pan – 2.5" (6.8 qt)	6 ea
607236 Δ	Pan – 6" (16.2 qt)	6 ea
607230C Δ	Solid Cover	6 ea
One-Half Size – 12.75" x 10.38"		
607122 Δ	Pan – 2.5" (0.9 qt)	6 ea
607124 Δ	Pan – 4" (1.4 qt)	6 ea
607126 Δ	Pan – 6" (2.1 qt)	6 ea
607122P Δ	Perforated Pan – 2.5"	6 ea
607124P Δ	Perforated Pan – 4"	6 ea
607120C Δ	Solid Cover	6 ea
607120CS	Slotted Cover	6 ea
One-Half Long Size – 20.5" x 6.38"		
60700HL2 Δ	Pan – 2.5" (5.2 qt)	6 ea
60700HL4 Δ	Pan – 4" (8.3 qt)	6 ea
60700HL6 Δ	Pan – 6" (12.5 qt)	6 ea
60700HLC Δ	Solid Cover	6 ea
One-Third Size – 12.75" x 6.88"		
607132 Δ	Pan – 2.5" (3.4 qt)	6 ea
607134 Δ	Pan – 4" (5.4 qt)	6 ea
607136 Δ	Pan – 6" (8.1 qt)	6 ea
607130C Δ	Solid Cover	6 ea
607130CS	Slotted Cover	6 ea
One-Quarter Size – 10.38" x 6.38"		
607142 Δ	Pan – 2.5" (2.6 qt)	6 ea
607144 Δ	Pan – 4" (4.2 qt)	6 ea
607146 Δ	Pan – 6" (6.2 qt)	6 ea
607140C Δ	Solid Cover	6 ea
607140CS	Slotted Cover	6 ea
One-Sixth Size – 6.88" x 6.25"		
607162 Δ	Pan – 2.5" (1.6 qt)	6 ea
607164 Δ	Pan – 4" (2.6 qt)	6 ea
607166 Δ	Pan – 6" (3.9 qt)	6 ea
607160C Δ	Solid Cover	6 ea
607160CS	Slotted Cover	6 ea
One-Ninth Size – 6.88" x 4.25"		
607192 Δ	Pan – 2.5" (1.0 qt)	6 ea
607194 Δ	Pan – 4" (1.7 qt)	6 ea
607190C Δ	Solid Cover	6 ea
607190CS	Slotted Cover	6 ea

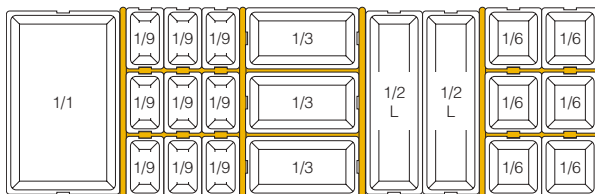
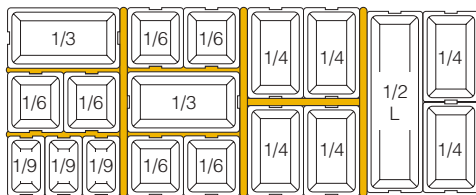

Note: Capacities are based on liquid measurements to rim, i.e. flush fill

NSF Listed products are designated with a Δ and may be prefixed with an N



STORPLUS™ STORAGE BOXES

StorPlus **color-coded** storage boxes are a solution that helps employees **easily identify** proper storage containers, **eliminating cross-contamination**.

Benefits of StorPlus Color-Coded Storage Boxes

- Prevent cross-contamination and help meet standards as part of a complete HACCP Program
- RimGlow™ technology gives the boxes and lids a distinct, yet transparent color to segregate them by usage

StorPlus Color-Coded Storage Boxes & Lids

Food Storage Boxes

- Reinforced top and bottom corners on both box and lid, help prevent chipping and cracking
- Quart, gallon, and liter capacity indicators (on 12" x 18" box)
- StorPlus boxes stack easily for efficient storage, fit standard carts and racks, and with other boxes on the market
- Smooth interior surface makes cleaning easy
- "Lock-Tight" lids can be reversed and used as bun pan or tray
- Polycarbonate boxes provide easy visibility, superior resistance to food acids and oils, and withstands temperatures from -40°F to 212°F
- Boxes double as dough proofing bus boxes, warewashing tubs for kitchen overflow, or remote locations
- 18" x 26" colander is ideal for storing, draining, thawing, and marinating foods; keeps lettuce crisp, thaws and drains fish on ice, marinates chicken, etc.
- Polyethylene boxes offers economical storage and transport and withstands temperatures from -40°F to 180°F
- NSF Listed; dishwasher safe

ServSafe® Recommended Stacking Order:



Allergen Control

Cooked/Dry Foods & Dairy

Fruits/Vegetables

Meats

Fish/Seafood

Poultry



ServSafe® is a registered trademark of the National Restaurant Association

White(02)	Red(05)	Clear(07)	Green(09)	Blue(14)	Yellow(22)	Purple(89)
Prod No	Color	Prod No	Color	Description	Pack	
Clear Polycarbonate*		Color-Coded Polycarbonate				
10610 Δ	07			2 gal 12" x 18" x 3.5 Box	6 ea	
10611 Δ	07	10611C Δ	05, 09, 14, 22	3.5 gal 12" x 18" x 6" Box	6 ea	
10612 Δ	07	10612C Δ	05, 09, 14, 22	5 gal 12" x 18" x 9" Box	6 ea	
10617 Δ	07	10617C Δ	05, 09, 14, 22	12" x 18" Lid	6 ea	
10620 Δ	07	—		5 gal 18" x 26" x 3.5" Box	6 ea	
10621 Δ	07	10621C Δ	05, 09, 14, 22, 89	8.5 gal 18" x 26" x 6" Box	6 ea	
10622 Δ	07	10622C Δ	05, 09, 14, 22, 89	12.5 gal 18" x 26" x 9" Box	4 ea	
10623 Δ	07	10623C Δ	05, 09, 14, 22	16.6 gal 18" x 26" x 12" Box	3 ea	
10624 Δ	07	10624C Δ	05, 09, 14, 22	21.5 gal 18" x 26" x 15" Box	3 ea	
10627 Δ	07	10627C Δ	05, 09, 14, 22, 89	18" x 26" Lid	6 ea	
10628 Δ	07	—		18" x 26" x 5" Colander	6 ea	
10629 Δ	07	—		18" x 26" Drain Grate	6 ea	

NSF Listed products are designated with a Δ and may be prefixed with an N

*Clear polycarbonate food boxes comes in Clear(07) only



White(02)

Prod No	Description	Color	Pack
White Polyethylene			
10630 Δ	2 gal 12" x 18" x 3.5" Box	02	6 ea
10631 Δ	3.5 gal 12" x 18" x 6" Box	02	6 ea
10632 Δ	5 gal 12" x 18" x 9" Box	02	6 ea
10637 Δ	12" x 18" "Lock-Tight" Lid	02	6 ea
10640 Δ	5 gal 18" x 26" x 3.5" Box	02	6 ea
10641 Δ	8.5 gal 18" x 26" x 6" Box	02	6 ea
10642 Δ	12.5 gal 18" x 26" x 9" Box	02	4 ea
10643 Δ	16.6 gal 18" x 26" x 12" Box	02	3 ea
10644 Δ	21.5 gal 18" x 26" x 15" Box	02	3 ea
10647 Δ	18" x 26" "Lock-Tight" Lid	02	6 ea
10648 Δ	18" x 26" x 5" Colander	02	6 ea

NSF Listed products are designated with a Δ and may be prefixed with an N



STORPLUS™ STORAGE CONTAINERS

StorPlus storage containers are clear and have **tight fitting lids**, improving organization and **minimizing the risk** of cross contamination, **making work easier**.

Square Food Storage Containers

- Perfect for storing condiments, spices, toppings, leftover, or preparation
- Clear polycarbonate containers provide exceptional durability and can withstand temperatures from -40°F to 212°F
- Economical white polyethylene containers withstand temperatures from -40°F to 180°F
- Stackable with other popular brands
- Color-coded, textured snap-on lids fit both the polycarbonate and polyethylene containers
- Smooth interior finish makes clean up easy
- NSF Listed; dishwasher safe



Safe & Easy Lifting
Only Carlisle offers square storage containers in 1qt-8qt with handles on both sides

Cross Compatible
Carlisle StorPlus lids fit key competitors' food storage containers



Prod No	Description	Color	Pack
StorPlus Square Polycarbonate Food Storage Containers			
10720 Δ	2 qt, 7.13" Sq x 3.81" H Polycarbonate Container	07, AF07	6 ea
10721 Δ	4 qt, 7.13" Sq x 7.31" H Polycarbonate Container	07, AF07	6 ea
10722 Δ	6 qt, 8.75" Sq x 7.31" H Polycarbonate Container	07, AF07	6 ea
10723 Δ	8 qt, 8.75" Sq x 9" H Polycarbonate Container	07, AF07	6 ea
10724 Δ	12 qt, 11.13" Sq x 8.25" H Polycarbonate Container	07, AF07	6 ea
10725 Δ	18 qt, 11.13" Sq x 12.56" H Polycarbonate Container	07, AF07	6 ea
10726 Δ	22 qt, 11.13" Sq x 15.75" H Polycarbonate Container	07, AF07	6 ea
StorPlus Square Polyethylene Food Storage Containers			
10730 Δ	2 qt, 7.13" Sq x 3.81" H Polyethylene Container	02	6 ea
10731 Δ	4 qt, 7.13" Sq x 7.31" H Polyethylene Container	02	6 ea
10732 Δ	6 qt, 8.75" Sq x 7.31" H Polyethylene Container	02	6 ea
10733 Δ	8 qt, 8.75" Sq x 9" H Polyethylene Container	02	6 ea
10734 Δ	12 qt, 11.13" Sq x 8.25" H Polyethylene Container	02	6 ea
10735 Δ	18 qt, 11.13" Sq x 12.56" H Polyethylene Container	02	6 ea
10736 Δ	22 qt, 11.13" Sq x 15.75" H Polyethylene Container	02	6 ea
StorPlus Square Container Lids			
10740 Δ	2-4 qt, 7.31" Sq Lid	08, 89	6 ea
10741 Δ	6-8 qt, 9" Sq Lid	05, 89	6 ea
10742 Δ	12-18-22 qt, 11.38" Sq Lid	60, 89	6 ea

NSF Listed products are designated with a Δ and may be prefixed with an N

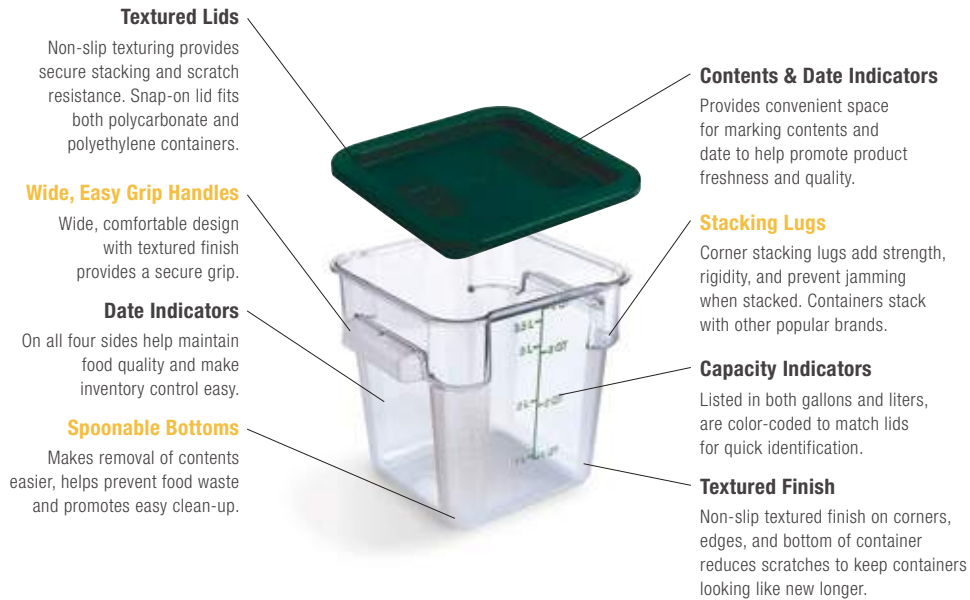

Economical Space Savers

- Clean, safe alternative to storing food in shipping cartons
- Square shape allows for practical storage in the freezer, cooler, or shelf
- Molded-in volume graduations indicate capacity
- Translucent polypropylene offers contact clarity for easy identification of products
- Withstand temperatures from 32°F to 170°F
- Economical white polyethylene withstands temperatures from -40°F to 180°F
- NSF Listed; dishwasher safe



Prod No	Description	Color	Pack
Economical Polypropylene Space Savers			
ST1532 Δ	2 qt, 6.62" Sq x 4.12" H Polypropylene Container	30	12 ea
ST1544 Δ	4 qt, 6.62" Sq x 8.12" H Polypropylene Container	30	12 ea
ST1556 Δ	6 qt, 8.60" Sq x 6.87" H Polypropylene Container	30	12 ea
ST1568 Δ	8 qt, 8.60" Sq x 9.25" H Polypropylene Container	30	12 ea
ST1629 Δ	18 qt, 14.18" x 8.31" x 12.75" H Polypropylene Container	30	6 ea
Economical Polyethylene Space Savers			
1532 Δ	2 qt, 6.62" Sq x 4.12" H Polyethylene Container	02	12 ea
1544 Δ	4 qt, 6.62" Sq x 8.12" H Polyethylene Container	02	12 ea
1556 Δ	6 qt, 8.60" Sq x 8.12" H Polyethylene Container	02	12 ea
1568 Δ	8 qt, 8.60" Sq x 9.25" H Polyethylene Container	02	12 ea
1629 Δ	18 qt, 14.18" x 8.31" x 12.75" H Polyethylene Container	02	6 ea
Economical Space Saver Lids			
ST1573	2-4 qt, 6.62" Sq Lid	30	12 ea
ST1587	6-8 qt, 8.60" Sq Lid	30	12 ea
ST1630	18 qt, 14.37" Sq Lid	30	6 ea

NSF Listed products are designated with a Δ and may be prefixed with an N



STORPLUS™ STORAGE CONTAINERS

Round Food Storage Containers

- Super-tough, clear polycarbonate for ultimate durability allows easy food content identification at a glance
- StorPlus containers stack with other major brands for convenient storage; stacking shoulder prevents jamming
- Date indicator helps maintain food quality and control inventory turns, interchangeable with other brands
- Exclusive Carlisle spoonable bottom for increased yield and less food waste
- Clear polycarbonate containers can withstand temperatures from -40°F to 212°F
- NSF Listed; dishwasher safe



Prod No	Description	Color	Pack
StorPlus Round Food Storage Containers			
10761 Δ	1 qt Round Container	07	12 ea
10763 Δ	2 qt Round Container	07	12 ea
10764 Δ	4 qt Round Container	07	12 ea
10765 Δ	6 qt Round Container	07	12 ea
10766 Δ	8 qt Round Container	07	12 ea
10767 Δ	12 qt Round Container	07	6 ea
10768 Δ	18 qt Round Container	07	6 ea
10769 Δ	22 qt Round Container	07	6 ea
StorPlus Round Container Lids			
10770 Δ	1 qt Round Lid	30	12 ea
10771 Δ	2-4 qt Round Lid	08	12 ea
10772 Δ	6-8 qt Round Lid	05	12 ea
10773 Δ	12-18-22 qt Round Lid	60	6 ea

NSF Listed products are designated with a Δ and may be prefixed with an N



Bains Maries

- Carlisle Bains Marie are the original round food storage containers
- Outside stacking lugs prevent jamming
- 12, 18, & 22 qt sizes have recessed handles for extra strength and stability in lifting, as well as graduated U.S. measurements shown on the side of the container
- 2, 3.5, 6, & 8 qt sizes can be imprinted
- Clear polypropylene containers are translucent and seamless, offering contact clarity for easy identification of products
- Polypropylene containers withstand temperatures from 32°F to 170°F
- Economical white polyethylene containers will withstand temperatures from -40°F to 180°F
- NSF Listed; dishwasher safe



Prod No	Description	Color	Pack
Bains Marie Polypropylene Containers			
0205 Δ	2 qt Container, 6.56" D x 4.38" H	30	12 ea
0355 Δ	3.5 qt Container, 6.56" D x 7.63" H	30	12 ea
0605 Δ	6 qt Container, 7.63" D x 8.13" H	30	12 ea
0805 Δ	8 qt Container, 7.63" D x 10.75" H	30	12 ea
1205 Δ	12 qt Container, 12.25" D x 8.75" H	30	6 ea
1805 Δ	18 qt Container, 12.38" D x 13" H	30	6 ea
2205 Δ	22 qt Container, 12.25" D x 15.44" H	30	6 ea
Bains Marie Polypropylene Container Lids			
0202 Δ	2 – 3.5 qt Lid, 6.69" D x .31" H	30	12 ea
0602 Δ	6 – 8 qt Lid, 8.06" D x .38" H	30	12 ea
1252 Δ	12 – 18 – 22 qt Lid, 12.38" D x .75" H	30	6 ea
Bains Marie Polyethylene Containers			
0200 Δ	2 qt Container, 6.56" D x 4.44" H	02	12 ea
0350 Δ	3.5 qt Container, 6.56" D x 7.63" H	02	12 ea
0600 Δ	6 qt Container, 7.63" D x 8.13" H	02	12 ea
0800 Δ	8 qt Container, 7.625" D x 10.75" H	02	12 ea
1200 Δ	12 qt Container, 12.25" D x 8.75" H	02	6 ea
1800 Δ	18 qt Container, 12.38" D x 13" H	02	6 ea
2200 Δ	22 qt Container, 12.25" D x 15.44" H	02	6 ea
Bains Marie Polyethylene Container Lids			
0203 Δ	2 – 3.5 qt Lid, 6.69" D	02	12 ea
0603 Δ	6 – 8 qt Lid, 8.63" D	02	12 ea
1202 Δ	12 – 18 – 22 qt Lid, 12.38" D	02	6 ea

NSF Listed products are designated with a Δ and may be prefixed with an N



FOOD PAN ACCESSORIES

Divided DuraPans

- Divided pan is perfect for serving complimentary foods
- Single pan fits in full size pan opening; eliminates the need for adapter bars



Divided Pan with PC140N Cateraide™ Top Loader



Drain Grates

- Chrome-plated, heavy-duty grates with durable welded construction holds food above pan
- Use for cooling or draining foods
- Fits full size pans

Prod No	Description	Pack
Divided DuraPans		
607002D Δ	Full-Size Divided Pan 2.5" Deep	6 ea
Drain Grates		
602202	Drain Grate - Fits Full-Size Food Pan	6 ea
602203	Drain Grate - Fits Half-Size Food Pan	6 ea

NSF Listed products are designated with a Δ and may be prefixed with an N



Ingredient Bins

- Portable, convenient storage bins for large quantities of sugar, flour, etc.
- Lids slide open for easy access
- Heavy-duty, non-marking casters
- Replacement Parts for BIN27, BIN36, & BIN44 shown in chart below



Floor Rack System

- Interlocking modular system provides a raised surface in dry and cooling storage areas
- Perfect for areas where moisture collects on the floor
- Open design allows for air circulation
- 12" square units lock together, holds up to 3,000 pounds per square foot
- Made of FDA approved high density polyethylene, withstands temperatures from -40°F to 180°F
- NSF Listed; dishwasher safe or clean with hose



Prod No	Description	Color	Pack
Ingredient Bins			
BIN27	27 gal Capacity Bin, 28.5"L x 12.69"W x 27.88"H	02	1 ea
BIN36	36 gal Capacity Bin, 29.5"L x 15.38"W x 28.25"H	02	1 ea
BIN44	44 gal Capacity Bin, 29.5"L x 18.13"W x 29"H	02	1 ea
BIN27L	Replacement lid for BIN27	02	1 ea
BIN36L	Replacement lid for BIN36	02	1 ea
BIN44L	Replacement lid for BIN44	02	1 ea
Floor Rack			
2710 Δ	12" x 12" x 1.5" Floor Rack	23	12 ea

NSF Listed products are designated with a Δ and may be prefixed with an N



CARLISLE
FOODSERVICE PRODUCTS

EFFICIENT
DURABLE
INNOVATIVE
SMART
**WARE-
WASHING
PRODUCTS**

Carlisle offers every rack, basket, and accessory you need for efficient warewashing operations. OptiClean™ is the industry standard for enabling clean, spotless ware. Our full line of color-coded rack extenders and Plaque-a-Rack are the ideal solution for sorting and managing your ware.





OPTICLEAN™

Engineered to Flow

Warewashing can be labor intensive. If not well managed, it is likely to hurt your operation's bottom line and add unnecessary frustration. However, labor and efficiency is not the operator's only problem. The quality of your warewashing could directly effects your customers' health and the reputation of your establishment. If an effective system of cleaning and sanitation is not upheld, you may be facing risks on a daily basis that could jeopardize the future of your business.



3-Component System

Base Rack // Open Extender // Divided Extender

By alternating open and divided extenders, each level of the rack offers heavy flow through of water for performance and thick divided walls for protection



Double-wall Construction

Maximum strength, protects contents from moving machine parts



Versatile Stacking

Stacking from either direction and with all major competitors



Open Wall Design

Open profile facilitates superior washing, complete rinsing, and fast drying



Quick Draining

No flat surfaces to trap water or loose food particles within the rack—ensuring rapid drying



4-way Tracking

Easy dish machine loading from any side without the need to rotate racks



Locking Extenders

Unique snap-on design allows for fast, simple assembly



Comfort Curve Handles

Comfort Curve Handles—molded into all four sides for easy handling, won't pinch fingers

All OptiClean Racks have an outside measurement of 19.75" x 19.75"

The Honeycomb

We've developed the most highly engineered warewashing solutions to improve your establishment's operational efficiency. Carlisle utilizes a tested geometric honeycomb structure, admired and studied since ancient times. The honeycomb design delivers unmatched durability while simultaneously increasing the flow of water through each rack. The open honeycomb design also eliminates flat surfaces and corners that would otherwise harbor food particles allowing water to drain and contents to dry quickly.

NeWave™

In pursuit of an even more efficient foodservice operation, we developed the OptiClean NeWave glass rack. These rounded wave design racks hold 20% more glasses than equivalent, square-compartment racks. This means more glasses in less racks, reduced chemical and/or water usage and improved labor efficiency. NeWave also holds glasses securely in place, resulting in minimal movement and reduced breakage.

Easy Identification

Water is not the only aspect we engineered to flow. A color-coded system allows operators to choose their own method of identification to categorize by the type of glass, location of wares within the facility, or even specific types of events. This color-coded system allows your operation to flow smoothly and eliminate unnecessary confusion for both existing and new employees.



Textured Finish

Non-slip textured finish on outside walls reduces scratches to keep racks looking new, improve durability, and provide a secure grip



6 Extender Colors



NSF Listed

How To Create The Correct Item Number For Your Washrack

1 Each item begins with an **R** for rack

2 Second digit indicates type

G // Glass
W // NeWave
C // Cup
P // Peg/Plate*
B // Bowl*
F // Flatware*
SP // Sheet Pan*
FP // Food Pan*
PC // Plate Cover*
TP // Tall Peg*
OP // Open Peg*

*Skip to Step Six

Only available in Blue (14)

3 Glass, NeWave (only 20 or 30) & Cup (only 16 or 20) racks have additional digits beginning with number of compartments

9 // Nine Compartment
 16 // Sixteen Compartment
 20 // Twenty Compartment
25 // Twenty-five Compartment
 30 // Thirty Compartment
 36 // Thirty-six Compartment
 49 // Forty-nine Compartment

4 To add extenders, add a dash and the # of extenders

-1 // One Extender
 -2 // Two Extenders
-3 // Three Extenders
 -4 // Four Extenders
 -5 // Five Extenders

5 If you want color-coded extenders, add a **C** – Otherwise, skip this step

6 Lastly, add the color-code

410 // Red/Blue
 411 // Yellow/Blue
 412 // Orange/Blue
 413 // Green/Blue
 414 // Lavender/Blue
 14 // Blue

7 This order is for a glass rack with 25 compartments, 3 extenders and the top extender is red.

RG25-3C410

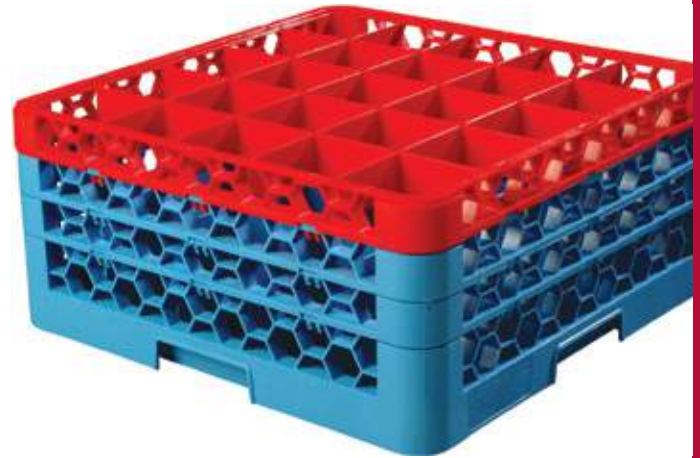

Extender Heights

No Extender	3-1/4"
1 Extender	5"
2 Extenders	6-3/4"
3 Extenders	8-1/2"
4 Extenders	10-1/4"
5 Extenders	12"

- Extenders are available in multiple colors including Blue (14), Yellow (04), Red (05), Green (09), Orange (24), Lavender (89)
- Additional accessories can be found by clicking the catalog link below

Washrack Sizing

Rack #	Description	Min Dia	Max Dia	Min Dia	Max Dia	Dia for Handles
Standard						
RG49	49 Compartment Glass Rack	2"	2-3/8"	51 mm	60 mm	2-7/8"
RG36	36 Compartment Glass Rack	2-3/8"	2-3/4"	60 mm	70 mm	3-5/8"
RG25	25 Compartment Glass Rack	2-3/4"	3-3/8"	70 mm	86 mm	4-3/8"
RG16	16 Compartment Glass Rack	3-3/8"	4-3/8"	86 mm	111 mm	5-5/8"
RG9	9 Compartment Glass Rack	4-3/8"	5-7/8"	111 mm	149 mm	7-3/4"
NeWave						
RW30	Glass Rack w/ Integrated Extender 30 Compartment	2-5/8"	3"	67 mm	76 mm	
RW20	Glass Rack w/ Integrated Extender 20 Compartment	3"	3-3/4"	76 mm	95 mm	
Tilted Cup						
RC20	Tilted Cup Rack 20 Compartment	2-5/8"	4-1/4"	67 mm	108 mm	5-1/8"
RC16	Tilted Cup Rack 16 Compartment	4-1/4"	4-3/8"	108 mm	111 mm	6-5/8"

www.carlislefsp.com/FINDRACK



OPTICLEAN®

Color-Coded Glass Racks

- OptiClean Glass Racks with Color-Coded Extenders make it easy to identify glass rack size or match specific glassware with a specific rack simply by color
- Carlisle's OptiClean system includes a full range of glass racks designed to meet your needs
- Full dividers in the base offer complete protection for delicate rims
- NSF Listed



Available Colors & Combinations

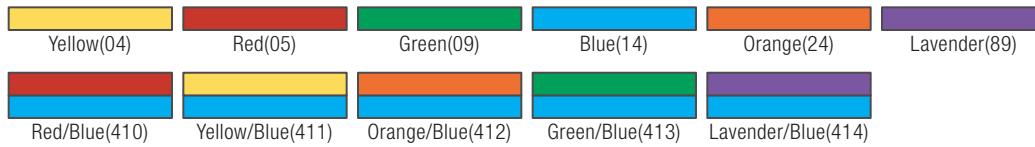

New Color-Coded Options

Engineered to Flow

If your operation has multiple drinkware styles that need to be washed, stored, and easily identified, Carlisle has a solution to make work easier. Our OptiClean extenders are now available in six color choices. Use this option to color-code your glass racks and keep each piece of drinkware in its proper place. If you have multiple areas of serving within your establishment you can designate specific colors so that your fine dining stemware stays separate from the poolside drinkware.



OptiClean NeWave Color-Coded Glass Racks

- Same features as our OptiClean Glass Racks with an added practical interior design that holds 20% more glasses than comparable square racks
- NeWave Glass Racks are a green choice as they help to lower your chemical usage and labor costs
- Rounded design holds glasses securely in place, resulting in less movement and breakage
- NeWave offers two compartment sizes designed to fit the most popular sizes of glassware and tumblers
- NSF Listed



NeWave 20-Compartment

- Use for glasses & tumblers

NeWave 30-Compartment

- Use for glasses & tumblers



RW20-1



RW30-2

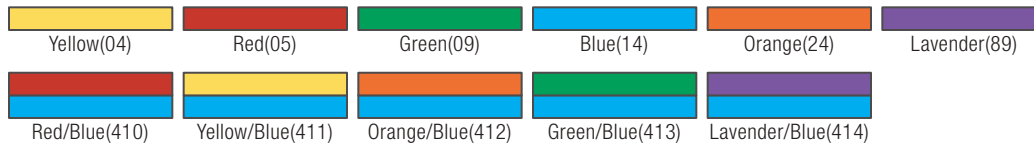

Prod No	Description	Glass Dia*	Glass Height	Color	Pack
20-Compartment NeWave Glass Rack - Compartment Size 3.81" Dia					
RW20 Δ	20-Compartment with Integrated Extender	3.56"	4.75"	14	4 ea
RW20-1 Δ	20-Compartment with 2 Extenders	3.56"	6.34"	14	3 ea
RW20-2 Δ	20-Compartment with 3 Extenders	3.56"	7.94"	14	2 ea
RW20-3 Δ	20-Compartment with 4 Extenders	3.56"	9.5"	14	2 ea
REW20S	20-Compartment Extender	3.56"	1.5"	14	6 ea
20-Compartment Color-Coded NeWave Glass Rack—Compartment Size 3.81" Dia					
REW20SC	20-Compartment Divided Extender	3.56"	1.5"	04, 05, 09, 24, 89	6 ea
RW20-C Δ	20-Compartment with Integrated Extender	3.56"	4.75"	410, 411, 412, 413, 414	4 ea
RW20-1C Δ	20-Compartment with 2 Extenders	3.56"	6.34"	410, 411, 412, 413, 414	3 ea
RW20-2C Δ	20-Compartment with 3 Extenders	3.56"	7.94"	410, 411, 412, 413, 414	2 ea
RW20-3C Δ	20-Compartment with 4 Extenders	3.56"	9.5"	410, 411, 412, 413, 414	2 ea
RW20-4C Δ	20-Compartment with 5 Extenders	3.56"	11.1"	410, 411, 412, 413, 414	1 ea
30-Compartment NeWave Glass Rack - Compartment Size 3.13" Dia					
RW30 Δ	30-Compartment with Integrated Extender	2.88"	4.75"	14	4 ea
RW30-1 Δ	30-Compartment with 2 Extenders	2.88"	6.34"	14	3 ea
RW30-2 Δ	30-Compartment with 3 Extenders	2.88"	7.94"	14	2 ea
RW30-3 Δ	30-Compartment with 4 Extenders	2.88"	9.5"	14	2 ea
REW30S	30-Compartment Extender	2.88"	1.5"	14	6 ea
30-Compartment Color-Coded NeWave Glass Rack—Compartment Size 3.13" Dia					
REW30SC	30-Compartment Divided Extender	3.56"	1.5"	04, 05, 09, 24, 89	6 ea
RW30-C Δ	30-Compartment with Integrated Extender	2.88"	4.75"	410, 411, 412, 413, 414	4 ea
RW30-1C Δ	30-Compartment with 2 Extenders	2.88"	6.34"	410, 411, 412, 413, 414	3 ea
RW30-2C Δ	30-Compartment with 3 Extenders	2.88"	7.94"	410, 411, 412, 413, 414	2 ea
RW30-3C Δ	30-Compartment with 4 Extenders	2.88"	9.5"	410, 411, 412, 413, 414	2 ea
RW30-4C Δ	30-Compartment with 5 Extenders	2.88"	11.1"	410, 411, 412, 413, 414	1 ea

NSF Listed products are designated with a Δ and may be prefixed with an N
 *Dimensions shown are for the recommended maximum glass size for the compartment



OPTICLEAN®

9-Compartment

- Use with large brandy snifters, grande margaritas, carafes, and other items with a wide diameter



RG9-1

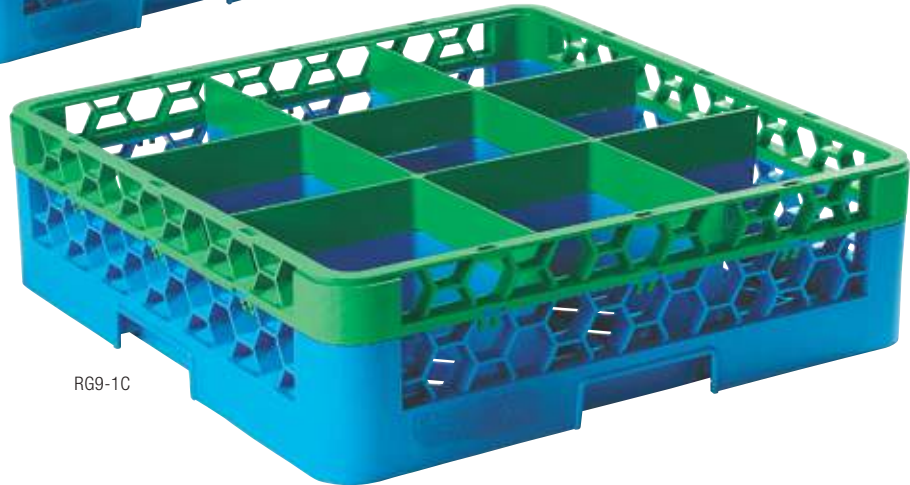

RG9-1C

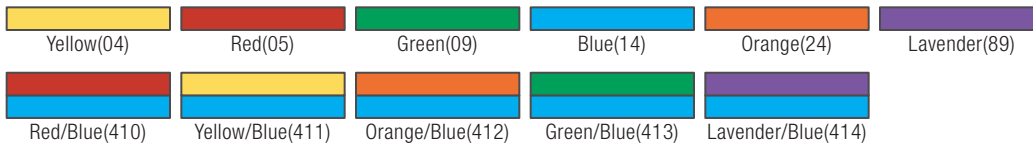

Prod No	Description	Glass Dia**	Glass Height	Color	Pack
9-Compartment Glass Rack—Compartment Size 5.81" Square					
RG9 Δ	9-Compartment	5.56"	3.19"	14	6 ea
RG9-1 Δ	9-Compartment with 1 Extender	5.56"	4.75"	14	4 ea
RG9-2 Δ	9-Compartment with 2 Extenders	5.56"	6.34"	14	3 ea
RG9-3 Δ	9-Compartment with 3 Extenders	5.56"	7.94"	14	2 ea
RG9-4 Δ	9-Compartment with 4 Extenders	5.56"	9.5"	14	2 ea
RG9-5 Δ	9-Compartment with 5 Extenders	5.56"	11.1"	14	2 ea
RE9	9-Compartment Divided Extender	5.56"	9.5"	14	6 ea
RE*	Open Extender	—	1.5"	14	6 ea
9-Compartment Color-Coded Glass Rack—Compartment Size 5.81" Square					
RG9-1C Δ	9-Compartment with 1 Extender	5.56"	4.75"	410, 411, 412, 413, 414	4 ea
RG9-2C Δ	9-Compartment with 2 Extenders	5.56"	6.34"	410, 411, 412, 413, 414	3 ea
RG9-3C Δ	9-Compartment with 3 Extenders	5.56"	7.94"	410, 411, 412, 413, 414	2 ea
RG9-4C Δ	9-Compartment with 4 Extenders	5.56"	9.5"	410, 411, 412, 413, 414	2 ea
RG9-5C Δ	9-Compartment with 5 Extenders	5.56"	11.1"	410, 411, 412, 413, 414	2 ea
RE9C	9-Compartment Divided Extender	5.56"	1.5"	04, 05, 09, 24, 89	6 ea
RE*	Open Extender	—	1.5"	14	6 ea

NSF Listed products are designated with a Δ and may be prefixed with an N

* Note: The RE Open Extender can be used with any OptiClean Glass or Dish Rack

**Dimensions shown are for the recommended maximum glass size for the compartment

16-Compartment

- Perfect for large cocktail glasses and delicate wine stems with oversize bowls



RG16-1



RG16-2C

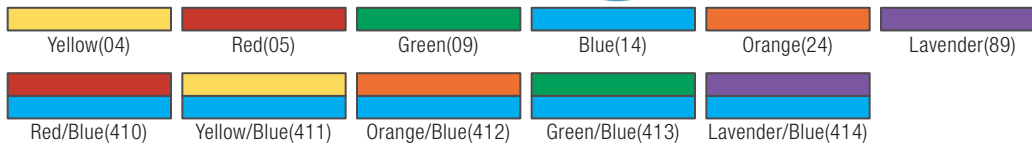

Prod No Description Glass Dia Glass Height Color Pack**

16-Compartment OptiClean Glass Rack—Compartment Size 4.44" Square

RG16 Δ	16-Compartment	4.19"	3.19"	14	6 ea
RG16-1 Δ	16-Compartment with 1 Extender	4.19"	4.75"	14	4 ea
RG16-2 Δ	16-Compartment with 2 Extenders	4.19"	6.34"	14	3 ea
RG16-3 Δ	16-Compartment with 3 Extenders	4.19"	7.94"	14	2 ea
RG16-4 Δ	16-Compartment with 4 Extenders	4.19"	9.5"	14	2 ea
RG16-5 Δ	16-Compartment with 5 Extenders	4.19"	11.1"	14	2 ea
RE16	16-Compt Divided Extender	4.19"	1.5"	14	6 ea
RE*	Open Extender	—	1.5"	14	6 ea

16-Compartment OptiClean Color-Coded Glass Rack—Compartment Size 4.44" Square

RG16-1C Δ	16-Compartment with 1 Extender	4.19"	4.75"	410, 411, 412, 413, 414	4 ea
RG16-2C Δ	16-Compartment with 2 Extenders	4.19"	6.34"	410, 411, 412, 413, 414	3 ea
RG16-3C Δ	16-Compartment with 3 Extenders	4.19"	7.94"	410, 411, 412, 413, 414	2 ea
RG16-4C Δ	16-Compartment with 4 Extenders	4.19"	9.5"	410, 411, 412, 413, 414	2 ea
RG16-5C Δ	16-Compartment with 5 Extenders	4.19"	11.1"	410, 411, 412, 413, 414	2 ea
RE16C	16-Compartment Divided Extender	4.19"	1.5"	04, 05, 09, 24, 89	6 ea
RE*	Open Extender	—	1.5"	14	6 ea

NSF Listed products are designated with a Δ and may be prefixed with an N

* Note: The RE Open Extender can be used with any OptiClean Glass or Dish Rack

**Dimensions shown are for the recommended maximum glass size for the compartment



OPTICLEAN®

25-Compartment

- Use for large diameter beverage glasses, red wine stems, goblets, and most rocks glasses



RG25-1

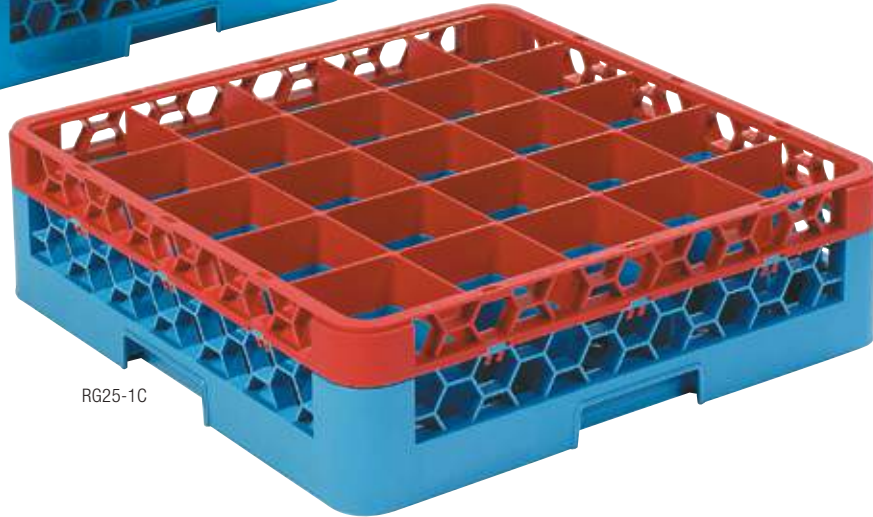

RG25-1C

www.carlislefsp.com/FINDRACK

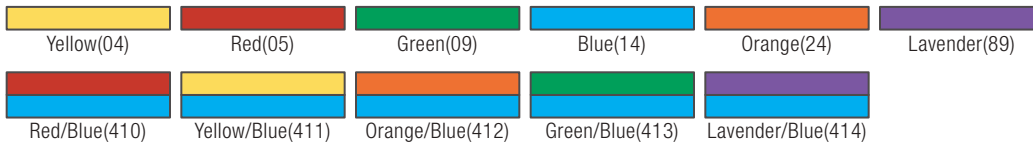

Prod No	Description	Glass Dia**	Glass Height	Color	Pack
---------	-------------	-------------	--------------	-------	------

25-Compartment OptiClean Glass Rack—Compartment Size 3.5" Square

RG25 Δ	25-Compartment	3.25"	3.19"	14	6 ea
RG25-1 Δ	25-Compartment with 1 Extender	3.25"	4.75"	14	4 ea
RG25-2 Δ	25-Compartment with 2 Extenders	3.25"	6.34"	14	3 ea
RG25-3 Δ	25-Compartment with 3 Extenders	3.25"	7.94"	14	2 ea
RG25-4 Δ	25-Compartment with 4 Extenders	3.25"	9.5"	14	2 ea
RG25-5 Δ	25-Compartment with 5 Extenders	3.25"	11.1"	14	2 ea
RE25	25-Compartment Divided Extender	3.25"	1.5"	14	6 ea
RE*	Open Extender	—	1.5"	14	6 ea

25-Compartment OptiClean Color-Coded Glass Rack—Compartment Size 3.5" Square

RG25-1C Δ	25-Compartment with 1 Extender	3.25"	4.75"	410, 411, 412, 413, 414	4 ea
RG25-2C Δ	25-Compartment with 2 Extenders	3.25"	6.34"	410, 411, 412, 413, 414	3 ea
RG25-3C Δ	25-Compartment with 3 Extenders	3.25"	7.94"	410, 411, 412, 413, 414	2 ea
RG25-4C Δ	25-Compartment with 4 Extenders	3.25"	9.5"	410, 411, 412, 413, 414	2 ea
RG25-5C Δ	25-Compartment with 5 Extenders	3.25"	11.1"	410, 411, 412, 413, 414	2 ea
RE25C	25-Compartment Divided Extender	3.25"	1.5"	04, 05, 09, 24, 89	6 ea
RE*	Open Extender	—	1.5"	14	6 ea

NSF Listed products are designated with a Δ and may be prefixed with an N

* Note: The RE Open Extender can be used with any OptiClean Glass or Dish Rack

**Dimensions shown are for the recommended maximum glass size for the compartment

36-Compartment

- Use with tumblers, white wine glasses, and other narrow bowl stems

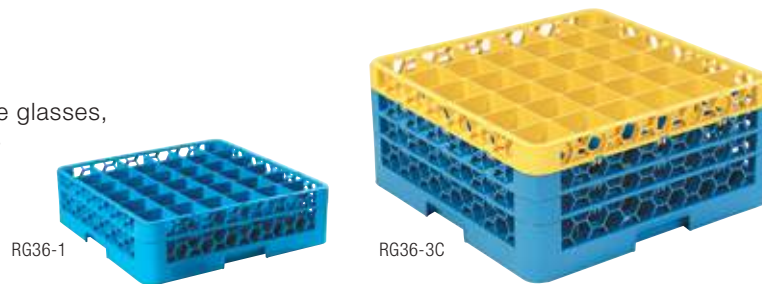

Prod No	Description	Glass Dia**	Glass Height	Color	Pack	Cs Wt/Cube
36-Compartment OptiClean Glass Rack—Compartment Size 2.94" Square						
RG36 Δ	36-Compartment	2.69"	3.19"	14	6 ea	35.55/5.99
RG36-1 Δ	36-Compartment with 1 Extender	2.69"	4.75"	14	4 ea	31.80/5.58
RG36-2 Δ	36-Compartment with 2 Extenders	2.69"	6.34"	14	3 ea	27.10/5.46
RG36-3 Δ	36-Compartment with 3 Extenders	2.69"	7.94"	14	2 ea	22.70/4.45
RG36-4 Δ	36-Compartment with 4 Extenders	2.69"	9.5"	14	2 ea	26.00/5.30
RG36-5 Δ	36-Compartment with 5 Extenders	2.69"	11.1"	14	2 ea	28.10/6.12
RE36	36-Compartment Divided Extender	2.69"	1.5"	14	6 ea	13.35/2.77
RE*	Open Extender/Hgt: 1.5"	—	1.5"	14	6 ea	7.75/2.77
36-Compartment OptiClean Color-Coded Glass Rack—Compartment Size 2.94" Square						
RG36-1C Δ	36-Compartment with 1 Extender	2.69"	4.75"	410, 411, 412, 413, 414	4 ea	31.80/5.58
RG36-2C Δ	36-Compartment with 2 Extenders	2.69"	6.34"	410, 411, 412, 413, 414	3 ea	27.10/5.46
RG36-3C Δ	36-Compartment with 3 Extenders	2.69"	7.94"	410, 411, 412, 413, 414	2 ea	22.70/4.45
RG36-4C Δ	36-Compartment with 4 Extenders	2.69"	9.5"	410, 411, 412, 413, 414	2 ea	26.00/5.30
RG36-5C Δ	36-Compartment with 5 Extenders	2.69"	11.1"	410, 411, 412, 413, 414	2 ea	28.10/6.12
RE36C	36-Compartment Divided Extender	2.69"	1.5"	04, 05, 09, 24, 89	6 ea	13.35/2.77

49-Compartment

- Ideal for juice glasses, narrow champagne flutes, cordials, and shot glasses

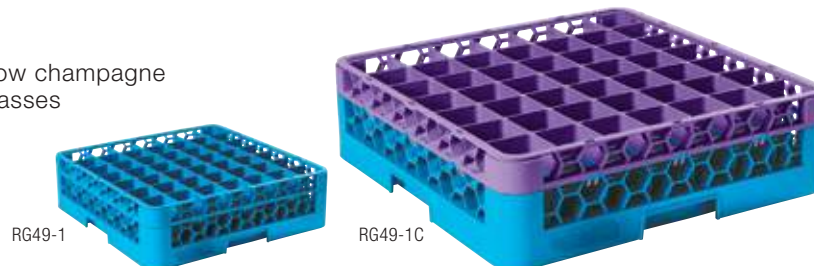

Prod No	Description	Glass Dia**	Glass Height	Color	Pack
49-Compartment Glass Rack—Compartment Size 2.38" Square					
RG49 Δ	49-Compartment	2.13"	3.19"	14	6 ea
RG49-1 Δ	49-Compartment with 1 Extender	2.13"	4.75"	14	4 ea
RG49-2 Δ	49-Compartment with 2 Extenders	2.13"	6.34"	14	3 ea
RG49-3 Δ	49-Compartment with 3 Extenders	2.13"	7.94"	14	2 ea
RG49-4 Δ	49-Compartment with 4 Extenders	2.13"	9.5"	14	2 ea
RE49	49-Compartment Divided Extenders	2.13"	1.5"	14	6 ea
RE*	Open Extender	—	1.5"	14	6 ea
49-Compartment Color-Coded Glass Rack—Compartment Size 2.38" Square					
RG49-1C Δ	49-Compartment with 1 Extender	2.13"	4.75"	410, 411, 412, 413, 414	4 ea
RG49-2C Δ	49-Compartment with 2 Extenders	2.13"	6.34"	410, 411, 412, 413, 414	3 ea
RG49-3C Δ	49-Compartment with 3 Extenders	2.13"	7.94"	410, 411, 412, 413, 414	2 ea
RG49-4C Δ	49-Compartment with 4 Extenders	2.13"	9.5"	410, 411, 412, 413, 414	2 ea
RG49-5C Δ	49-Compartment with 5 Extenders	2.13"	11.1"	410, 411, 412, 413, 414	2 ea
RE49C	49-Compartment Divided Extender	2.13"	1.5"	04, 05, 09, 24, 89	6 ea

NSF Listed products are designated with a Δ and may be prefixed with an N

* Note: The RE Open Extender can be used with any OptiClean Glass or Dish Rack

**Dimensions shown are for the recommended maximum glass size for the compartment

OPTICLEAN®

Dish Racks

OptiClean Dish Racks offer the safest and most sanitary cleaning choices for everything from the most fragile tableware to heavy-duty kitchen items such as utensils and cutlery. These racks are NSF Listed and offer all the same great features as the rest of Carlisle's wash racks such as sturdy double wall construction and Comfort Curve™ Handles molded into all four sides.



Peg Racks

- Holds plates, trays, and platters at the best angle to take full advantage of today's multiple spray, high-pressure dishwashers
- Plate locks hold dishes firmly in place to protect delicate rims, reduce chipping and breakage
- Use with additional Open Extenders (RE) to create the perfect rack for irregular or oversize drinkware
- NSF Listed

Tall Peg Plate & Tray Rack

- Extra tall 2.94" pegs are ideal for charger plates, pasta bowls, large platters, and trays

Open End Peg Rack

- Tall 2.94" pegs with open ended design hold all types of trays, standard size baking sheets, and other long items

Open/Bowl Rack

- Sturdy open bottom rack is ideal for all large bowls, containers, brushes, cookware, and cutlery

Combination/Flatware Rack

- Bottom grid allows for free flow of water and air
- Keeps flatware in place for thorough washing and drying
- Perfect for ramekins, and other small items
- NSF Listed



RTP

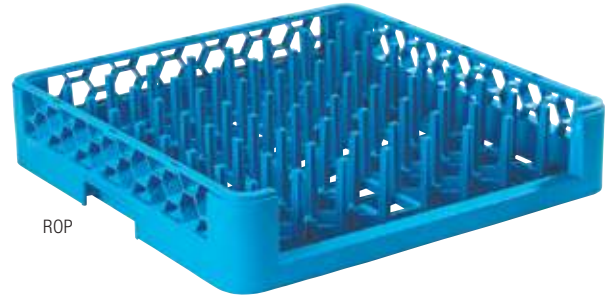

ROP



RB



RF



Blue(14)

Prod No	Description	Color	Pack
Peg Racks & Extender			
RP	All-Purpose Plate & Tray Rack	14	6 ea
RTP Δ	Tall Peg Plate & Tray Rack	14	6 ea
ROP Δ	Open End Peg Rack	14	6 ea
RE*	Open Extender	14	6 ea
Open/Bowl Rack & Extender			
RB Δ	Open/Bowl Rack	14	6 ea
RE*	Open Extender	14	6 ea
Combination/Flatware Rack			
RF Δ	Combination/Flatware Rack	14	6 ea
RE*	Open Extender	14	6 ea

NSF Listed products are designated with a Δ and may be prefixed with an N

* Note: The RE Open Extender can be used with any OptiClean Glass or Dish Rack

Cup Racks

- Tilted design promotes thorough washing of rims and interiors
- Encourages bases to drain more efficiently
- 16-Compartment holds larger diameter cups and mugs in tilted position; compartment size: 4.34" x 4.34"
- 20-Compartment works with most standard size cups; compartment size: 4.34" x 3.41"
- NSF Listed



Bakery Tray & Sheet Pan Rack

- Rack securely holds sheet or bun pans low enough to fit standard height dish machine openings
- Contents are angled to take full advantage of multiple spray arms
- NSF Listed



Food Pan/Insulated Meal Delivery Tray Rack

- Accommodates all sizes of 2.5" deep food pans and standard steam table inserts
- Racks are angled for thorough cleaning
- Perfect for health care or correctional facilities using insulated meal delivery compartment trays
- NSF Listed



Plate Cover Rack

- Use with plate covers, dishwasher safe insulated dome covers, or dishwasher safe pellet bases
- Specially designed insert keeps contents separated during washing
- NSF Listed



Blue(14)



RC20-1



RSP



RFP



RPC

Prod No	Description	Color	Pack
Cup Racks			
RC16 Δ	16-Compartment Cup Rack	14	6 ea
RC16-1 Δ	16-Compartment Cup Rack with 1 Open Extender	14	4 ea
RC20 Δ	20-Compartment Cup Rack	14	6 ea
RC20-1 Δ	20-Compartment Cup Rack with 1 Open Extender	14	4 ea
Bakery Tray & Sheet Pan Rack			
RSP Δ	Bakery Tray & Sheet Pan Rack	14	3 ea
Food Pan/Insulated Meal Delivery Tray Rack			
RFP Δ	Food Pan/Insulated Meal Delivery Tray Rack	14	3 ea
Plate Cover Rack			
RPC Δ	Plate Cover Rack	14	3 ea

NSF Listed products are designated with a Δ and may be prefixed with an N
 * Note: The RE Open Extender can be used with any OptiClean Glass or Dish Rack



OPTICLEAN® ACCESSORIES

Hold Down Grid

- Use with small, light-weight, or delicate items to prevent them from being displaced by high pressure sprayers
- Snaps down securely and fits all OptiClean Glass & Dish Racks
- NSF Listed



Half Size Stack-All™ Racks

- Compact 10" x 19.75" size will work in any 19.75" dishwasher
- Sturdy single wall construction
- Open design for superior water and air circulation
- Made of high impact polypropylene
- NSF Listed



Perma-Sil™ Cylinders & Carriers

Flatware Cylinders

- Meshed bottom and open sides are best for the dispersion of water and air; ideal for washing or storing flatware



Carriers

- Heavy gauge wire construction is chrome plated
- Vinyl-coated insulated handle

Perma-San™ Flatware Washing Baskets

- Open design for easy cleaning of vertically stored flatware
- Use with RF Flatware Rack or RB Open/Bowl Rack as part of a complete flatware sanitizing system
- Tough polypropylene material resists grease and detergents
- C32P1 and C32P2 are NSF Listed

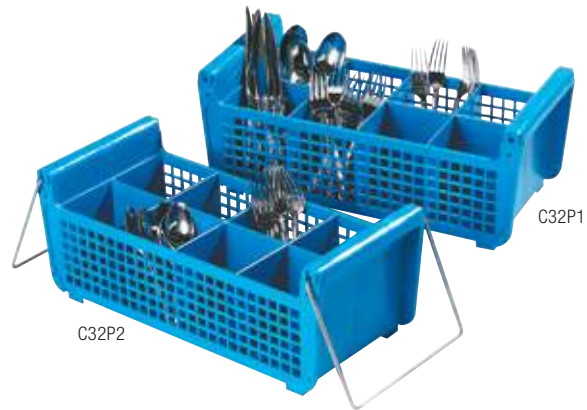

Prod No	Description	Glass Height	Color	Pack
Hold Down Grid				
C93 ▲	Vinyl Coated Wire Grid	—	14	6 ea
Half Size Stack-All Racks				
C135 ▲	Open Bowl/Cup/Glass Rack	4.5"	14	6 ea
C111 ▲	Flatware Rack	4.5"	14	6 ea
Perma-Sil Cylinders & Carriers				
C35P	Poly Cylinder	—	02	12 ea
CW6C	6-Compartment Portable Carrier	—	38	6 ea
C32P1 ▲	Flatware Basket without Handles	—	14	6 ea
C32P2 ▲	Flatware Basket with Handles	—	14	6 ea

NSF Listed products are designated with a ▲ and may be prefixed with an N

E-Z Glide™ Rack Dollies

Aluminum Dollies

- Hold and transport any 19.75" square stack of glass racks
- Large 4" ball bearing swivel casters with non-marking rubber wheels
- 300 lb weight capacity

Polypropylene Dollies

- C2236/C2236H injection molded dollies squared corners are designed to hold any standard 19.75" racks including older style square racks
- 350 lb weight capacity
- Dollies trap water from wet racks; convenient drain feature makes emptying water easy



Dust Cover

- Heavy-duty vinyl covers keep tableware clean during storage
- Easily converts warewashing racks into storage racks
- Combine with E-Z Glide Dollies and Rack Covers (shown left) for a complete storage system



Rack Cover

- Hard cover protects rack contents during storage

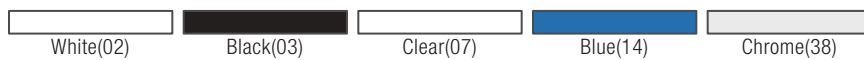

Prod No	Description	Color	Pack
E-Z Glide Rack Dollies			
C2220A	Open Aluminum Dolly, No Handle	14	1 ea
C2222A	Open Aluminum Dolly with Handle	14	1 ea
C2236	Warewashing Rack Dolly, No Handle	03, 14	1 ea
C2236H	Warewashing Rack Dolly with Handle	03, 14	1 ea
C2237	Handle for C2236 & C2236H		1 ea
C2222C	Replacement Caster for C2220A & C2222A		1 ea
C2222HD	Handle for C2220A & C2222A	38	1 ea
Rack Cover			
RHC	Rack Cover	02	1 ea
Dust Covers			
RDC ▼	36" Long Rack Dust Cover	07	3 ea
RDC1 ▼	48" Long Rack Dust Cover	07	3 ea

NSF Listed products are designated with a **Δ** and may be prefixed with an N

WARNING: Products identified on this page with the following symbol ▼ contain chemicals, including one or more phthalates, known to the State of California to cause cancer and birth defects and other reproductive harm.

PLAQUE-A-RACK

Carlisle's Plaque-A-Rack System is the proven standard in custom rack labeling. The highly visible plaques fit up to three across on both bases and extenders for complete versatility. Plaques can be easily added, removed, or changed as needed. Sturdy reusable plaques are made from a high-impact plastic and won't come off during the normal wear and tear of daily usage – offering a permanent identification system for the life of your racks.



Plaque example shown above: XRG25-2 with 203, 303, 103

- Plaque-A-Rack provides four ways to customize your Glass Rack System:
 - glassware silhouette
 - glassware style by name
 - location of glassware usage or storage
 - custom color coding options
- Plaques are hot stamped for durability
- Plaques are Carlisle Blue(14), unless otherwise specified
- All plaques are 3" long by 1" high
- Racks can be ordered with up to three possible plaque imprints
- There is a \$4.16 U.S. list price charge per rack for each Plaque-A-Rack order (includes 2 plaques on 2 sides); special orders for plaques on all four sides have a \$8.32 U.S. list price (includes 2 plaques on 4 sides)
- Plaques may also be ordered separately at \$1.04 U.S. list price each
- Plaques are placed horizontally on two opposite sides of the rack along the top most edge
- Plaques snap on for a tight fit; won't fall off during normal use
- Plaques can be removed if necessary and are re-usable
- Allow ten working days for shipment of your standard order
- Plaqued racks sold in full case quantities only
- Please allow 4-6 weeks from approval of sample for custom plaques
- Custom imprinted plaques are \$1.04 U.S. list price each with an additional \$50 U.S. net price setup fee per plate
- An additional \$142 U.S. net price dye charge will apply to any plaque order that does not include racks
- For custom color coding, please specify which color is to be used for each rack
- Custom plaques have a max of 9 characters in upper/lower case; 7 character max in all caps
- All plaque sales are final

How To Order

Follow instructions below and refer to the charts on the facing page for catalog numbers.

Step 1: Choose the glass rack that best fits your glassware.

Step 2: Plaque-A-Rack glass racks are identified by an "X" preceding the standard glass rack catalog number (example: "X"RG25-1 25-Compartment Plaque-A-Rack glass rack with one extender).

Step 3: Choose the different imprints you want from the types of plaque imprints available.

- Silhouette
- Name of glassware
- Location

Step 4: Place the three digit plaque catalog imprint product number next to the standard glass rack catalog number.

EXAMPLE:

Rack Choice: RG25-1
 Silhouette: Red Wine
 Glassware Name: Red Wine
 Location: Service Bar
 Catalog No: XRG25-1 204 304 104

Standard Color



Custom Colors

- Minimum order 36 pieces































LOCATION

GLASS RACK

CAT. NUMBER	IMPRINT	CATALOG NUMBER		
100	(BLANK)	XRG16	XRG25-2	XRG36-4
101	KITCHEN	XRG16-1	XRG25-3	XRG9
102	DINING	XRG16-2	XRG25-4	XRG9-1
103	BANQUET	XRG16-3	XRW30	XRG9-2
105	POOLSIDE	XRG16-4	XRW30-1	XRG9-3
106	STORAGE	XRW20	XRW30-2	XRG49
107	RM SERV	XRW20-1	XRW30-3	XRG49-1
108	BALLROOM	XRW20-2	XRG36	XRG49-2
109	BAR	XRW20-3	XRG36-1	XRG49-3
110	HOUSEKEEPING	XRG25	XRG36-2	
		XRG25-1	XRG36-3	

SILHOUETTE		NAME OF GLASS		SILHOUETTE		NAME OF GLASS	
CAT.#	IMPRINT	CAT.#	IMPRINT	CAT.#	IMPRINT	CAT.#	IMPRINT
PLQ	(BLANK)	PLQ	(BLANK)	214		314	MUG
201		301	CHAMPAGNE	215		315	FOOTED CUP
202		302	CHAMPAGNE	217		317	HI BALL
203		303	WHITE WINE	218		318	ICED TEA
204		304	RED WINE	219		319	FLUTED
205		305	ROCKS	221		321	GOBLET
206		306	WATER	222		322	WINE
207		307	COOLER	224		323	MARGARITA
208		308	PILSNER	226		324	BEER
209		310	PARFAIT	227		326	HURRICANE
211		311	BRANDY	228		327	MARTINI
212		312	TULIP	229		328	CORDIAL
213		313	SOUR	230		329	DESSERT
				235		330	CUP
						335	OLD FASHION
						633	COFFEE CUP

BUS BOXES

Tote Boxes

- Unique reinforced rims reduce bending, bowing, and breaking
- Excellent for storing and separating food products
- Comfort Curve™ handles for a sure, comfortable grip
- Contour lid design allows easy box-on-box stacking
- Available in 8 different colors for HACCP zone use
- NSF Std 21 – meets the criteria for thermoplastic refuse containers
- NSF Std 2 – meets the criteria for food contact and cleanability

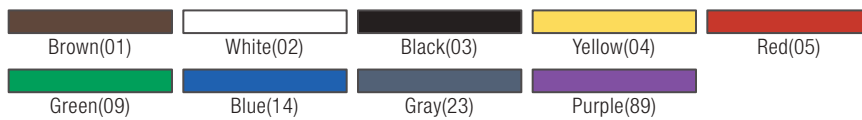

Prod No	Description	Color	Pack
Tote Boxes			
N44010 Δ	Tote Box 15" x 20" x 5" Deep	01, 02, 03, 04, 05, 09, 14, 23, 89	12 ea
N44011 Δ	Tote Box 15" x 20" x 7" Deep	01, 02, 03, 04, 05, 09, 14, 23, 89	12 ea
N44012 Δ	Universal Lid	01, 02, 03, 04, 05, 09, 14, 23, 89	12 ea

NSF Listed products are designated with a Δ and may be prefixed with an N

Save-All™ Compartmented Bus Boxes

- Silverware tray and heavy-duty bus boxes feature contoured handles for easy handling
- Scuff, grease, and stain-resistant
- Silverware Tray measures 21.25" x 11.5" x 3.75" H
- 0386 Save-All Bus Box has separate compartments, one for flatware, one for plates and debris; measures 22" x 17" x 5" H
- Dishwasher safe



Bus Boxes

- Unique reinforced rims reduce bending, bowing, and breaking – protecting your valuable tableware investment
- Comfort Curve™ handles for a sure, comfortable grip
- Contour lid design allows easy box-on-box stacking
- 44010, 44011, 44012 in White are NSF Listed



44011SKD

Prod No	Description	Color	Pack
Save-All Compartmented Bus Boxes			
1071	Save-All Silverware Tray	23	6 ea
0386	Save-All Bus Box	23	12 ea
Bus Boxes			
44010	Bus Box 15" x 20" x 5" Deep	01, 02, 03, 23	12 ea
44011	Bus Box 15" x 20" x 7" Deep	01, 02, 03, 23	12 ea
44012	Universal Lid	01, 02, 03, 23	12 ea
44010SKD*	Bus Box Skid 15" x 20" x 5" Deep	03, 23	300 ea
44011SKD*	Bus Box Skid 15" x 20" x 7" Deep	03, 23	240 ea

*Note: 44010SKD, 44011SKD cannot ship UPS/FedEx Ground



CARLISLE
FOODSERVICE PRODUCTS

PROVEN EFFICIENT RELIABLE CLEANING TOOLS

Trust Carlisle's equipment cleaning brushes and kitchen tools to help keep your food service operation healthy, safe and profitable. These products are another way Carlisle helps you make work easy.



SPARTA



The Right Brush For Every Job

We offer more than 2,000 brushes and cleaning tools, each ergonomically designed with the end user in mind to provide optimum cleaning results for *you*.

Since 1908

we've been manufacturing high-quality brushes and cleaning tools. We have developed unmatched expertise, consistently delivering innovative cleaning solutions.

The Highest Quality

and best suited materials for efficient use and durability. These outstanding Sparta Brush features save you time and money.

Custom Designed

for each specific cleaning application.

Proven

Sparta Brush quality excels in foodservice and food processing including fine restaurants, hotels, schools, hospitals, lunch counters, cafeterias, supermarket bakeries, meat departments and delicatessens.

Our Commitment

to the customer never ends, and our mission is to give 100% customer satisfaction.

SPARTA
BRUSH



Maintain a healthy foodservice environment with the **Sparta® 21 Key Brush** solution!

This program is specifically tailored for food service operators to help you prevent the spread of food-borne illness and comply with FDA Food Codes

PASTRY & BASTING



#1 Hot Use
40374



#2 Cold Use
40401



#3 Silicone Basting Brush
40405

FLOOR CLEANING



#4 24" Double Foam Rubber Squeegee
40082



#5 Hi-Lo™ Floor Scrub
40423



#6 Duo-Sweep™ Angle Broom
36885



#7 24" Omni® Floor Sweep
41881

FOOD PREPARATION



#8 Vegetable Brush
40164



#9 6" Cutting Board Brush
40521

GENERAL CLEANUP



#10 8" Polyester Scrub Brush
40541



#11 20" Polyester Scrub Brush
40501



#12 Scratch Brush with Scraper
40671

KITCHEN EQUIPMENT



#13 Broiler Master Brush
40290



#14 L-Tipped Teflon Fryer Brush
40111

BEVERAGE SERVICE



#15 12" Carafe/Bottle Brush
40000



#16 Coffee Decanter Brush
40025

FLOOR DRAIN CLEANING



#17 Floor Drain Brush
40146



#18 36" Plastic Drain Brush Handle
40236



#19 Drain Opening Tool
40144

WASHROOM & PERSONAL HYGIENE



#20 Hand and Nail Brush
40020



#21 Polyester Bowl Brush
40140

21 Key Brush Kit - 990021KIT00

21 KEY BRUSHES

#3 Silicone Basting Brush **40405**

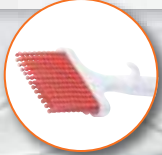

#13 Broiler Master Brush **40290**



#14 L-Tipped Teflon Fryer Brush **40111**



#12 Scratch Brush w/ Scraper **40671**



#1 Hot Use **40374**



#2 Cold Use **40401**



#5 Hi-Lo Floor Scrub **40423**



#17 Floor Drain Brush **40146**



#18 36" Plastic Drain Brush Handle **40236**



#19 Drain Opening Tool **40144**



#10 8" Polyester Scrub Brush **40541**



21 Key Brush Kit - 990021KIT00

#16 Coffee Decanter
Brush **40025**

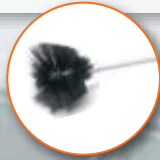

#15 12" Carafe/Bottle
Brush **40000**



#20 Hand & Nail
Brush **40020**



#21 Polyester Bowl
Brush **40140**



#8 Vegetable
Brush **40164**



#11 20" Polyester
Scrub Brush **40501**



#9 6" Cutting
Board Brush **40521**



#4 24" Double Foam
Rubber Squeegee **40082**



#6 Duo-Sweep™ Angle
Broom **36885**



#7 24" Omni® Floor
Sweep **41881**



SMALLWARES BRUSHES

Atlas Multi-Purpose Brushes

- Versatile design for a wide variety of applications
- Multiple trim angles on bristles give you better surface contact for better cleaning
- Available with ergonomic pistol grip handles in 8" and 20" lengths
- Rugged plastic handles and crimped staple set polyester bristles will not absorb oils or moisture
- Base resins used to produce blocks and bristles are made of FDA compliant materials



Cutting Board Brushes

- Ergonomically shaped handles and crimped stapleset polyester bristles are rugged and will not absorb food oils or moisture
- Segregate brushes and boards by color to help prevent cross contamination
- Base resins used to product blocks and bristles are made of FDA compliant materials



	Allergen Control
	Dairy or Dry Food
	Produce
	Prepared Food
	Meat
	Fish
	Poultry

White(02)	Yellow(04)	Red(05)	Green(09)
Blue(14)	Tan(25)	Purple(68)	Purple(89)

Prod No	Description	Recommended Cleaning	Color	Pack
Atlas Multi-Purpose Brushes				
40000	12" Handle, 2.75" Round with Soft Polyester Bristles	Drinkware/Dishes	02, 04, 05, 09, 14	12 ea
40001	16" Handle, 3.25" Round with Soft Polyester Bristles	Drinkware/Dishes	02, 04, 05, 09, 14, 68	12 ea
40002	16" Handle, 3.5" x 5" Oval with Polyester Bristles	Pots/Pans/Tanks	02, 04, 05, 09, 14	6 ea
40003	30" Handle, 3.5" x 5" Oval with Polyester Bristles	Pots/Pans/Tanks	02, 04, 05, 09, 14	6 ea
40004	16" Handle, 3" Round with Polyester Bristles	Pots/Pans/Tanks	02, 04, 05, 09, 14	6 ea
40006	30" Handle, 3" Round with Polyester Bristles	Pots/Pans/Tanks	02, 04, 05, 09, 14	6 ea
40005	16" Handle, 4" Round with Polyester Bristles	Pots/Pans/Tanks	02, 04, 05, 09, 14	6 ea
40007	30" Handle, 4" Round with Polyester Bristles	Pots/Pans/Tanks	02, 04, 05, 09, 14	6 ea
40010	16" Handle, 5" Round with Polyester Bristles	Pots/Pans/Tanks	02, 04, 05, 09, 14	6 ea
40008	30" Handle, 5" Round with Polyester Bristles	Pots/Pans/Tanks	02, 04, 05, 09, 14	6 ea
Cutting Board Brush				
40521	6" Cutting Board Brush with Polyester Bristles, 1.38" trim	—	02, 04, 05, 09, 14, 25, 89	12 ea

SMALLWARES BRUSHES

Sparta® Glass Washing Brushes

- All plastic construction helps prevent glasses from being chipped or broken and helps seal out moisture
- Positive-suction, molded plastic base provides a tight grip in sinks and on countertops
- Heavy-duty polyester bristles with densely filled dome top holds up to extreme use



**New
Cash 'N Carry
Package**

Sparta Bottle & Jar Brushes

- Wirewound brushes have a small diameter handle and soft bristles for easy and delicate cleaning of jars, bottles, and glasses with smaller openings
- 40415 Bottle Brush is perfect for cleaning wine bottles, ketchup bottles, squeeze bottles, beer growlers, etc.

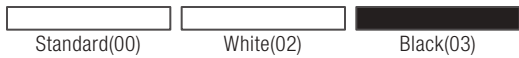

Prod No	Description	Recommended Cleaning	Color	Pack
Sparta Glass Washing Brushes				
40460	8" Twin Glass Washer, 2.88" trim	Drinkware	03	6 ea
40461	8" Triple Glass Washer, 2.88" trim	Drinkware	02, 03	6 ea
41506	9.5" Pilsner, Hurricane & Standard Style Triple Glass Washer	Drinkware	00	6 ea
40465	Standard Refill Brush	Drinkware	03	12 ea
40462	Shot Glass Cleaning Brush	Drinkware	03	6 ea
Sparta Bottle & Jar Brushes				
40466	12" Handle Pint Bottle Brush with Polyester Bristles, 2.5" - 3.5" trim	Jars/Carafes/Bottles	00	12 ea
40467	16" Handle Quart Bottle Brush with Polyester Bristles, 3" - 4.25" trim	Jars/Carafes/Bottles	02	12 ea
40468	16" Handle Half Gallon Brush with Polyester Bristles, 4" - 4.5" trim	Jars/Carafes/Bottles	00	12 ea
40415	16.5" Handle Small Bottle Neck Brush with Soft Nylon Bristles	Small Neck Bottles	00	12 ea

SPECIAL EQUIPMENT BRUSHES

Hot Dog Roller Brush

- Special "V" shaped stiff polyester bristle design cleans hot dog rollers and connecting points at the side walls at one time
- Rids hot dog roller grills of unsanitary grease build-up that could result in mechanical problems



High Temp Fryer Brushes

- Made of stiff, PTFE bristles that withstand temperatures up to 500°F
- Saves time since equipment can be cleaned while hot
- Plastic handles stay cool to the touch
- 40110 Fryer Brush is 28" long to reach tight, narrow spaces
- 40112 Looped Brush cleans fryer bottoms easily
- 40111 and 40116 L-Tipped Fryer Brush for cleaning hot coils
- 40113 Utility Brush for cleaning hot vats, utensils and other equipment



High Temp Waffle & Panini Griddle

- Made of stiff, Teflon®* bristles that withstand temperatures up to 500°F
- Saves time since equipment can be cleaned while hot
- Plastic handles stay cool to the touch
- 40114 has extra stiff bristles for cleaning waffle irons, griddles, and grills while still hot
- 40115 is a pastry style brush designed for buttering and basting hot surfaces



Prod No	Description	Trim	Color	Pack
Hot Dog Roller Brush				
41169	24" L Hot Dog Roller Brush	2"	00	12 ea
High Temp Fryer Brushes				
40110	28" Straight Fryer Brush with Teflon Bristles	1.38"	05	12 ea
40112	24" Looped Fryer Brush with Teflon Bristles	2"	05	6 ea
40111	23" L-Tipped Fryer Brush with Teflon Bristles	.88"	05	12 ea
40113	20" Utility Brush with Teflon Bristles	2"	05	12 ea
High Temp Waffle, Griddle & Equipment Brushes				
40114	3" Wide Brush with Teflon Bristles	.94" - 1"	00	12 ea
40115	1" Round Brush with Teflon Bristles	2"	00	12 ea

NOTE: Heat coil must be turned off prior to using high temperature brushes

Sparta Coffee Service Brushes

- Brushes are designed to clean all glass and Pyrex® pots and dispensers
- 40025 Coffee Decanter Brush is shaped like the inside of the most popular coffee decanters for quick and easy use
- Use 40673 Urn Brush for quick and easy clean-up of glass gauges on coffee urns
- 40154 Creamer and Percolator Brush is designed for cleaning spouts and tubing on percolators, hot beverage servers, and creamers
- 40153 Curved Coffee Maker Brush is a semi-circular wire wound brush that contours to the inside of coffee pots



Spouts, Pumps & Valves - Stiff Polyester Bristles

Tee, Fitting, and Valve Brush (40180)

- Perfect for straight pipes, tees, and valves

Condiment Dispenser Spout Brush (40155)

- Flexible wire for efficient cleaning of bacteria prone spouts

Condiment Dispenser Plunger Brush (40156)

- Rose-bud tip for efficient dispenser cleaning

Beer Tap Line Brush (40157)

- Great for maintaining quality control of beer on tap



Prod No	Description	Recommended Cleaning	Color	Pack
Sparta Coffee Service Brushes				
40025	16" Coffee Decanter Brush with Soft Polyester Bristles, 4.6" - 6.4" trim	Coffee Decanter	00	6 ea
40673	25" Handle Urn Brush with Polyester Bristles, .63" trim	Coffee Urn & Tap	00	12 ea
40154	12" Creamer Brush with Polyester Bristles, 1" x 1.5" trim	Coffee Spout	00	24 ea
40153	10" Curved Coffee Maker Brush with Soft Polyester Bristles, 1.5" trim	Coffee Maker	00	12 ea
Spouts, Pumps & Valve Brushes				
36552	8" Spout Brush	Spouts/Faucets	00	144 ea
40157	5.25" Beer Tap with Polyester Bristles, .25" trim	Beer Taps	00	24 ea
40180	15" Valve & Fitting with Polyester Bristles, 1" trim	Valves & Fittings	02	12 ea
40155	13" Spout Brush with Polyester Bristles, .44" trim	Condiment Pumps	00	12 ea
40156	10.5" Plunger Brush with Polyester Bristles, .94" trim	Condiment Pumps	00, 14	12 ea

EQUIPMENT CLEANING BRUSHES

Wok/Gong Utility Brushes

- Clean woks and electric griddles; designed specifically for high heat cleaning
- Wood block handle available in two lengths
- Stiff palmyra bristles are excellent for general cleaning



Low Temperature Equipment Brushes

- 40040 and 40042 Tank and Kettle Brushes have bristles on all sides to provide complete cleaning and can be used with a handle to reach the bottom of kettles and tanks
- 40150 Kettle Drain Valve Brush is a perfect solution for cleaning bacteria prone areas of kettles
- 40152 Cool Temperature Fryer Brush has the same shape as our High Temp Fryer Brush(40111) but is used in cool cleaning



Dishwasher Machine Brush

- Long handle reaches spray arms for more thorough cleaning



Standard(00)

Prod No	Description	Recommended Cleaning	Color	Pack
Wok/Gong Utility Brushes				
45463	8.5" Utility Scrub Brush with Stiff Palmyra Bristles	Wok/Gong/Electric Griddles	00	12 ea
45493	20" Utility Scrub Brush with Stiff Palmyra Bristles	Wok/Gong/Electric Griddles	00	12 ea
Low Temperature Equipment Brushes				
40040	Tank & Kettle Brush with Nylon Bristles, 5.25" x 7.5" trim	Kettle & Tank	00	12 ea
40042	Tank & Kettle Brush with Nylon Bristles, 5.5" x 9.5" trim	Kettle & Tank	00	12 ea
40150	28" Kettle Valve with Stiff Polyester Bristles, 1.38" trim	Kettle Valve	00	12 ea
40152	23" Cool L-Tipped Fryer with Polyester Bristles, .88" trim	Fryer	00	12 ea
Dishwasher Machine Brush				
40028	35" Dishwasher Spray Arm with Polyester Bristles, 1" trim	Dishwasher	00	12 ea

Bake Pan Lip Brush

- Easy cleaning of rolled lips and edges on baking pans
- Stiff polyester bristles patterned in a flat V-shape for maximum pan contact
- Contoured handle provides a convenient grip and protects hands from metal edges on pans and other equipment



40024

Vegetable Cutter Brushes

- 40529 has 2.5" long, extra stiff nylon bristles reach through the grid of stainless steel cutters
- 40532 has 4.25" long, extra stiff, nylon bristles



Iron Handle Brush

- Pointed edge to allow cleaning in corners
- Iron style grip is ergonomically designed for comfort and light or medium duty scrubbing



Prod No	Description	Recommended Cleaning	Color	Pack
Bake Pan Lip Brush				
40024	6" Bake Pan Lip Brush with Polyester Bristles, 1" trim	Baking Pans	02, 04, 05, 09, 14	12 ea
Cutter Brush				
40529	2.5" Vegetable Cutter Brush with Nylon Bristles, 2" trim	Lettuce & Onion Cutters	00	12 ea
40532	4.25" Universal Onion/Lettuce Brush	Lettuce & Onion Cutters	00*	8 ea
Iron Handle Brush				
36289	6" Iron Handle Brush with Polypropylene Bristles	Medium Scrubbing/Corner Areas	00	48 ea

EQUIPMENT CLEANING

Toothbrush Style Utility Brushes

- Narrow profile cleans tight kitchen spaces and around ceramic tile
- Available in a choice of .5" long stiff nylon bristles for normal cleaning; stainless steel or brass bristles for tougher cleaning jobs



Butcher Block Brushes

- Aggressive tempered steel wire bristles scrape away contaminated layers of wooden butcher blocks and wooden cutting boards



Meat Slicer Cleaning Tool

- Keeps hands and fingers away from slicer blade
- Easy clean-up of slicers without disassembling slicer
- Slicer tool has scraper on one end for scraping hardened foods
- Scrub pad wraps around meat slicer tool for a one-time thorough cleaning



Prod No	Description	Recommended Cleaning	Color	Pack
Toothbrush Style Utility Brushes				
40674	7" Plastic Handle with .5" Nylon Bristles	Tile/General Purpose	00	12 ea
40675	7" Plastic Handle with .5" Stainless Steel Bristles	Ovens/Grills/Small tough areas	00	12 ea
41270	7" Plastic Handle with .5" Brass Bristles	Ovens/Grills/Small tough areas	00	12 ea
Butcher Block Brushes				
40676	4" x 9" Brush with Flat Steel Bristles	Butcher Block	00	12 ea
45781	2.63" x 7.75" Brush with Steel Bristles	Butcher Block	00	12 ea
Meat Slicer Cleaning Tool				
40728	Meat Slicer Cleaning Tool	Meat Slicer Blade	25	12 ea
40729	Meat Slicer Scrub Pad	Meat Slicer Blade	08	12 pk

DISHWARE CLEANING

Scrubs & Sponges

- 36752 is a long-lasting 400 series stainless that won't rust or splinter
- 36396: aggressive pad for use in place of steel wool - not recommended for coated cookware, soft plastics, fine china or polished stainless steel as scratching can occur



Dish Brushes

- 40413 has a 180° brush head and full end bristles to prevent splash back when in use cleaning dishes, utensils and fry pans
- 3610140 is perfect for scraping off food before placing in dishwasher



Standard(00) White(02)

Prod No	Description	Recommended Cleaning	Color	Pack
Scrubs & Sponges				
36396	9" x 6" x .25" Medium Duty Scour Pad 10 ea/pack, 6 packs/case	Pots/Pans/Equipment	08	6 ea
36752	35 g Stainless Steel Scrub, 400 Series 12 ea/pack, 6 packs/case	Pots/Pans/Oven	00	6 ea
365501	8.25" x 4.25" x 2.25" Extra Large Sponge	Dishes	00	24 ea
Dish Brushes				
40413	12" Handle Dish Brush with Polyester Bristles, 2.75" trim	Dishes/Utensils	00	12 ea
367600TC	11" Handle Dish Brush with Polyester Bristles, 2.75" trim	Dishes/Utensils	02	6 ea
3610140	8" Dish & Sink Brush	Dishes/Utensils	00	48 ea

EQUIPMENT CLEANING

Oven & Grill Brushes

- Wire brushes and stainless steel metal scrapers make quick and easy removal of heavy carbon deposits, rust, and burned-on food build up

Broiler Master

The best grill brush available and master of all grill cleaning tools. Rust-proof bristles are embedded in a rugged specially treated hardwood block for long-lasting cleaning power.



Double Broiler King 40294

- Sturdy construction with two heads featuring carbon steel flat bristles on one side and carbon steel wire bristles on the other; bolted together on a heavy hardwood handle for very heavy use

Oven Brush 41520 & 40291

- Crimped brass wire bristles and a full length stainless steel scraper for cleaning high-temperature stack ovens

Oven Brush 40293

- Crimped brass wire bristles and a full length aluminum scraper on a low-profile head for cleaning the narrow spaces inside pizza ovens

Pizza/BBQ Oven Brush 45772

- Steel wire bristles and permanent 39" hardwood handle

Oven & Grill Brush 363725

- Flat wire stainless steel bristles, oven scraper and 30" handle



40291



40293



363725



TOP SELLER

40290



45772



40294

Standard(00)

Prod No	Description	Color	Pack
Oven & Grill Brushes			
40026	8.5" Broiler Master Brush, Carbon Steel Bristles with 30" Handle	00	6 ea
40290	8.5" Broiler Master Brush, Stainless Steel Bristles with 30" Handle	00	6 ea
40294	8" Double Broiler King, Carbon Steel Flat & Wire Bristles with 48" Handle	00	2 ea
41520	8.5" Oven Brush & Scraper, Brass Wire Bristles with 42" Handle	00	1 ea
40291	8.5" Oven Brush & Scraper, Brass Wire Bristles (Head Only)	00	12 ea
40293	10" Oven Brush & Scraper, Brass Wire Bristles (Head Only)	00	12 ea
45772	5.5" Pizza/BBQ Oven Brush, Carbon Steel Bristles and 33" Handle	00	12 ea
363725	8" Oven Brush with Scraper, Flat Wire Stainless Steel Bristles with 30" Handle	00	1 ea

NOTE: Equipment must be turned off prior to using Oven & Grill Brushes
 *40291 & 40293 do not include handles; use with handle 40275 shown on page 291



40710

Grill Bricks, Screens & Polishing Pads

- Apply with cooking oil to protect the grill, cure and remove excess cooked-on foods
- 40710 Grill Brick is a fast, efficient, and sanitary way to clean hot or cold grills
- Plastic wrapping on Grill Brick dissolves to eliminate mess
- 40713 Grill Screen and 40711 Grill Polishing Pad attach to the 40712 Grill Pad Holder for a complete grill maintenance system



40713

40711



40712

Scratch Brushes

- Compact profile for heavy scraping and cleaning in tight, narrow spaces; provides quick, aggressive removal of grease and deposits
- Available with wood handles for cleaning hot grills and ovens
- Available in nylon, stainless steel, or carbon steel wire bristles for normal to tougher cleaning jobs



45779

40671

40670

40672

40027

45571

Standard(00)

Prod No	Description	Handle	Color	Pack
Grill Bricks, Screens & Polishing Pads				
40710	3.5" x 4" x 8" Grill Brick	—	00	12 ea
40711	4" x 5" x .25" Grill Polishing Pads, 10 ea/pack, 6 pks/case	—	00	6 pks
40712	Grill Pad Holder	Plastic	00	10 ea
40713	4" x 5.5" Grill Screen, 20 ea/pack, 10 pks/case	—	00	10 pks
Scratch Brushes				
45779	11" Brush & Scraper with Carbon Steel Bristles	Wood	00	12 ea
40671	11.5" Scratch Brush & Scraper with Carbon Steel Bristles	Plastic	00	12 ea
40670	11.5" Scratch Brush with Carbon Steel Bristles	Plastic	00	12 ea
40672	11.5" Scratch Brush & Scraper with Stainless Steel Bristles	Plastic	00	12 ea
40027	11.5" Scratch Brush with Nylon Bristles	Plastic	00	12 ea
45571	20" Brush & Scraper with Carbon Steel Bristles	Wood	00	12 ea

NOTE: Equipment must be turned off prior to using Scratch Brushes

HAND & NAIL

Reduce the risk of foodborne illness breakouts with our hand & nail brushes. Every wash station in a foodservice operation should have a Carlisle Hand & Nail Brush.

Hand & Nail Brushes

- Designed to promote vital cleansing of hands for foodservice personnel
- 40020 has stiffer center bristles for a more thorough cleaning under fingernails and longer bristles along the sides clean finger's top and bottom
- 40021 kit includes 5" x 2" brush, cord to secure brush in place, hanging hook and an adhesive backed hand washing instructions decal in English and Spanish



36239



40021



40020



Standard(00)

Prod No	Description	Recommended Cleaning	Color	Pack
Hand & Nail Brushes				
36239	3.5" Plastic Block Hand & Nail Brush	Hands & Nails	00	24 ea
40020	5" Handle Hand & Nail with Polyester Bristles	Hands & Nails	00	12 ea
40021	5" Handle Hand & Nail Brush Kit	Hands & Nails	00	12 ea
40022	36" Replacement Coiled Vinyl Security Line	—	00	12 ea
40023	Replacement Hook only for Hand & Nail Brush Pack	—	00	12 ea

TABLETOP & COUNTER CLEANING

Square Steri- & Suds-Pail®

- 3, 6 and 8 quart pails meet board of health & HACCP guidelines for dedicated containers
- Use Red Steri-Pails for sanitizing solutions, Green Suds-Pails for cleaning solutions
- Pails have both standard and metric measurements on the interior walls
- Helper handles for better control
- Instructions for mixing and using sanitizing solutions is printed on the pails in English and Spanish
- Made of sturdy, dishwasher safe plastic



Microfiber Cleaning/Polishing Cloths

- 36333 is great for mirrors, windows and metallic surfaces
- 36334 is great for general cleaning



Prod No	Description	Color	Pack
Square Steri- & Suds-Pail			
11828	3 qt Square Steri-Pail	05	12 ea
11829	6 qt Square Steri-Pail	05	12 ea
11830	8 qt Square Steri-Pail	05	12 ea
11831	3 qt Square Suds-Pail	09	12 ea
11832	6 qt Square Suds-Pail	09	12 ea
11833	8 qt Square Suds-Pail	09	12 ea
Microfiber Cleaning/Polishing Cloths			
36333	16" x 16" Microfiber Suede Polishing Cloth	14	12 ea
36334	16" x 16" Microfiber Terry Polishing Cloth	02, 04, 05, 09, 14	12 ea

SCRUB BRUSHES

All Purpose Utility Scrub Brushes

- Brushes offer a thick “pistol grip” block handle and short, stiff bristles for really tough cleaning
- Light-weight, break-resistant, “soak-proof” plastic handles are perfect for clean up in a foodservice environment
- Rugged construction with stapleset secure bristles

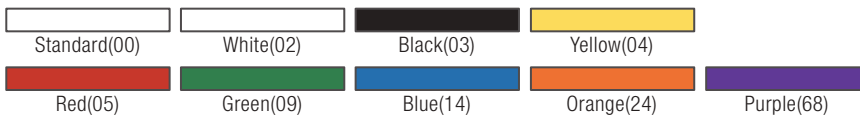

Prod No	Description	Recommended Cleaning	Color	Pack
All Purpose Utility Scrub Brushes				
40541	8" Utility Scrub Brush with Polyester Bristles, 2" trim	Pots/Pan/Medium Scrubbing	02, 03, 04, 05, 09, 14, 24, 68	12 ea
40501	20" Utility Scrub Brush with Polyester Bristles, 2" trim	Pots/Pan/Medium Scrubbing	02, 03, 04, 05, 09, 14, 24, 68	12 ea
40545	8" Brush with Medium Stiff Polyester Bristles, 1.6" trim	Pots/Pan/Medium Scrubbing	00	12 ea
40546	8" Brush with Medium Stiff Polyester Bristles, 1.6" trim	Pots/Pan/Medium Scrubbing	02	12 ea
40542	8" Brush with Medium Stiff Nylon Bristles, 1.4" trim	Pots/Pan/Medium Scrubbing	00	12 ea
40500	20" Brush with Medium Stiff Nylon Bristles, 1.6" trim	Pots/Pan/Medium Scrubbing	00	12 ea

GENERAL CLEANING BRUSHES

General Clean-Up Brushes

- 45463, 45493 have hardwood block design with stiff palmyra bristles for heavy-duty scrubbing
- Light-weight plastic handles are break-resistant, soak-proof, sanitary, and economical.



Ergonomic Hand Scrubs

- Ergonomic handles are designed for easy, no stress use
- Grips and bristles are designed to work in the most comfortable position and provide the most efficient cleaning
- Sturdy polypropylene handles with over-molded TPR Rubber are more sanitary and offer a sure grip even when wet
- Crimped bristles hold on to cleaning solutions



Prod No	Description	Recommended Cleaning	Color	Pack
Clean-Up Brushes				
365015	6" Brush with Polypropylene Bristles, 1.38" trim	Pots/Pan/Medium Scrubbing	00	12 ea
36505	8.5" Brush with Polypropylene Bristles, 2" trim	Pots/Pan/Medium Scrubbing	00, 01, 14	12 ea
36505L	20" Brush with Polypropylene Bristles, 2" trim	Pots/Pan/Medium Scrubbing	00, 14	12 ea
Ergonomic Hand Scrubs				
36506L	20" Utility Scrub with Crimped Polypropylene Bristles, 2" trim	Pots/Pan/Medium Scrubbing	03	12 ea

HAND SQUEEGEES, SCRAPERS & DUSTERS

Hand Held Window Squeegees

- Double blade red thermal rubber blades and zinc plated steel frame yields superior performance at an affordable price
- Single blade, black special blend rubber for a streak free professional finish. Zinc plated steel frame with a long handle socket that is easy to hold and fits a tapered handle

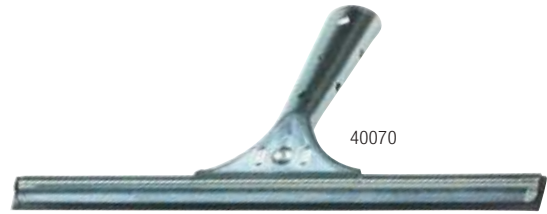

Window Scrapers

- Professional 4" wide scrapers
- 4" scraper has one sharp edge and one dull edge



Dusters

- 363404 features soft bristles for wall and ceiling dusting
- 45733 and 363156 duster have static active 100% lambswool; lambswool is electrostatically charged to attract lint and dust particles



Prod No	Description	Recommended Cleaning	Color	Pack
Hand Held Window Squeegees				
41027	12" Double-Blade with Metal Handle	Windows	00	6 ea
40074	14" Double-Blade with Metal Handle	Windows	00	12 ea
40070	12" Single-Blade with Metal Handle	Windows	00	12 ea
40071	16" Single-Blade with Metal Handle	Windows	00	12 ea
Window Scrapers				
365117	Complete Scraper with 6" Plastic Handle Head & Blade	Tables/Floors/Windows	00	10 ea
365120	4" Replacement Blade Dispenser 10 per pack/10 packs per case	—	00	10 pks
Dusters				
363404	9" Flagged Polypropylene Duster	Walls/Ceilings	14	12 ea
365450	34" – 59" Metal Telescopic Handle	Attach to 363404	00	12 ea
45733	30" – 42" Telescopic Plastic Handle with Lambswool	Vents/Blinds	00	12 ea
363156	52" – 81" Telescopic Poly Wool Duster	Vents/Blinds	00	12 ea

COUNTER & RADIATOR BRUSHES

Counter Top & Radiator Brushes

- Wide variety of bristle and handle choices
- 36211's flagged bristles are ideal for cleaning up fine particles and dust
- 45411 .5" Narrow Profile Radiator Brush cleans counter tops, between equipment and counter tops, and refrigerated cooling coils

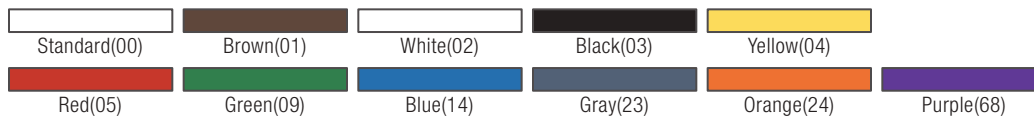

Prod No	Description	Recommended Cleaning	Color	Pack
Counter Top & Radiator Brushes				
40480	8" Plastic Handle with White Polyester Bristles, 2.5" trim	Counters/Tables	01, 02, 04, 05, 09, 14, 24, 68	12 ea
40481	8" Plastic Handle with Black Polyester Bristles, 2.5" trim	Counters/Tables	00	12 ea
40485	8" Wood Handle with Horsehair & Polypropylene Blend Bristles, 2.5" trim	Counters/Tables	00	12 ea
36211	8" Plastic Counter Brush, 2.5" trim	Counters/Tables	23, 24	12 ea
45411	24" Radiator Brush with Horsehair-Polypropylene Bristles, 2" trim	Radiators/Narrow Areas	03	12 ea

HANDLE GUIDE

Prod No	Page	Description	Type of Handle	Recommended Handle
Equipment Brushes				
40291	264	8.5" Oven Brush & Scraper	Threaded	40275
40293	264	10" Pizza Oven Brush	Threaded	40275
Hand Squeegees				
40070	270	12" Single-Blade Squeegee	Tapered	365408
40071	270	16" Single-Blade Squeegee	Tapered	365408
40074	270	14" Double-Blade Squeegee	Tapered	365408
41027	270	12" Double-Blade Squeegee	Tapered	365408



CARLISLE
FOODSERVICE PRODUCTS

DURABLE
INNOVATIVE
VERSATILE
**FLOOR &
RESTROOM
PRODUCTS**

Carlisle offers durable, innovative and versatile solutions to maintain a clean and healthy environment with a complete line of brushes, brooms, and mopping supplies.



UPRIGHT BROOMS

Carlisle's upright brooms are **designed for extended use and offer superior performance.** Whether you're sweeping a lobby, kitchen floor or parking lot, we have **a high quality solution for you.**



Duo-Sweep® Angled

- For reaching into corners, along walls and into hard to reach areas
- Block made with tough & durable material that resists cracking, splitting, chipping
- Color coded angle brooms have one handle hole making them more hygienic and HAACP compliant
- Standard color (00) angle brooms have two handle holes; one angled, one upright

Recycled Angle Broom

- Contains 80% recycled flagged PET bristles and 60% recycled polypropylene copolymer shroud for increased stability
- Includes 48" durable vinyl coated metal handle with swivel hanging cap for storage

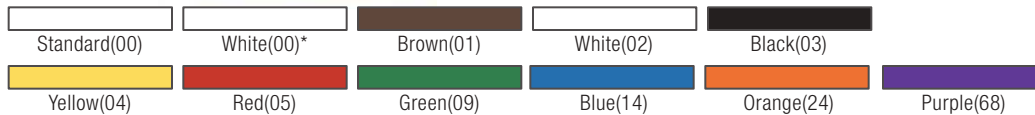

Prod No	Description	Bristle Length	Color	Pack
Flagged Duo-Sweep Angle Brooms				
36861	6.5" Flagged Duo-Sweep Angle Broom with 30" Metal Handle	5.5" - 7"	00	12 ea
36865	12" Flagged Duo-Sweep Medium Duty Angle Broom with 48" Metal Handle	5.5" - 7"	00	12 ea
41082	12" Flagged Duo-Sweep Broom with 48" Fiberglass Handle	5.5" - 7"	01, 02, 04, 05, 09, 14, 24, 68	12 ea
36867	12" Flagged Duo-Sweep Angle Broom – (Head Only)	5.5" - 7"	00, 01, 02, 04, 05, 09, 14, 24	12 ea
Unflagged Duo-Sweep Angle Brooms				
36885	12" Unflagged Duo-Sweep Heavy Duty Angle Broom with 48" Metal Handle	5.5" - 7"	00	12 ea
41083	12" Unflagged Duo-Sweep Broom with 48" Fiberglass Handle	5.5" - 7"	01, 02, 04, 05, 09, 14, 24, 68	12 ea
36868	12" Unflagged Duo-Sweep 12" Angle Broom (Head Only)	5.5" - 7"	01, 02, 03, 04, 05, 09, 14	12 ea
Replacement Handles				
41225	48" Fiberglass Handle with Self-Locking Flex™ Tip – 1" D	—	00*, 01, 03, 04, 05, 09, 14	12 ea
3620294	48" Plastic Coated Metal Threaded Handle – 15/16" D	—	03	12 ea
3620194	48" Powder Coated Metal Threaded Handle – 7/8" D	—	14	12ea
Recycled Angle Broom				
40650	12" Flagged Recycled Angle Broom with 48" Steel Handle	6" - 7"	00	12 ea



Flagged

Great for fine debris and use on smooth surfaces



Unflagged

Great for larger debris and rough surfaces: Bristles prevent ends from matting making this style perfect for back-of-house and outdoor applications

Duo-Sweep® Straight

- Two handle holes; upright hole for general purpose sweeping or angle hole for reaching into corners, along walls, or into hard to reach areas
- Flagged blue synthetic bristle for fine debris
- Stiff black synthetic bristles can be easily cleaned to extend broom life
- Guaranteed to outlast up to four corn brooms



Prod No	Description	Bristle Length	Color	Pack
Flagged Duo-Sweep Brooms				
36859	7.5" Flagged Duo-Sweep Lobby Broom with 30" Black Metal Handle	4"	14	12 ea
36863	11" Flagged Duo-Sweep Light Industrial Broom with 48" Blue Metal Handle	4"	14	12 ea
36853	11" Flagged Duo-Sweep Light Industrial Broom (Head Only)	4"	14	12 ea
36883	13" Flagged Duo-Sweep Warehouse Broom with 48" Blue Metal Handle	7"	14	12 ea
36873	13" Flagged Duo-Sweep Warehouse Broom (Head Only)	7"	14	12 ea
Unflagged Duo-Sweep Brooms				
36860	7.5" Unflagged Duo-Sweep Lobby Broom with 30" Black Metal Handle	4"	03	12 ea
36864	11" Unflagged Duo-Sweep Light Industrial Broom with 48" Blue Metal Handle	4"	03	12 ea
36854	11" Unflagged Duo-Sweep Light Industrial Broom (Head Only)	4"	03	12 ea
36884	13" Unflagged Duo-Sweep Warehouse Broom with 48" Black Metal Handle	7"	03	12 ea
36874	13" Unflagged Duo-Sweep Warehouse Broom (Head Only)	7"	03	12 ea
Replacement Handles				
41225	48" Fiberglass Handle with Self-Locking Flex™ Tip – 1" D	—	00*, 03, 04, 05, 09, 14	12 ea
3620294	48" Plastic Coated Metal Threaded Handle – 15/16" D	—	03	12 ea
3620194	48" Powder Coated Metal Threaded Handle – 7/8" D	—	14	12ea

UPRIGHT BROOMS

Natural Corn Blend

- Heavy-duty lacquered wood handle
- 41354 heavy-duty warehouse broom has metal retaining bands and strong synthetic stitching for long-lasting use
- 41350 janitor broom has wide fan head for greater reach



100% Natural Corn

- Long lasting, durable broomcorn
- Heavy-duty lacquered wood handle



Prod No	Description	Stitch	Color	Pack
Natural Corn Blend Brooms				
36633	10" Corn Whisk	2-Sew	00	12 ea
3682	40" Corn Lobby Broom	3-Sew	00	12 ea
41349	55" Housekeeping Broom	3-Sew	67	12 ea
41352	55" Housekeeping Broom	4-Sew	00	12 ea
41350	56" Janitor Broom	5-Sew	67	12 ea
41354	56" Heavy Duty Warehouse Broom	4-Sew/1-Wire	67	12 ea
100% Natural Corn Broom				
40634	56" Janitor Broom	5-Sew	00	6 ea

Synthetic Corn

- “X” shaped polypropylene bristles allow for superior sweeping on carpeting and entry mats
- Chemical and liquid resistant bristles; sustains temperatures to 225°F
- All, except 36634, have wooden handle
- 41679 has a foam gripped handle
- 45643 and 45649 have metal top for added durability



Prod No	Description	Stitch	Color	Pack	Cs Wt/Cube
Synthetic Corn Brooms					
41679	57" Warehouse/Janitor Broom	6-Sew	03	12 ea	23.75/3.85
41680	55" Housekeeping Broom	5-Sew	03	12 ea	25.75/4.76
45649	54" Housekeeping Broom with Metal Top	Wire/Metal Top	01	6 ea	17.30/1.61
45643	48" Maid Broom with Metal Top	Wire/Metal Top	04	12 ea	18.86/3.44
41683	40" Toy/Lobby Broom	3-Sew	03	12 ea	10.25/1.21
36634	9" Plastic Corn Whisk	2-Sew	00	12 ea	3.96/1.34

FLOOR SWEEPS

Only Carlisle offers a broad range of high quality professional floor sweeps that are durable and versatile.

Our manufacturing and industry expertise provides advantageous features you can't find elsewhere.

Omni Sweep®

- Unique patented design combines the features of fine, medium, and heavy floor sweeps in a convenient all-in-one design
- Effective on all types of floor surfaces
- Short, heavy bristles in front easily sweep up heavy debris
- Long, fine/medium bristles in back sweep fine dust and particles



Angled Pitch

Fast, effective sweeping



41881 with 40225 Handle

41880 with 40225 Handle

Sweep Complete™

- Versatile and durable floor sweep with built-in squeegee
- Comes with 60", 3-piece aluminum handle with brace
- Two handle holes extend the life of the sweep



36219618

Handles sold separately; see pages 306-307 for handle recommendation



Prod No	Description	Bristle Length	Handle	Color	Pack
Omni Sweep – Plastic Block					
41880	18" Omni Sweep	1.63" - 2.38"	Threaded	00	12 ea
41881	24" Omni Sweep	1.63" - 2.38"	Threaded	00	12 ea
Sweep Complete Floor Sweeps					
36219618	18" Sweep Complete Floor Sweep with Squeegee	3"	Threaded	14	6 ea
36219624	24" Sweep Complete Floor Sweep with Squeegee	3"	Threaded	14	6 ea

Fine

- Recommended use: Fine powder and dust removal on polished wood, marble, terrazzo, or ceramic tile floors
- Heavy-duty plastic block resists splitting and cracking and is unaffected by moisture
- Soft, flagged bristles



36204824

Medium

- Recommended use: For general sweeping of smooth concrete, unpolished wood, vinyl and tile floors
- Heavy-duty plastic blocks resist splitting and cracking and are unaffected by moisture
- Horsehair-Polypropylene is a perfect blend of soft bristles for fine dust and stiff bristles for heavier debris
- Use black natural tampico bristles for heavy dirt
- Black polypropylene bristles resist oil and water while maintaining shape



40562

Handles sold separately; see pages 306-307 for handle recommendation



Prod No	Description	Handle	Color	Pack
Fine Floor Sweeps				
36204818	18" Foam Block with Gray Polypropylene, 3" trim	Tapered	23	12 ea
36204824	24" Foam Block with Gray Polypropylene, 3" trim	Tapered	23	12 ea
Medium Floor Sweeps				
40564	18" Foam Block with Black Tampico, 3" trim	Tapered	00	12 ea
40565	24" Foam Block with Black Tampico, 3" trim	Tapered	00	12 ea
40561	18" Foam Block with Horsehair-Polypropylene Blend, 3" trim	Tapered	00	12 ea
40562	24" Foam Block with Horsehair-Polypropylene Blend, 3" trim	Tapered	00	12 ea
362208P18	18" Foam Block with Black Polypropylene, 3" trim	Tapered	03	12 ea
362208P24	24" Foam Block with Black Polypropylene, 3" trim	Tapered	03	12 ea

FLOOR SWEEPS

Heavy

- Recommended Use: Outdoors on rough surfaces such as sidewalks and parking lots
- For wet or dry sweeping
- Polypropylene (PPY) bristles are stiff and long lasting under harsh conditions. PPY bristles resist oil and water making them ideal for back-of-house cleaning
- Palmyra bristles are medium stiff and long lasting under harsh conditions
- Plastic blocks are extremely durable and resist water, cracking, splitting and chipping
- Wood blocks are made with natural lacquered hardwood

Plastic Block



36207218

Wood Block



45222

367624

367618

Handles sold separately; see pages 306-307 for handle recommendation



Prod No	Description	Handle	Color	Pack
Heavy Floor Sweeps				
36207218	18" PPY Sweep, Foam Block, 3.25" trim	Tapered	00	12 ea
36207224	24" PPY Sweep, Foam Block, 3.25" trim	Tapered	00	12 ea
45222	24" Palmyra Sweep with Hardwood Block, 3.5" trim	Threaded/Tapered	00	12 ea
367618	18" PPY Sweep, Hardwood Block, 3.25" trim	Threaded/Tapered	24	12 ea
367624	24" PPY Sweep, Hardwood Block, 3.25" trim	Threaded/Tapered	24	12 ea

DUSTPANS & SWEEPERS

Lobby Pan & Broom Combos

- Lobby pans and brooms with sectional handles to give you over 50% reduction in carton size; lower cube saves warehouse space and shipping costs
- The lobby pans pivot and lock into place during use and release for easy carrying or emptying
- Handles feature a pivoting hanging hole at top for storage

361415 Combo includes the following:

- Serrated edge allows you to comb the broom's bristles and drop debris into the pan
- Handy clip to attach broom for convenient storage
- 30" two-piece handle made from vinyl coated steel

361416 Combo includes the following:

- Adjustable position head for more functional use in corners and under counters or tables
- 3 piece, 30" handle
- Handy clip to attach broom for convenient storage
- Shelf-friendly packaging



Black(03)

Prod No	Description	Material	Style	Color	Pack
Lobby Pan & Broom Combos					
361415	Duo-Pan™ Lobby Pan & Duo-Sweep Broom Combo	Plastic	Lobby	03	1 ea
361412	Broom Handle Clip for 361415	—	—	03	12 ea
361416	Duo-Pan™ II Lobby Pan & Broom Combo	Plastic	Lobby	03	4 ea

DUSTPANS & SWEEPERS

Dust & Lobby Pans

- Dust Pans are available in metal or plastic as well as in a “flip-up” lobby style or hand held
- Dust pan (361437) features a 90° threaded handle hole to convert it to an economy lobby dustpan
- 361420 features a 2 piece handle which reduces the carton size saving warehouse space and shipping costs
- 361420 has plastic edged teeth on the bail which allows you to comb through broom bristles to remove debris



Floor Sweepers

- Brushless mechanical sweeper has non-marking rubber blades that grab fine particles and heavy debris from various types of floor surfaces
- Large capacity dust bins thoroughly clean blades as they rotate; won't re-deposit dirt like ordinary sweepers
- Easy one touch doors for emptying debris
- Shelf-friendly packaging



Prod No	Description	Material	Style	Color	Pack
Dust & Lobby Pans					
361420	12" Wide Lobby Dust Pan with 2-Piece 30" Handle	—	Lobby	03	1 ea
361437	12" Wide Rubberized Plastic Dustpan	Plastic	Hand-Held	03	24 ea
36236	12" Metal Dustpan	Heavy Gauge Steel	Hand-Held	03	12 ea
361410	12" Duo-Pan™ Plastic Lobby Pan with 30" Metal Handle	Plastic	Lobby	03	6 ea
36141003-1	12" Duo-Pan™ Plastic Lobby Pan with 30" Metal Handle	Plastic	Lobby	—	1 ea
Floor Sweepers					
36399	9.5" Multi-Surface Sweeper	—	—	14	4 ea
36400	12" Multi-Surface Sweeper	—	—	14	4 ea

FLOOR SCRUB BRUSHES

Dual Surface Brushes

- Recommended use: Cleaning kitchen floors, under counters, around equipment, and along baseboards
- Floor scrubs are made with three different brush surfaces for cleaning at different angles
- Non-absorbent plastic blocks and synthetic bristles wash easily and prevent gathering of mold and mildew



Scrub Brushes

- Recommended use: Cleaning kitchen floors, under counters, around equipment, and along baseboards
- Polypropylene (PPY) bristles are stiff and long lasting under harsh conditions. PPY bristles resist oil and water making them ideal for back-of-house cleaning
- Tampico bristles provide durability and high resistance to solvents and heat
- Palmyra bristles are medium stiff and long lasting under harsh conditions
- Natural wood block



Handles sold separately; see pages 306-307 for handle recommendation

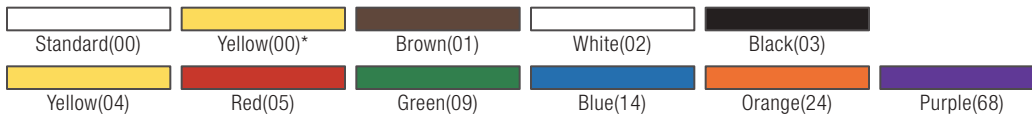

Prod No	Description	Handle	Color	Pack
Dual Surface Brushes				
40423	10" Hi-Lo Floor Scrub Brush	Threaded	01, 02, 03, 04, 05, 09, 24, 68	12 ea
36197	10" Dual Surface Scrub Brush	Threaded	14	12 ea
36190	10" Dual Surface Scrub Brush with Squeegee	Threaded	14	12 ea
40422	10" Dual Surface Scrub Brush with End Bristles	Threaded	00*, 05, 09, 14	12 ea
Floor & Deck Scrub Brushes				
36175	10" Wood Block with Stiff Polypropylene Bristles	Threaded/Tapered	14	12 ea
36275	12" Wood Block with Stiff Polypropylene Bristles	Threaded/Tapered	14	12 ea
36193	10" Wood Block with Tampico Bristles	Threaded/Tapered	00	12 ea
36192	10" Wood Block with Palmyra Bristles	Threaded/Tapered	00	12 ea
36292	12" Wood Block with Palmyra Bristles	Threaded/Tapered	00	12 ea

FLOOR SCRUB BRUSHES

Swivel Floor Brushes

- Patented* design swivels onto side to clean baseboards, walls, around kitchen equipment, and other hard to reach areas

*U.S. Patent No. 4763377



36219663



365300



365310



40430

Scrub Pads & Holder

- Swivel pad holder is great for cleaning baseboards, floor edges, underneath fixtures and ceramic tile



365380 Pad Holder
w/40724 Scrubber Pad



40724

40725

Handles sold separately; see pages 306-307 for handle recommendation



Prod No	Description	Handle	Color	Pack
Swivel Floor Brushes				
365300*	8" Heavy-Duty Daily Swivel Scrub with Nylon Grit Bristles	Threaded	14	12 ea
365310*	8" Swivel Scrub with Heavy Nylon Grit Bristles	Threaded	27	12 ea
40430	9" All-Around Scrub Brush with Stiff Polypropylene Bristles	Threaded	00*	12 ea
36219663	8" Polypropylene-Fill Swivel Scrub with 48" Handle	—	00	4 ea
Scrub Pads & Holder				
40724	10" x 4-5/8" x 1" Nylon Fine Scrub Pad, 5 ea/pack, 4 pks/case	—	00	4 pks
40725	10" x 4-5/8" x 1" Nylon Medium Scrub Pad, 5 ea/pack, 4 pks/case	—	00	4 pks
365380	Swivel Pad Holder	—	14	12 ea

GROUT BRUSHES & FLOOR SQUEEGEES

Tile & Grout Brushes

- 365320 has bevel cut stiff crimped nylon bristles and a swivel head for hard to reach areas
- 41323 features a molded in scraper for tough dirt and grime and can be hand held or used with a threaded handle. Base resins for block and bristles are FDA compliant



Double Foam Squeegees with Metal Frame

- Rugged black neoprene for heavy-duty removal of dirt, water and debris on uneven surfaces
- Medium flexibility and non-marking

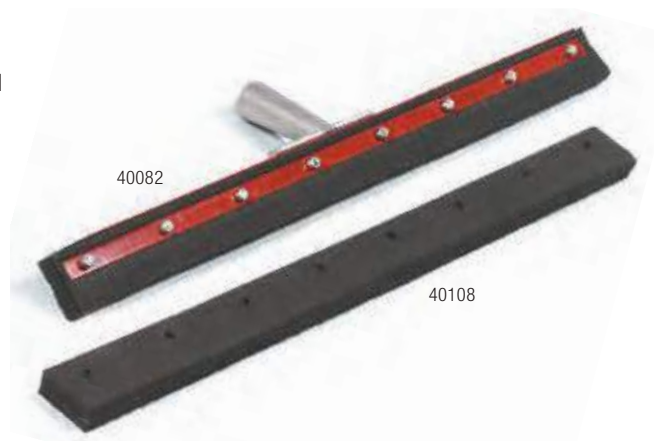

Handles sold separately; see pages 306-307 for handle recommendation

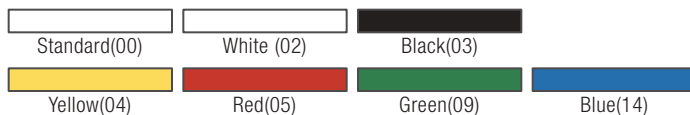

Prod No	Description	Handle	Color	Pack
Tile & Grout Brushes				
365320	7.5" Swivel Head Grout Line Brush, Nylon Bristle	Threaded/Tapered	03	12 ea
365351	8.5" Grout Brush, Nylon Bristle	—	03	24 ea
41323	9" Tile & Grout Brush	Threaded	02, 04, 05, 09, 14	12 ea
Double Foam Squeegees with Metal Frame				
40081	18" Double Foam Neoprene Rubber	1.13" Tapered	00	6 ea
40082	24" Double Foam Neoprene Rubber	1.13" Tapered	00	6 ea
40083	30" Double Foam Neoprene Rubber	1.13" Tapered	00	6 ea
40107	18" Double Foam Neoprene Rubber Refill	—	00	12 ea
40108	24" Double Foam Neoprene Rubber Refill	—	00	12 ea
40109	30" Double Foam Neoprene Rubber Refill	—	00	12 ea

FLOOR SQUEEGEES

Double Moss Foam Rubber with Metal Frame

- Moss Foam squeegee is designed for uneven, grouted and smooth surface floors
- Red Moss Foam is fat and oil resistant



Double Foam Rubber Squeegee with Plastic Frame

- All plastic construction will not rust or bend and helps prevent hazard sparks when cleaning-up flammable fluids
- Available in colors to support HACCP compliance
- For uneven or smooth surfaces



Double Moss Foam Rubber Squeegee with Plastic Frame

- Soft, double foam is fat and oil resistant
- All plastic construction will not rust or bend and helps prevent hazard sparks when cleaning-up flammable fluids
- For uneven or smooth surfaces



Handles sold separately; see pages 306-307 for handle recommendation

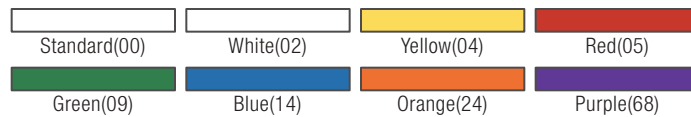

Prod No	Description	Handle	Color	Pack
Double Moss Foam Rubber with Metal Frame				
366318	18" Soft Black Foam Rubber	.94" Tapered	00	10 ea
366324	22" Soft Black Foam Rubber	.94" Tapered	00	10 ea
366824	22" Soft Black Heavy-Duty Foam Rubber	Threaded	00	10 ea
366330	30" Reinforced Soft Black Foam Rubber	.94" Tapered	00	10 ea
Double Foam Rubber Squeegee with Plastic Frame				
41567	18" Double Foam Rubber Floor Squeegee	Threaded	02, 04, 05, 09, 14, 24, 68	6 ea
41568	24" Double Foam Rubber Floor Squeegee	Threaded	02, 04, 05, 09, 14, 24, 68	6 ea
Double Moss Foam Rubber Squeegee with Plastic Frame				
366918	18" Red Foam Rubber	.94" Threaded	00	10 ea
366922	22" Red Foam Rubber	.94" Threaded	00	10 ea

Double Foam Rubber Squeegee & Brush with Plastic Frame

- Use the brush side to remove stubborn debris and the squeegee side to dry the floor
- All plastic construction will not rust or bend and helps prevent hazard sparks when cleaning-up flammable fluids



Curved End Rubber Squeegee with Metal Frame

- Single rubber blade design
- Curved end controls liquid better
- For smooth surfaces
- Red gum rubber is non-marking and durable for heavy-duty use



One-Piece Rubber Squeegee with Plastic Frame

- All plastic construction will not rust or bend and helps prevent hazard sparks when cleaning-up flammable fluids
- Available in colors to support HACCP compliance
- For smooth surfaces



Handles sold separately; see pages 306-307 for handle recommendation

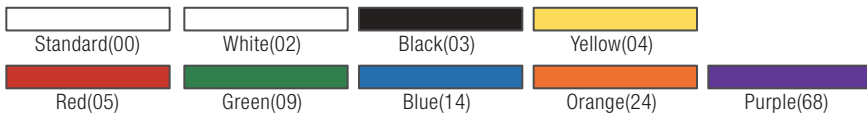

Prod No	Description	Handle	Color	Pack
Double Foam Rubber/Brush with Plastic Frame				
367818	18" Red Double Foam Red Rubber	Threaded	00	10 ea
Single Curved End Rubber Squeegee with Metal Frame				
36324C	24" Curved End Black Rubber Squeegee	1.13" Tapered	00	6 ea
36336C	36" Curved End Black Rubber Squeegee	1.13" Tapered	00	6 ea
One-Piece Rubber Squeegee with Plastic Frame				
36567	20" Solid, One-Piece Rubber Squeegee	Threaded	02, 03, 04, 05, 09, 14, 24, 68	6 ea
36568	24" Solid, One-Piece Rubber Squeegee	Threaded	02, 03, 04, 05, 09, 14, 24, 68	6 ea

FLOOR SQUEEGEES

Straight Rubber Squeegee with Metal Frame

- Durable construction
- Non-marking single red gum rubber blade with medium flexibility
- Heavy duty steel frame with red powder coating



40076

VersaClean™ Brush & Squeegee

- It's a broom, scrub brush and squeegee all in one! Can be used on wet or dry surfaces
- Unique non-marking synthetic rubber bristles can build electrostatic charge to pick up hair or other light debris from soft or hard floor surfaces
- Durable bristles are excellent for scrubbing
- Dishwasher safe making it one of the most hygienic broom and brush options on the market
- Resists most chemicals and withstands temperatures up to 212°F



36596

36592



Squeegee cleans up wet surfaces quickly



Picks up light debris from carpet, rugs, or bare floors



Use as an agitator for stubborn spots on tile or concrete



Built-in one-piece squeegee works on rough concrete surface

Handles sold separately; see pages 306-307 for handle recommendation

Standard(00)

Prod No	Description	Handle	Color	Pack
Single Straight Rubber Squeegee with Metal Frame				
40075	18" Straight Red Gum Squeegee	1.13" Tapered	00	6 ea
40076	24" Straight Red Gum Squeegee	1.13" Tapered	00	6 ea
40077	36" Straight Red Gum Squeegee	1.13" Tapered	00	6 ea
VersaClean Brush & Squeegee				
36592	VersaClean Brush with Squeegee	Threaded	03	12 ea
36596	VersaClean Brush with Squeegee	Threaded	03	12 ea

HANDLES

Carlisle offers a large selection of professional quality handles that include fiberglass, plastic, metal, hardwood, and telescoping.

Color-Coded Fiberglass Handles

- Durable for heavy usage
- For use with push brooms, sweeps, squeegees, and floor scrubs
- Fiberglass handles are available in threaded, tapered/threaded and telescoping
- Self-Locking Flex-Tip Handle offers greater flexibility and reduces handle stress

Plastic Handles

- A variety of sizes with reinforced threaded tip
- For light usage



Prod No	Description	Dia	Style	Color	Pack
Color-Coded Fiberglass Handles					
41226	72" Fiberglass Handle with Self-Locking Flex-Tip	1"	Threaded	00	12 ea
41225	48" Fiberglass Handle with Self-Locking Flex-Tip	1"	Threaded	00, 04, 05, 09, 14	12 ea
41291	36" Fiberglass Handle with Self-Locking Flex-Tip	1"	Threaded	00	12 ea
40225	60" Fiberglass Handle with Self-Locking Flex-Tip	1"	Threaded	01, 02, 03, 04, 05, 09, 14, 24, 25, 68	12 ea
40227	60" Solid Foam Filled Fiberglass Handle with Self-Locking Flex-Tip	1"	Tapered/Threaded	02, 04, 05, 09, 14	12 ea
40220	60" Fiberglass Handle	1"	Tapered/Threaded	01, 02, 04, 05, 09, 14	12 ea
40210	60" Economy Fiberglass Handle	.94"	Female Threaded	02, 04, 05, 09, 14	12 ea
41020	54" to 8' Threaded Telescoping Fiberglass Handle	1"	Threaded Telescoping	01, 02, 04, 05, 09, 14	12 ea
Plastic Handles					
40230	36" Plastic Handle with Reinforced Tip	1"	Threaded	00	12 ea
40233	48" Plastic Handle with Reinforced Tip	1"	Threaded	00	12 ea
40232	60" Plastic Handle with Reinforced Tip	1"	Threaded	00	12 ea

FIBERGLASS

PLASTIC



HANDLES

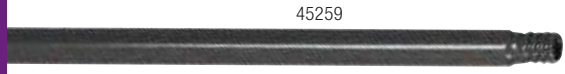

45259

STEEL



3620194

METAL

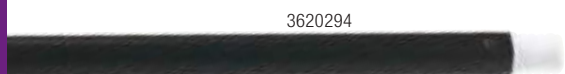

3620294



365408

TELESCOPIC



41020

Steel Handles

- Heavy-duty stainless steel handles are highly chemical resistant
- For use with caustic chemicals or in a sanitary food processing environment
- Highly durable alternative to fiberglass

Coated Metal Handles

- Lightweight and economical
- Plastic hanging cap

Telescopic Handles

- Adjusts quickly to desired length
- Standard threaded end
- Ideal for window brushes and squeegees

3-Piece Aluminum Handle

- Utilizes metal y-connectors to secure sections
- Compact size saves on shipping costs
- Shelf-ready packaging



40224

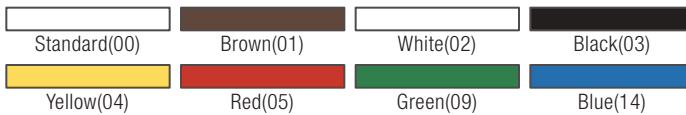

Prod No	Description	Dia	Style	Color	Pack
Steel Handles					
45259	60" Steel Handle	.94"	Threaded	00	12 ea
Coated Metal Handles					
3620194	48" Light Weight Powder Coated Metal Handle with Plastic Tip	.88"	Threaded	14	12 ea
3620294	48" Plastic Coated Metal Handle	.94"	Threaded	03	12 ea
Telescopic Handles					
365408	54" to 8' Aluminum Telescopic Handle with Locking Joints	1"	European Tapered/ Standard Threaded	00	10 ea
41020	54" to 8' Fiberglass Telescopic Handle	1"	Threaded	01, 02, 04, 05, 09, 14	12 ea
3-Piece Aluminum Handle					
40224	60" 3-Piece Aluminum Handle with Standard Thread	1"	Threaded	00	12 ea

Wood Handles

- Made of lacquered hardwood
- Available in a large selection of standard threaded and tapered styles, along with our Anchor™ Style
- Economical choice

WOOD



Dust Mop Handles

- Available in wood, coated metal and fiberglass
- 360° movement for fast and easy cleaning

DUST MOP

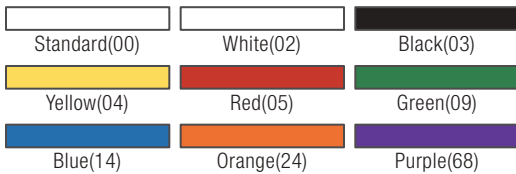

Prod No	Description	Dia	Style	Color	Pack
Wood Threaded Handles					
40271	60" Wood Handle	.94"	Threaded	00	12 ea
40267	60" Wood Handle	1.13"	Threaded	00	12 ea
Metal Threaded Handles					
40275	40" Metal Tip Wood Handle	.88"	Metal Thread	00	12 ea
45267	60" Wood Handle with Metal Tip	.94"	Metal Thread	00	12 ea
Tapered Handles					
40261	54" Wood Handle	1.13"	Tapered	00	12 ea
40262	60" Wood Handle	1.13"	Tapered	00	12 ea
Dust Mop Handles					
45850	60" Wood Dust Mop Handle with Clip-On Connector	.94"	—	00	12 ea
362013	60" Vinyl Coated Metal Dust Mop Handle with Clip-On Connector	.94"	—	00	12 ea
Fiberglass Dust Mop Handles					
362113	60" Fiberglass Dust Mop Handle	1"	—	02, 03, 04, 05, 09, 14, 24, 68	12 ea

HANDLE ACCESSORIES

Roll 'N Grip™ Broom & Brush Holder System

- Adjustable rack holds a variety of different handle diameters
- Comes with a convenient hook for tools and brushes (additional hooks and grippers are available by special order)
- Rack anchor holes are 16" on center (mounting screws included)



Roll 'N Grip Plus

- Constructed of light-weight, durable ABS and rubber
- Fold-up hanging hooks for smaller items
- For use in temperatures from -4°F to 176°F
- Grips accommodate items from 5/8" - 1-1/4" in diameter and 0.4 - 8.25 lbs
- Hanging hooks can hold up to 1.5 lbs each



Color-Coded Brush Rack

- Heavy-gauge aluminum
- Extra deep (2-1/4") frame extends out from wall to allow brushes to hang with bristles facing the wall
- Holds up to 10 hanging tools
- Mounting holes are 16" on center (mounting screws included)
- Available in 5 colors to support HACCP compliance

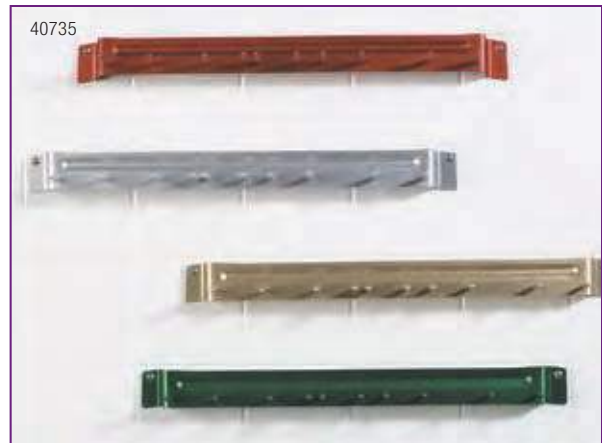

Prod No	Description	Color	Pack
Roll 'N Grip Broom & Brush Holder System			
40731	18" Roll 'N Grip Broom & Brush Holder System	00	12 ea
40732	Roll 'N Grip Replacement Roller (2 per pack) with 4 Wood Screws	00	12 pk
40733	Roll 'N Grip Replacement Hooks (2 per pack) with 4 Wood Screws	00	12 pk
Roll 'N Grip Plus			
40737	16-1/2" Roll 'N Grip Plus Broom & Brush Holder	00	24 ea
Color-Coded Brush Rack			
40735	17" Brush Rack	00*, 04, 05, 09, 14	12 ea

MICROFIBER SYSTEM & DUST MOPS

Microfiber Dry Mop

- Looped end with microfiber center clings to dust like a magnet
- Quickly attaches itself to aluminum head
- Machine washable



Microfiber Wet Mop

- Dries quicker, cleans more thoroughly than a standard mop
- Machine washable and still effective with over 500 washings
- Quickly attaches itself to aluminum head



Aluminum Flat Mop Heads & Telescoping Handle For Microfiber

Mop Heads

- Heavy duty construction and swivel mechanism
- For use with wet and dry microfiber flat mops

Handle

- 70" telescopic handle for use with Aluminum flat mop heads



Handles sold separately; see pages 306-307 for handle recommendation



Prod No	Description	Handle	Color	Pack
Microfiber Dry Mops				
3633118	18" Microfiber Dry Mop Pad	—	14	12 ea
3633124	24" Microfiber Dry Mop Pad	—	14	12 ea
3633136	36" Microfiber Dry Mop Pad	—	14	12 ea
Microfiber Wet Mops				
3633218	18" Microfiber Wet Mop Pad	—	05, 09, 14	12 ea
3633224	24" Microfiber Wet Mop Pad	—	14	12 ea
Aluminum Flat Mop Heads				
3633519	18" Aluminum Flat Mop Head	3633670	00	12 ea
3633525	24" Aluminum Flat Mop Head	3633670	00	12 ea
3633537	36" Aluminum Flat Mop Head	3633670	00	12 ea
Telescoping Handle				
3633670	70" Aluminum Telescopic Handle	—	00	12 ea

MICROFIBER SYSTEM & DUST MOPS

Microfiber Charging Bucket

- Rectangular bucket with 6 gallon capacity
- Includes snap-on lid and clip-on plastic sleeve for window washers and squeegees
- Molded-in graduations
- Ergonomic handle for easy transportation



3633019

Tie Back Dust Mops & Frames

- An economical choice for a cotton dust mop with full tie back
- Frame is constructed of heavy gauge metal
- Zinc plating reduces rust and corrosion



3647524

41672

Wedge Dust Mop

- Cotton dust mop with frame
- Threaded handle hole
- For hard-to-reach areas



36490

Handles sold separately; see pages 306-307 for handle recommendation



Prod No	Description	Handle	Color	Pack
Rectangular Microfiber Bucket				
3633019	6 gal Rectangular Microfiber Bucket	—	23	3 ea
Value Line Tie Back Dust Mops				
3647524	24" Dust Mop, Fits 5" Wide Frame	—	00	12 ea
3647536	36" Dust Mop, Fits 5" Wide Frame	—	00	12 ea
3647548	48" Dust Mop, Fits 5" Wide Frame	—	00	12 ea
Wedge Dust Mop				
36490	Wedge Dust Mop	Threaded	00	12 ea
36490R	Wedge Mop Replacement	Threaded	00	12 ea
Dust Mop Frames				
41672	24" Mop Frame, 5" Wide	Clip-On/Flexible	00	12 ea
41673	36" Mop Frame, 5" Wide	Clip-On/Flexible	00	12 ea
3647248	48" Mop Frame, 5" Wide	Clip-On/Flexible	00	12 ea

WET MOPPING GUIDE

Use the guide below to help choose the right products for your floor care needs.

General Mopping

Choose mops with high absorbency, release and durability. If laundering facilities are available, it is beneficial to take advantage of launderable mops to save money. For performance and durability choose a synthetic blend or rayon mop with looped end and woven tailbands.

Yarn

- It is important to choose the right mop in order to get maximum efficiency
- Some yarns naturally perform specific cleaning tasks better than others

Yarn Ply

- Yarn ply is the number of strands twisted together to make a single yarn strand
- Although more plies give added strength, it does not always mean higher quality yarn
- More strands can add durability, but they decrease absorbency
- It is better & more cost effective to choose a higher quality yarn than a high ply, low quality yarn

Twist

- The “twist” of a yarn is a result of how tightly the fiber strands are wound together
- A tightly twisted yarn might have more strength & last longer, but it can have less absorbency
- The best choice is determined by the type & quality of the yarn, as well as the mop’s construction
- Mops with looped-end construction allow the yarn to have a loose twist without the fraying

Finish Mopping

For finish mopping applications look for a rayon or synthetic mop. These mops offer high absorbency and release. To make sure you are achieving maximum floor coverage with minimal streaking choose a tailband and looped end yarn.

	Advantages	Disadvantages	Use
Cotton	Good absorption & retention with limited shrinkage & a low initial cost.	Break-in period required. Slow drying yarn leads to mildew & deterioration. Lints.	Designed for general use. Scrubbing & cleaning up liquids.
Synthetic	Long stable fiber offers excellent tensile strength without linting.	Higher cost. Poor absorption.	Rough surfaces.
Cotton Synthetic Blend	Excellent choice for performance, price & durability. Synthetic fiber offers durability & color options.	Possible shrinkage.	Requested by professionals who require a better, longer lasting mop.
Rayon	Absorbs quickly with easy release. Dries fast & is mildew resistant. Cleaner yarn with less linting.	Shrinks when laundered and has less liquid retention.	Use for applying liquids such as disinfectant or floor finishes.



Band Styles



Wide Band
Vinyl coated mesh. 5" Width



Narrow Band
Textured polyester tape. 1.25" Width



Screw Top
Textured polyester tape with a metal screw on attachment. 1.25" Width

Handle — Jaw Style



Handle — Quick Change/Release



Handle — Screw In



Cut-End Or Looped-End



Cut-End

- Cut-end mops are the most popular
- Low purchase price compared to looped end
- Cannot be laundered
- Cover less area per pass when mopping

Looped-End

- Superior performance & lasts longer than cut-end mops
- Launderable
- Tailband style gives better mopping coverage
- Looped-ends prevent fraying & unraveling so you can achieve reduced labor costs & replace mops less often
- Although the initial investment is more than a cut-end style, the life expectancy makes looped-end mops a more economical choice

How We Rate Our Mops

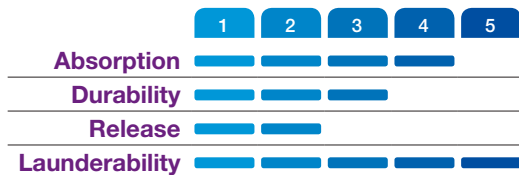

Absorbency

The absorbency of a mop refers to the ability to pick up and retain liquid. Higher levels allow faster floor drying times, leading to greater productivity and safety. Rayon and cotton yarns have the highest absorbency.

Durability

Mop durability is a measure of how long it will last or perform before needing replacement. Synthetic and blended mops are the most durable.

Release/Retention

Release is the ability of a mop to disperse liquid onto the floor or during wringing. Higher levels allow faster and more complete wringing, as well as more efficient application of cleaning solutions on the floor.

Launderability

The launderability is based on the number of washing cycles it can withstand before the construction of the mop is degraded. Synthetic and blended fiber mops have the highest levels of launderability.

Sizes Are Indicated By Tailband Color

Small



Medium



Large



X-Large



Brick Packs

Mops that are available in brick packs reduce cube up to 62%

(Item #'s ending with a "B" are sold in brick packs)



LOOPED END MOPS

Synthetic/Cotton Blend Looped-End

- Maximum Durability
- 50-75 uses per mop
- S, M, and L are available in brick packs

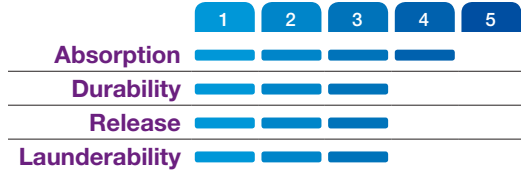

4 Ply Cotton Looped-End

- All purpose for general cleaning
- Packaged in brick packs

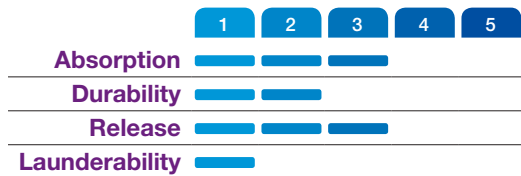

Handles sold separately; see pages 306-307 for handle recommendation



Prod No	Description	Handle	Color	Pack
Synthetic/Cotton Blend (Wide Band)				
369412B	Small Yellow Wide Band Mop with White Yarn	Jaw Style	00	12 ea
369442B	Small Yellow Wide Band Mop with Blue Yarn	Jaw Style	14	12 ea
369472B	Small Yellow Wide Band Mop with Green Yarn	Jaw Style	09	12 ea
369418B	Medium Green Wide Band Mop with White Yarn	Jaw Style	00	12 ea
369448B	Medium Green Wide Band Mop with Blue Yarn	Jaw Style	14	12 ea
369478B	Medium Green Wide Band Mop with Green Yarn	Jaw Style	09	12 ea
369424B	Large Red Wide Band Mop with White Yarn	Jaw Style	00	12 ea
369454B	Large Red Wide Band Mop with Blue Yarn	Jaw Style	14	12 ea
369484B	Large Red Wide Band Mop with Green Yarn	Jaw Style	09	12 ea
369430	X-Large Blue Wide Band Mop with White Yarn	Jaw Style	00	12 ea
369460	X-Large Blue Wide Band Mop with Blue Yarn	Jaw Style	14	12 ea
4-Ply Cotton (Wide Band)				
369550B	Small Yellow Band Looped-End Mop	Jaw Style	00*	12 ea
369551B	Medium Green Band Looped-End Mop	Jaw Style	00*	12 ea
369552B	Large Red Band Looped-End Mop	Jaw Style	00*	12 ea
4 Ply Cotton (Narrow Band)				
369413B	Small Yellow Band Looped-End Mop	Quick Release/Quick Change	00*	12 ea
369419B	Medium Green Band Looped-End Mop	Quick Release/Quick Change	00*	12 ea
369425B	Large Red Band Looped-End Mop	Quick Release/Quick Change	00*	12 ea

LOOPED END & CUT END MOPS

Microfiber Looped-End

- Microfiber mop combines the absorbency and durability of microfiber with conventional mop design and functionality
- Washable mop dries quickly and is still effective with 500 washings
- See pages 291-292 for a complete list of microfiber products

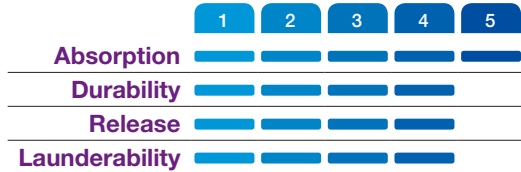

Rough Surface Looped-End

- 17 oz knitted fleece provides twice the absorbency of cotton yarn mops
- Excellent for abrasive surfaces: stone, quarry, tile, and concrete

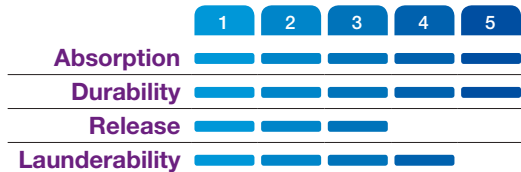

Rayon Blend Finishing Looped-End

- Durable 4-ply rayon blend has narrow band
- Releases liquid faster than a conventional mop for a smoother finish
- Brick packed

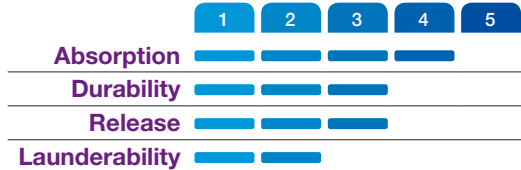

Handles sold separately; see pages 306-307 for handle recommendation



Prod No	Description	Handle	Color	Pack
Microfiber (Wide Band)				
369420	Medium Loop End Microfiber Mop	Jaw Style	02, 14	12 ea
Rough Surface (Narrow Band)				
369320	Medium Looped-End Rough Surface Mop	Quick Release/Quick Change	00	12 ea
4 Ply Rayon Blend Finishing (Wide Band)				
369670B	#20 Medium Finishing Looped-End Mop	Quick Release/Quick Change	14	12 ea
369674B	#24 Large Finishing Looped-End Mop	Quick Release/Quick Change	14	12 ea

4 Ply Cotton Cut-End

- Economical choice for general mopping
- Brick packed

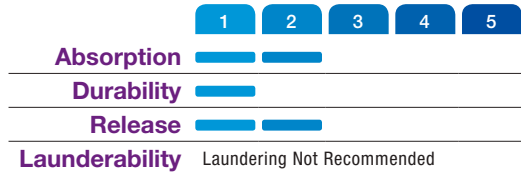

8 Ply Cotton Cut-End

- Abrasion-resistant, long lasting 8 ply cotton
- Best for general purpose cleaning

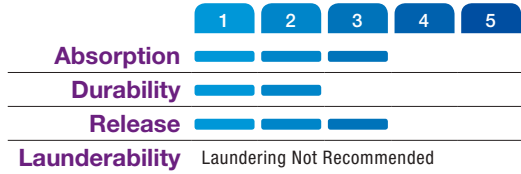

Handles sold separately; see pages 306-307 for handle recommendation



Prod No	Description	Handle	Color	Pack
4 Ply Cotton (Narrow Band)				
369816B	#16 Small Cut-End Mop	Quick Release/Quick Change	00	12 ea
369820B	#20 Medium Cut-End Mop	Quick Release/Quick Change	00	12 ea
369824B	#24 Large Cut-End Mop	Quick Release/Quick Change	00	12 ea
369832	#32 X-Large Cut-End Mop	Quick Release/Quick Change	00	12 ea
4 Ply Cotton (Wide Band)				
369811B	#16 Small Cut-End Mop	Jaw Style	00	12 ea
369814B	#20 Medium Cut-End Mop	Jaw Style	00	12 ea
369817B	#24 Large Cut-End Mop	Jaw Style	00	12 ea
369819B	#32 X-Large Cut-End Mop	Jaw Style	00	12 ea
8-Ply Cotton (Narrow Band)				
369724	#24 Select Cut-End Mop	Quick Release/Quick Change	00	12 ea
369732	#32 Select Cut-End Mop	Quick Release/Quick Change	00	12 ea

CUT END MOPS

4 Ply Rayon Cut End

- Easy to change mop heads lie flat for more efficient mopping
- 40345 Kwik-On wood handle (sold separately) attaches securely to Kwik-On mop head with a counter-sunk, reinforced thread



369074B

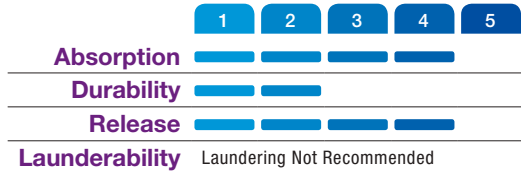

Kwik-On™ Screw Top

- Easy to change mop heads lie flat for more efficient mopping
- 40345 Kwik-On wood handle (sold separately) attaches securely to Kwik-On mop head with a counter-sunk, reinforced thread



369024R

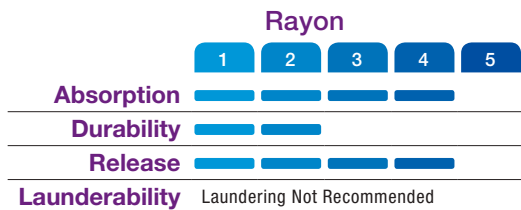
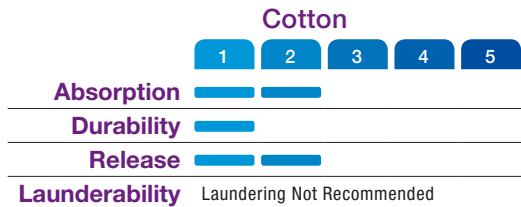

40345

Handles sold separately; see pages 306-307 for handle recommendation

Standard(00)

Prod No	Description	Handle	Color	Pack
4-Ply Rayon (Narrow Band)				
369066B	#16 Small Cut-End Mop	Quick Release/Quick Change	00	12 ea
369070B	#20 Medium Cut-End Mop	Quick Release/Quick Change	00	12 ea
369074B	#24 Large Cut-End Mop	Quick Release/Quick Change	00	12 ea
369082	#32 X-Large Cut-End Mop	Quick Release/Quick Change	00	12 ea
4-Ply Cotton (Kwik-On Screw Top)				
369024C	#24 Kwik-On Cotton Mop	Kwik-On	00	12 ea
4-Ply Rayon (Kwik-On Screw Top)				
369024R	#24 Kwik-On Rayon Mop Head	Kwik-On	00	12 ea
Kwik-On Handle				
40345	60" Kwik-On Handle 1.13" Diameter	—	00	12 ea

SPONGE MOPS & MOP HANDLES

Automatic Sponge Mop

- Recommended for mopping smooth surfaces
- Synthetic sponge head absorbs liquid fast

Ty-Dee™ Sponge Mop

- Recommended for mopping smooth surfaces
- Cellulose sponge head with non-corrosive metal parts and enameled wood handle



Jaw Style Mop Handles

- Use with wide band mops

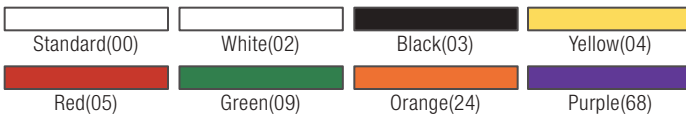

Prod No	Description	Dia	Color	Pack
Automatic Sponge Mops – Aluminum Handle				
40300	8.5" Automatic Sponge Mop	—	00	12 ea
40301	12" Automatic Sponge Mop	—	00	6 ea
40305	8.5" Automatic Sponge Mop Refill	—	00	12 ea
40306	12" Automatic Sponge Mop Refill	—	00	6 ea
Ty-Dee Sponge Mop – Enamel Wood Handle				
36990	9" Ty-Dee Sponge Mop with Built-in Wringer	—	00	12 ea
36990R	9" Ty-Dee Refill	—	00	12 ea
Jaw Style Mop Handles				
369475	60" Fiberglass Mop Handle	1"	00, 02, 03, 04, 05, 09, 24, 68	12 ea
36970	60" Vinyl Coated Metal Mop Handle	.94"	00	12 ea

MOP HANDLES

Quick-Release Mop Handles

- 60" durable fiberglass
- Flexible plastic head with hinged gripper bites into any size mop band
- Releases mop head quickly; employees never need to touch a dirty mop head



41664



369595

Quick Change Handles

- Use with narrow band mops
- Plastic head with thumb wheel clamps mop in place
- Metal heads feature standard wing nut construction with a quick release cross bar



40340



369365



369375



36968

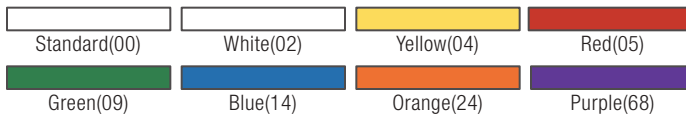

Prod No	Description	Dia	Color	Pack
Color-Coded Quik-Release Mop Handle				
41664	60" Fiberglass Mop Handle	1"	02, 04, 05, 09, 14, 24, 68	12 ea
Quik-Release Handle				
369595	Quik-Release Powder-Coated Metal Handle	—	00	12 ea
Quick Change Handles – Wood				
369365	60" Wood Mop Handle with Plastic Head	1.13"	00	12 ea
40340	63" Wood Mop Handle with Metal Head	1.13"	00	12 ea
Quick Change Handle – Fiberglass				
369375	60" Fiberglass Mop Handle with Plastic Head	1"	00	12 ea
Quick Change Handle – Vinyl Coated Metal				
36968	60" Handle with Plastic Head	1"	00	12 ea

MOP BUCKETS & SIGNS

Bucket & Wringer Combos

- Made of durable, corrosion resistant polyethylene
- Non-marking casters
- Available in 26 or 35 quart sizes
- Individual Side Press Wringer available – fits both 26 quart (36908) and 35 quart (36904) mop buckets



36904



36908W



36905



36908

Wet Floor Signs

- Durable polypropylene
- Specially designed feet protect floor finishes
- 36900 locks into place to prevent collapsing
- Compact for easy storage



36909



36900

Freestanding Caution Cones

- 360° visibility
- Caution message appears in English, Spanish and French



36941



36940

Case for
36942 Pop Up
Caution Cone



36942

Caution Pop Up Cones

- 360° visibility
- Caution message appears in English, Spanish and French
- Case can be mounted to wall for easy access



Prod No	Description	Color	Pack
Mop Buckets			
36908	26 qt Bucket with Side Press Wringer	04, 05, 09, 14, 69	1 ea
36904	35 qt Bucket with Side Press Wringer	04, 05, 09, 14, 69	1 ea
36908W	Side Press Wringer for 26 qt and 35 qt Mop Bucket	04, 05, 09, 14, 69	1 ea
36905	35 qt Bucket with Down Press Wringer	04	1 ea
36908C	3" Swivel Casters for all Mop Buckets	00	2 ea
Folding Wet Floor Signs			
36900	Floor Sign (English/Spanish)	00	6 ea
36909	Economy Wet Floor Sign (English/Spanish/German)	04	6 ea
Caution Cones			
36940	27" Caution Cone	04	3 ea
36941	36" Caution Cone	04	3 ea
36942	20" Pop Up Caution Cone	04	12 ea

FLOOR & RESTROOM MAINTENANCE

Floor Drain Brush

- Long lasting polypropylene bristles and plastic handles stand up to rugged use
- Drain Brush handles (sold separately) are prominently marked in English and Spanish for "floor drain use only" to prevent contact with food and serving utensils
- Available in a variety of sizes



40146

Drain Opener

- Convenient, sanitary way to remove floor drain covers
- Easy to use, simply insert into drain and twist to remove drain cover and drain basket
- One-piece construction with plastic handles for secure grip



40144



Standard(00)
 White(02)

Prod No	Description	Color	Pack
Drain Opener			
40144	Drain Opener	02	12 ea
Floor Drain Brush			
40146	3" Floor Drain Brush	00	6 ea
40147	4" Floor Drain Brush	00	6 ea
41093	5" Floor Drain Brush	00	6 ea
40148	6" Floor Drain Brush	00	6 ea
40236	36" Plastic Drain Brush Handle	00	12 ea
40237	48" Plastic Drain Brush Handle	00	12 ea

Boot 'N Shoe Brush

- Helps eliminate dirt, and other contaminants from being tracked into food prep and serving areas
- Chromed steel tube frame can be bolted to floor for security; brushes flip up to expose a steel scraper
- Non-absorbent plastic block construction with long lasting blue polypropylene bristles



Bowl Brushes

- Bowl brushes are available in a variety of styles and bristle materials
- 40140 has 180° bristle head to prevent splash-back
- 36232 and 36233 have all-natural cotton yarn securely attached to smooth wood handle



Ergonomic Force Cup

- Ergonomic design maximizes applied force while maintaining ease and longevity of use
- Over-molded rubber handle for easy grip
- 21" plastic handle is non-absorbent and more sanitary than wood handles

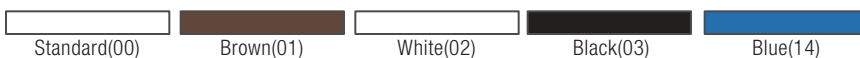

Prod No	Description	Handle Material	Color	Pack
Boot 'N Shoe Brush				
40424	Boot 'N Shoe Brush	—	01, 03, 14	1 ea
40425	Boot 'N Shoe Brush Replacement	—	01, 03, 14	12 ea
Bowl Brushes				
40140	17" No-Splash Polyester Brush	Plastic	00	12 ea
36P5	17" Twist-In-Wire Synthetic Bristle Brush	Plastic	02	24 ea
3633	21" Twist-In-Wire Synthetic Bristle Brush	Plastic	00	24 ea
36232	10" Cotton Bowl Mop	Wood	00	36 ea
36233	20" Cotton Bowl Mop	Wood	00	36 ea
Ergonomic Power Plunger				
36439	Ergonomic Power Plunger	Plastic/Rubber	03	12 ea

HANDLE GUIDE

Prod No	Page	Description	Type of Handle	Recommended Handle
Duo-Sweep Brooms				
36859	275	7" Duo-Sweep Flagged Broom	Threaded	362019414
36863	275	9" Duo-Sweep Flagged Broom	Threaded	362019414
36883	275	11" Duo-Sweep Flagged Broom	Threaded	362019414
36860	275	7" Duo-Sweep Unflagged Broom	Threaded	362029403
36864	275	9" Duo-Sweep Unflagged Broom	Threaded	362029403
36884	275	11" Duo-Sweep Unflagged Broom	Threaded	362029403
Sweeps				
41880	278	18" Omni Sweep	Threaded	40225
41881	278	24" Omni Sweep	Threaded	40225
36204818	279	18" Foam Block Fine Sweep	Threaded	40225
36204824	279	24" Foam Block Fine Sweep	Threaded	40225
40564	279	18" Foam Block Medium Sweep	Threaded	40225
40565	279	24" Foam Block Medium Sweep	Threaded	40225
40561	279	18" Foam Block Medium Sweep	Threaded	40225
40562	279	24" Foam Block Medium Sweep	Threaded	40225
362208P18	279	18" Foam Block Medium Sweep	Threaded	40225
362208P24	279	24" Foam Block Medium Sweep	Threaded	40225
36207218	280	18" Foam Block Heavy Sweep	Threaded	40225
36207224	280	24" Foam Block Heavy Sweep	Threaded	40225
45222	280	24" Palmyra Heavy-Duty Sweep	Threaded/Tapered	40225
367618	280	18" Heavy-Duty Sweep	Threaded/Tapered	40276
367624	280	24" Heavy-Duty Sweep	Threaded/Tapered	40276
Floor & Deck Scrubs				
36175	283	10" Wood Block Sweep	Tapered	40261
36275	283	12" Wood Block Sweep	Tapered	40261
36193	283	10" Wood Block Scrub	Threaded/Tapered	40225
36192	283	10" Wood Block Sweep	Threaded/Tapered	40225
36292	283	12" Wood Block Scrub	Threaded/Tapered	40225
40423	283	10" Hi-Lo Floor Scrub Brush	Threaded	40225
36197	283	10" Dual Surface Scrub Brush	Threaded	40225
36190	283	10" Dual Action Scrub Brush	Threaded	40225
40422	283	10" Dual Action Scrub Brush	Threaded	40225
365300	284	8" Swivel Scrub	Threaded	40225
365310	284	8" Swivel Scrub	Threaded	40225
40430	284	9" Floor Scrub Brush	Threaded	40225
365320	285	Swivel Head Grout Brush	Threaded	40225
41323	285	9" Tile & Grout Brush	Threaded	40225

Prod No	Page	Description	Type of Handle	Recommended Handle
Floor Squeegees				
40081	285	18" Straight Steel Squeegee	Tapered	40261
40082	285	24" Straight Steel Squeegee	Tapered	40261
40083	285	30" Straight Steel Squeegee	Tapered	40261
366318	286	18" Straight Squeegee	Tapered	40261
366324	286	22" Foam Squeegee	Tapered	40261
366330	286	30" Soft Black Foam Rubber	Tapered	40261
41567	286	18" Plastic Squeegee	Threaded	40225
41568	286	24" Plastic Squeegee	Threaded	40225
366824	286	22" Foam Squeegee Threaded Socket	Threaded	40267
366918	286	18" Red Foam Rubber	Threaded	40225
366922	286	22" Red Foam Rubber	Threaded	40225
367818	287	18" Rubber Squeegee with Bristles	Threaded	40210
36324C	287	24" Curved End Black Rubber Squeegee	Tapered	40261
36336C	287	36" Curved End Black Rubber Squeegee	Tapered	40261
36567	287	20" Solid, One-Piece Rubber Squeegee	Threaded	40225
36568	287	24" Solid, One-Piece Rubber Squeegee	Threaded	40225
40075	288	18" Straight Steel Squeegee	Tapered	40261
40076	288	24" Straight Steel Squeegee	Tapered	40261
40077	288	36" Straight Steel Squeegee	Tapered	40261
Misc Floor Care				
40146	304	3" Floor Drain Brush	Threaded (Female)	40236
40147	304	4" Floor Drain Brush	Threaded (Female)	40237
41093	304	5" Floor Drain Brush	Threaded (Female)	40237
40148	304	6" Floor Drain Brush	Threaded (Female)	40238



CARLISLE
FOODSERVICE PRODUCTS

PROFESSIONAL
DURABLE
TOUGH
HARD-
WORKING
**TRANS-
PORTATION
EQUIPMENT**

Carlisle's high quality dollies, carts, and caddies help you reduce the risk of food contamination and employee injuries.





CARTS

Our unique combination of **space saving design, load capacity, and long-lasting durability** provide superior value and make Fold 'N Go the transport cart **every foodservice operation needs.**

Fold 'N Go® Carts

- Folds and unfolds in a single, quick and easy motion
- Each cart holds up to 350 lbs (approximately 116 lbs per shelf)
- Cart ships fully assembled; no tools or complicated latches required
- Collapses to 9" width and 10.5" width; stores easily behind doors, in between counters, or back of delivery vans
- Shelves are easy to clean; top shelf has ergonomically shaped, easy grip handles at both ends for a fast, secure grip
- SBC1521 shelf measures 20.5" L x 15" W; SBC2031 shelf measures 31.5" L x 18.5" W; with 11.5" shelf spacing
- 4" heavy-duty, non-marking swivel casters with molded-in metal reinforcement plates are permanently staked to .75" solid aluminum legs for longer life and added strength and rigidity

Licensed Product under U.S. Patent No. 5806864



SBC1521

SBC2031



350 lb Capacity



Easily folds with one hand

Find replacement parts at www.carlislefsp.com/replacement-parts

Bussing Carts

- Durable construction stands up to the toughest use
- Shelves are textured to minimize scratches and provide a better grip
- Convenient knockdown design is easy to assemble
- Available with optional back panels to hide clutter or locking doors to secure sensitive items like liquor or cleaning supplies (15" x 21" size only)



Find replacement parts at
www.carlislefsp.com/replacement-parts



CC2036DP, available with locking doors and side panels to secure sensitive items



Prod No	Description	Weight Capacity	Color	Pack
Fold 'N Go Carts				
SBC1521	15" x 21" Fold 'N Go Cart	350 lb	03, 23, 25	1 ea
SBC2031	20" x 31" Fold 'N Go Cart	350 lb	03, 23, 25	1 ea
SBCC240	Fold 'N Go Cart Replacement Caster, Swivel	—	00	1 ea
SBCC245	Fold 'N Go Cart Replacement Caster, Swivel with Brake	—	00	1 ea
SBCA30000	Fold 'N Go Cart Replacement Slide Bracket Assembly	—	—	1 ea
SBCRKIT	Fold 'N Go Hardware Replacement Kit (includes 2 casters)	—	—	1 ea
Bussing Carts				
CC2243 Δ	42" x 23" Large Bussing Cart	300 lb	03	1 ea
CC2036 Δ	18" x 36" Bussing Cart	300 lb	03	1 ea
CC2036DP	18" x 36" Bussing Cart with Doors and Back Panels	300 lb	03	1 ea
CC2036P	18" x 36" Bussing Cart with Back Panels	300 lb	03	1 set
CD2036	18" x 36" Doors and Back Panels Only	—	03	1 set
CP2036	18" x 36" Back Panels Only	—	03	1 set
CC11SH	Accessory Bin for Bussing Cart	—	03	1 ea
CC11TH	Trash Bin for Bussing Cart	—	03	1 ea

NSF Listed products are designated with a Δ and may be prefixed with an N

Shipping Notes: CC2036 & SBC1521 can ship UPS/FedEx Ground at oversize cost, CC2243 & SBC2031 cannot ship UPS/FedEx Ground



CARTS

Stainless Steel Utility Carts

- Utility carts are constructed of heavy gauge stainless steel for superior strength and durability
- Continuous weld construction provides added durability as compared to other, spot welded utility carts
- Non-marking soft rubber bumpers prevent scratches and scuffs on walls



UC4031529



UC3031524



UC7022133

Service Cart

- One-piece design, all plastic construction
- Polyethylene exterior and polyurethane foam core for added strength
- Heavy-duty 5" non-marking caster with molded-in metal reinforcement plates
- Optional Trash Container (SBC11TC) and Part Holder (SBC11SH) available separately
- NSF Listed



SBC230 with SBC11TC and SBC11SH



Find replacement parts at www.carlislefsp.com/replacement-parts



Black(03)

Prod No	Description	Weight Capacity	Color	Pack
Service Cart				
SBC230 Δ	Service Cart - 2 Fixed Casters, 2 Swivel Casters, 1 with Brake	500 lb	03	1 ea
SBC11SH	Part Holder for SBC230	—	03	1 ea
SBC11TC	Trash Container for SBC230	—	03	1 ea
Stainless Steel Utility Carts				
UC3031524	15.5" x 24", 3 Shelf Utility Cart	300 lb	—	1 ea
UC3031827	18" x 27", 3 Shelf Utility Cart	300 lb	—	1 ea
UC5031524	15.5" x 24", 3 Shelf Utility Cart	500 lb	—	1 ea
UC5031827	18" x 27", 3 Shelf Utility Cart	500 lb	—	1 ea
UC5032135	21" x 35", 3 Shelf Utility Cart	500 lb	—	1 ea
UC7031524	15.5" x 24", 3 Shelf Utility Cart	700 lb	—	1 ea
UC7031827	18" x 27", 3 Shelf Utility Cart	700 lb	—	1 ea
UC7022133	21" x 33", 2 Shelf Utility Cart	700 lb	—	1 ea
UC7032133	21" x 33", 3 Shelf Utility Cart	700 lb	—	1 ea
UC4031529	15.75" x 29.5", 3 Shelf Knock-Down Utility Cart	400 lb	—	1 ea
UC4031733	17.75" x 33.38", 3 Shelf Knock-Down Utility Cart	400 lb	—	1 ea

NSF Listed products are designated with a Δ and may be prefixed with an N

Shipping Notes: SBC230, UC3031524, UC3031827, UC5031524, UC5031827, UC5032135, UC7031524, UC7031827, UC7022133, UC7032133 cannot ship UPS/FedEx



Utility Carts

- Excellent for transporting equipment and heavy loads
- Bin top utility carts (UC4018 & UC4525) reduce the potential for items to fall off during transport
- Durable and chemical-resistant polypropylene construction; will not rust, dent, chip, or peel
- Convenient knock-down design
- Integrated cord wrap for easy access (UC1940)



UC4018



UC1940



Find replacement parts at
www.carlislefsp.com/replacement-parts



Prod No	Description	Weight Capacity	Color	Pack
Utility Carts				
UC1940	19" x 40" x 32.5" Utility Cart	500 lb	23	1 ea
UC4018	40" x 17.25" Small Bin Top Utility Cart	500 lb	23	1 ea
UC4525	45" x 25" Large Bin Top Utility Cart	500 lb	23	1 ea
UCC4018	Replacement Casters for UC4018 & UC4525 (Swivel, 2 pack)	—	00	1 cs
UCC4525	Replacement Casters for UC4018 & UC4525 (Fixed, 2 pack)	—	00	1 cs



DISH DOLLIES

Optimizer™ Adjustable Dish Dollies

- Adjustable dividers eliminate the need for individually sized dollies
- Dollies hold plates from 5.5" to 12.5"
- Polyethylene dividers and walls help prevent dish edge chipping
- Two-handed access to all plates reduces breakage
- Non-marking casters (2 locking, 2 non-locking) for easy transport of loaded dollies
- Includes vinyl cover with easy-opening hook & loop side included for sanitary storage
- Find replacement parts at www.carlislefsp.com/replacement-parts
- NSF Listed



ADD4, ADD6 Optimizer Dollies Also Feature:

- Most flexible dolly available; holds trays, plates, and platters
- ADD6 holds oval platters from 9.5" x 7.25" to 13.5" x 10.5"
- Holds 5 stacks of 9.88" to 11.25" plates; 25% more than any other similar dish dolly
- Holds 8 stacks of 5.5" to 8.25" plates; 33-50% more than any other similar dish dolly (up to 50 or more plates per stack, depending on plate profile)
- Use 2 to 4 dividers for 10" or larger plates; 6 dividers for 8" to 9.75" plates; 8 dividers for 8 stacks of 7.75" or smaller plates
- 2 dividers for 13.5" x 10.5" platters; 6 dividers for 9.5" x 7.25" to 12" x 9.25" platters.

ADS4, ADS8 Optimizer Dollies Also Feature:

- Smaller size fits through narrow corridors or under tables
- Flexible configuration holds a variety of plates and platters



ADS4



ADD4

ADD6 Vinyl Cover with ADD6



WARNING: Products identified on this page with the following symbol ▼ contain chemicals, including one or more phthalates, known to the State of California to cause cancer and birth defects and other reproductive harm.



Prod No	Description	Color	Pack
Optimizer Standard Dish Dollies & Accessories			
ADD4 ▲	Optimizer Dish Dolly with 4 Dividers	01, 03	1 ea
ADD6 ▲	Optimizer Dish Dolly with 6 Dividers	01, 03	1 ea
ADD4 ▼	Optimizer Replacement Dividers (Set of 2)	01, 03	2 ea
ADD6 ▼	Optimizer Vinyl Replacement Cover (for ADD4 or ADD6)	07	1 ea
ADDR	Divider Replacement Hardware (Rod, Washers, Knob)	03	4 ea
Optimizer Small Dish Dollies & Accessories			
ADS4 ▲	Optimizer Small Dish Dolly and 4 Adjustable Dividers	03	1 ea
ADS8 ▲	Optimizer Small Dish Dolly and 8 Adjustable Dividers	03	1 ea
ADS4 ▼	Optimizer Replacement Dividers (Set of 4)	03	1 ea
ADS8 ▼	Optimizer Vinyl Replacement Cover (for ADS4 or ADS8)	07	1 ea

NSF Listed products are designated with a ▲ and may be prefixed with an N
 Note: ADD4, ADD6, ADS4, ADS8 cannot ship UPS/FedEx

Optimizer Adjustable Dish Dolly Guide

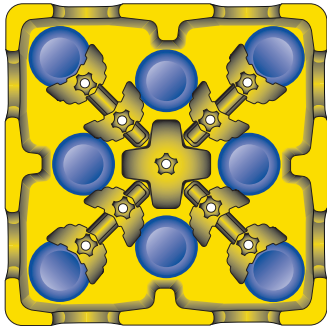

ADS8 Layout for 5.5" round plates

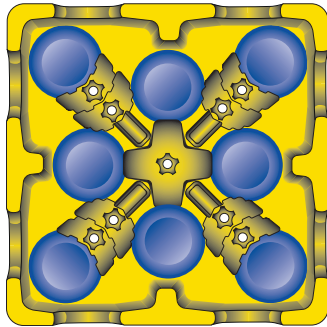

ADS8 Layout for 6.5" round plates

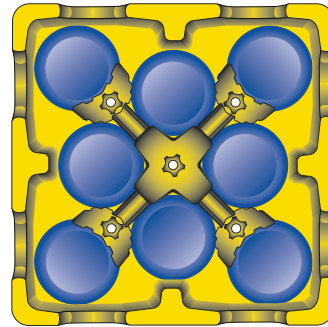

ADS4 Layout for 7.5" round plates and 6" square plates

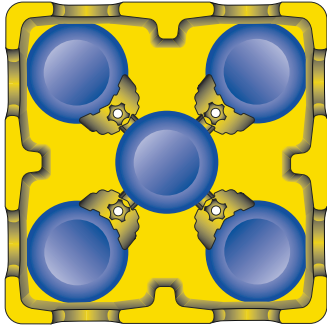

ADS4 Layout for 9" round plates

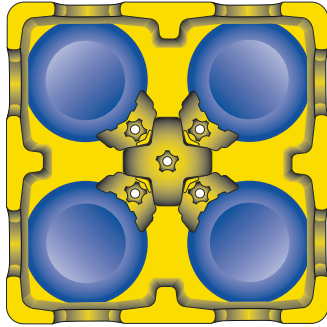

ADS4 Layout for 11" round plates and 8.5" square plates

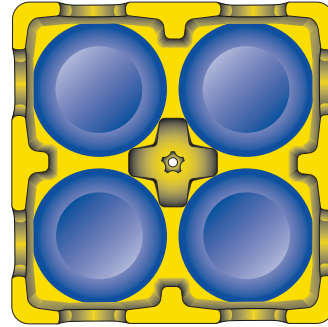

ADS4 Layout for 12" round plates

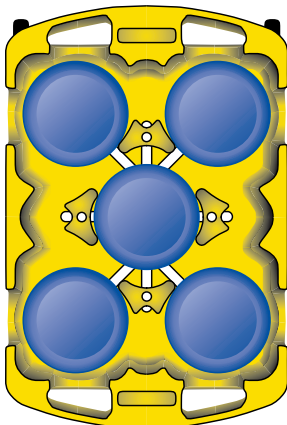

ADD4 Layout for 9.88" to 11.25" round plates

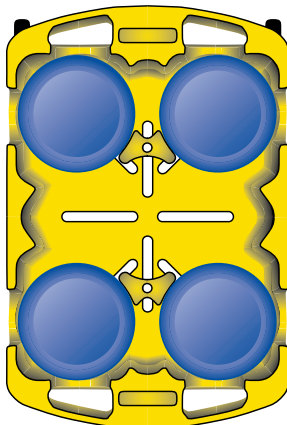

ADD4 Layout for 11.38" to 12.5" round plates, 8.5" to 10.5" square plates and 13.5" by 10.5" platters

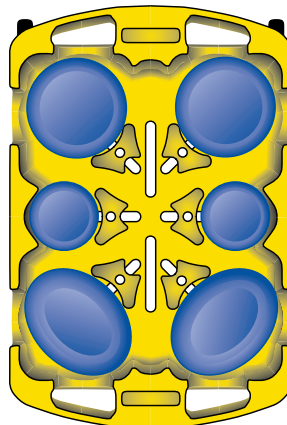

ADD6 Layout for 12" by 9" to 9.5" by 7.25" platters, 5.5" to 8" and 5.5" to 12" round plates

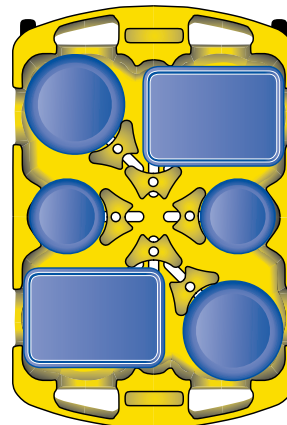

ADD6 Layout for 10" by 14.5" trays and 7.5" and 10" round plates

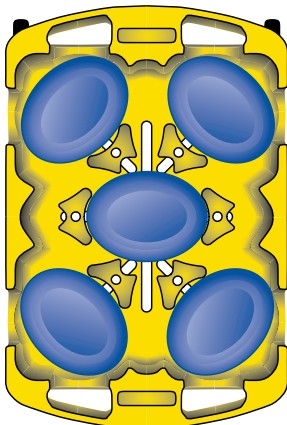

ADD6 Layout for 12" by 9.25" to 9.5" by 7.25" platters

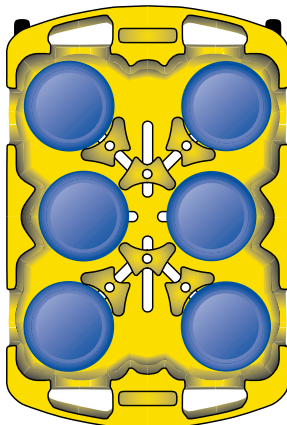

ADD6 Layout for 8.38" to 9.75" round plates

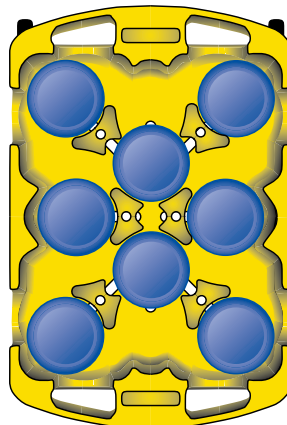

ADD6 Layout for 8" to 8.25" round plates

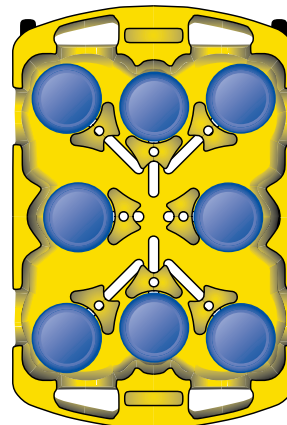

ADD6 Layout with 2 Additional Dividers for 5.5" to 7.88" round plates



JANITORIAL CARTS

Janitorial Carts & Accessories

- Rugged polypropylene resists cracking, peeling, and corrosion
- Three durable shelves with raised edges keep items organized
- Platform base holds a Bucket/Wringer or 23 gallon TrimLine™ Waste Container
- Includes a 25 gallon nylon bag for waste or laundry collection
- 3" standard Carlisle non-marking swivel casters in front; large 8" non-marking rear wheels





Integrated tool holders, shelves, and hooks keep everything organized including unwieldy handles.



Front hooks hold most standard Wet Floor Signs. Built-in hanger holds multiple spray bottles.



Structurally reinforced base and heavy-duty casters/wheels withstand rough use – holds up to 300 lbs.



Tough 25 gallon nylon bag easily attaches to cart arm. Hooks on top of arm to hold trash liners in place. Arm swings up for more compact storage when not in use.



Tool Caddy

- Handled caddy fits in the top compartment of the JC1945 cart series
- Deep compartments prevent spills
- Made of durable polypropylene



Prod No	Description	Weight Capacity	Color	Pack
Janitorial Carts & Accessories				
JC1945S	45"L x 19"W x 39"H Short Platform Janitorial Cart	300 lb	23	1 ea
JC1945L	49"L x 19"W x 39"H Long Platform Janitorial Cart	300 lb	23	1 ea
JC1946	Replacement Bag for JC1945S & JC1945L	—	14	1 ea
JC1945CB	Tool Caddy for Janitorial Cart	—	23	1 ea
36908C	3" Replacement Casters	—	00	2 ea



CARLISLE
FOODSERVICE PRODUCTS



RUGGED
QUALITY
DURABLE
**WASTE
MANAGEMENT
PRODUCTS**

Carlisle offers a solution for all of your waste and material handling needs. Our products are built to last and feature the rugged construction and durability you expect.



WASTE CONTAINERS & LIDS

TrimLine™

- Designed for narrow spaces
- Self-venting for easier bag removal
- Corner tabs keep bag in place
- Helper handle on bottom makes lifting and dumping easier



Wire Dolly

- Compact design for easy storage
- For use with 23 gallon size container
- 100 lb weight capacity



Prod No	Description	Color	Pack
TrimLine Containers			
342015	15 gal TrimLine Container	23	4 ea
342023	23 gal TrimLine Container	03, 06, 09, 14, 23, 69	4 ea
342024	TrimLine Swing Top Lid, 20.13" x 11.5" x 4.5"	03, 06, 23, 69	4 ea
342025	TrimLine Handled Lid, 20.5" x 11.5" x 3"	03	4 ea
36920-1	Wire Frame Dolly for 23 gal TrimLine Container	03	1 ea

WASTE CONTAINERS & LIDS

When it comes to **waste and material handling**, you can count on Carlisle to deliver products designed for **heavy duty usage**.

Bronco™

- Heavy-duty construction with double-reinforced stress ribs; drag skids for durability
- Comfort Curve™ handles provide easy handling
- Helper handles on base for controlled tipping or overhead lifting
- Reinforced lids have snap down tab locks with a simple press & pull release system for easy removal
- NSF Std 21 – meets the criteria for thermoplastic refuse containers
- NSF Std 2 – meets the criteria for food contact and cleanability

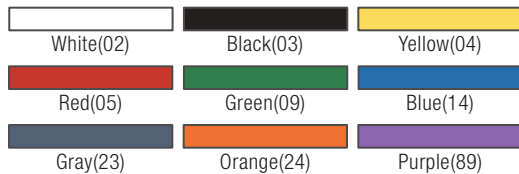

Prod No	Description	Color	Pack
Bronco Round Waste Containers & Lids			
341010 Δ	10 gal Waste Container, 16.13" x 17"	02, 03, 04, 05, 09, 14, 23, 24, 89	6 ea
341011 Δ	10 gal Lid, 16.13" x 2"	02, 03, 04, 05, 09, 14, 23, 24, 89	6 ea
341020 Δ	20 gal Waste Container, 20" x 23"	02, 03, 04, 05, 09, 14, 23, 24, 89*	6 ea
341021 Δ	20 gal Lid, 20" x 2.13"	02, 03, 04, 05, 09, 14, 23, 24, 89*	6 ea
341032 Δ	32 gal Waste Container, 22.38" x 27.75"	02, 03, 04, 05, 09, 14, 23, 24, 89	4 ea
341033 Δ	32 gal Lid, 24" x 2.13"	02, 03, 04, 05, 09, 14, 23, 24, 89	4 ea
341034	32 gal Dome Lid	03	1 ea
341035	32 gal Funnel Lid	03	4 ea
341044 Δ	44 gal Waste Container, 26.88" x 31.38"	02, 03, 04, 05, 09, 14, 23, 24, 89	3 ea
341045 Δ	44 gal Lid 26.88" x 2.25"	02, 03, 04, 05, 09, 14, 23, 24, 89	3 ea
341055 Δ	55 gal Waste Container, 26.5" x 33"	02, 03, 04, 05, 09, 14, 23, 89*	2 ea
341056 Δ	55 gal Lid, 26.5" x 2.25"	02, 03, 04, 05, 09, 14, 23, 89*	2 ea
341057	44/55 gal Dome Lid	03	1 ea
341132 Δ	32 gal Container with Dolly, 22.38" x 38.25"	02, 04, 05, 09, 14, 23	4 ea
341144 Δ	44 gal Container with Dolly, 26.88" x 37.75"	02, 04, 05, 09, 14, 23	3 ea

*Made to order

NSF Listed products are designated with a Δ and may be prefixed with an N



9 Colors

Our round Bronco containers come in 9 colors and are made with NSF 2 certified materials which meet the criteria for food contact and cleanability. Excellent for storing and segregating large amounts of food products.



Hot Stamped Bronco™ Containers

- Carlisle offers several standard Hot Stamped containers for waste management, visit carlislefsp.com/custom-imprinting
- Standard stamps:
 - INEDIBLE
 - USDA CONDEMNED
 - TRASH
 - ICE ONLY
 - ICE MELT
- Custom hot stamping is also available; contact Customer Service at 1-800-654-8210 for custom imprinting information



341010ICE

Tool Caddy Bag

- Economical, adjustable caddy bag can hold an assortment of cleaning tools
- Turns a 32 or 44 gallon Bronco into a portable and durable cleaning system platform



36917

Carlisle Dollies

- Dollies fit our 20, 32, 44, and 55 gallon containers for safe transport of heavy loads
- Simple twist-to-lock feature securely attaches dolly to containers
- Dollies include standard Carlisle non-marking 3" swivel casters
- NSF Std 2—meets the criteria for food contact and cleanability



36910



Prod No	Description	Color	Pack
Hot Stamped Bronco Container			
341010ICE Δ	10 gal "Ice Only" Container	02	6 ea
Tool Caddy Bag			
36917	Tool Caddy Bag for 32 & 44 gal Bronco Waste Containers	04	12 ea
Carlisle Dollies			
36911 Δ	Standard Round Container Dolly, 17.75" x 6"	03	2 ea
36910 Δ	Round Container Dolly with Replaceable Casters	03	2 ea
3672231	3" Replacement Caster for 36910 Dolly	—	1 ea

NSF Listed products are designated with a Δ and may be prefixed with an N

WASTE CONTAINERS & LIDS

Square Bronco™

- Heavy-duty construction with double-reinforced stress ribs; drag skids for durability
- Comfort Curve™ handles provide easy handling
- Helper handles on base for controlled tipping or overhead lifting
- Reinforced lids have snap down tab locks with a simple press & pull release system for easy removal



50 Gallon Roll-Away Container

- Super heavy-duty axle and oversize traction wheels make hauling heavy loads easy
- Unique handle design gives positive grip even when wet
- Sturdy hinged lid flips open 270° and snaps shut tight
- NSF Std 21 – meets the criteria for thermoplastic refuse containers
- NSF Std 2 – meets the criteria for food contact and cleanability



Prod No	Description	Color	Pack
Square Bronco Waste Containers & Lids			
341528	28 gal Square Bronco Waste Container	02, 23	6 ea
341529	Square Bronco Lid for 341528	02, 23	6 ea
341540	40 gal Square Bronco Waste Container	02, 23	4 ea
341541	Square Bronco Lid for 341540	02, 23	4 ea
341542	Dolly for 28/40 gal Square Bronco Container	03	2 ea
Roll-Away Container			
345050 Δ	50 gal Rolling Container, 21" x 21" x 38.25"	14, 23	2 ea

Centurian™

- Attractive yet durable
- Self-venting design for easier bag removal
- Corner tabs keep bag in place



Prod No	Description	Color	Pack
Centurian Waste Containers			
343021	21 gal Half Round Centurian Container	06, 23	4 ea
343022	Half Round Centurian Lid for 343021	03, 06, 23	4 ea
343122	22 gal Tall Round Centurian Container	23	4 ea
343123	Swing Top Centurian Lid for 343122	23	4 ea
343124	Funnel Top Centurian Lid for 343122	23	4 ea
343523	23 gal Tall Square Centurian Container	06, 23, 69	4 ea
343525	Swing Top Centurian Lid for 343523	03, 06, 23, 69	4 ea
343935	35 gal Centurian Square Waste Receptacle	06, 23	4 ea
343950	50 gal Centurian Square Waste Receptacle	06, 23	4 ea
343951	Large Centurian Lid for 343935, 343950	06, 23	4 ea

Office Wastebaskets

- Economical polypropylene
- Smooth inner surface makes cleaning easy
- Light yet durable design



Fire Resistant Wastebaskets

- Ideal for use in areas or applications requiring an extra degree of fire protection including schools, health care, and hospitality
- Textured finish minimizes appearance of scuffs and scratches
- UL Listed; will contain burning paper without contributing fuel to the fire



Prod No	Description	Color	Pack
Office Wastebaskets			
342913	13 qt Office Wastebasket	03, 06, 23	12 ea
342928	28 qt Office Wastebasket	03, 06, 23	12 ea
342941	41 qt Office Wastebasket	03, 06, 23	12 ea
Fire Resistant Wastebaskets			
342915	14 qt Fire Resistant Wastebasket	03	6 ea
342927	28 qt Fire Resistant Wastebasket	03	6 ea
342940	41 qt Fire Resistant Wastebasket	03	4 ea

RECYCLE CONTAINERS & ACCESSORIES

Recycle options are great for offices, hospitality, industrial, restaurants, and more.

Bronco™



341032REC



341032REC

341033REC

Centurian™



343527REC

343523REC



343937REC

343935REC



343022

343021REC



Prod No	Description	Color	Pack
Bronco Recycle Waste Containers & Lids			
341020REC Δ	20 gal Recycle Waste Container	09, 14	6 ea
341021REC Δ	20 gal Recycle Lid with 8" Hole	09, 14	6 ea
341032REC Δ	32 gal Recycle Waste Container	09, 14	4 ea
341033REC Δ	32 gal Recycle Lid with 8" Hole	09, 14	4 ea
341044REC Δ	44 gal Recycle Waste Container	09, 14	3 ea
341045REC Δ	44 gal Recycle Lid with 8" Hole	14	3 ea
Centurian Recycle Waste Containers & Lids			
343021REC	21 gal Half Round Centurian Recycle Container	14	4 ea
343022	Half Round Centurian Lid for 343021REC	03	4 ea
343523REC	23 gal Tall Square Centurian Recycle Container	14	4 ea
343526REC	Paper Recycle Centurian Lid for 343523REC	14	4 ea
343527REC	Bottle/Can Recycle Centurian Lid for 343523REC	14	4 ea
343935REC	35 gal Recycle Centurian Square Waste Receptacle	14	4 ea
343950REC	50 gal Recycle Centurian Square Waste Receptacle	14	4 ea
343936REC	Bottle/Can Recycle Centurian Lid for 343935REC, 343950REC	14	4 ea
343937REC	Paper Recycle Centurian Lid for 343935REC, 343950REC	14	4 ea
34RECLBL	Recycle Label Kit	—	1 ea

NSF Listed products are designated with a Δ and may be prefixed with an N

TrimLine™



Recycle Label Kit



34RECLBL
Includes one set of eleven color-coded symbol labels and three sets of eleven word labels in English, Spanish and French



Roll-Away



Office Wastebaskets



Prod No	Description	Color	Pack
TrimLine Recycle & Compost Containers & Lids			
342015REC	15 gal TrimLine Recycle Container	14	4 ea
342023REC	23 gal TrimLine Recycle Container	09, 14	4 ea
342023CMP	23 gal TrimLine Compost Container	09	4 ea
342026REC	Paper Recycle Lid for 343023REC & 342015REC	14	4 ea
342027REC	Bottle/Can Recycle Lid for 343023REC & 342015REC	14	4 ea
342025	TrimLine Handled Lid	03, 09, 14	4 ea
Carlisle Roll-Away Recycle Container			
345050REC Δ	50 gal Recycle Rolling Container	14	2 ea
Office Recycle Wastebaskets			
342913REC	13 qt Office Recycle Wastebasket	14	12 ea
342928REC	28 qt Office Recycle Wastebasket	14	12 ea
342941REC	41 qt Office Recycle Wastebasket	14	12 ea
Recycle Label Kit			
34RECLBL	Recycle Label Kit	—	1 ea

NSF Listed products are designated with a Δ and may be prefixed with an N

TILT TRUCKS

Perfect for **transporting bulky loads** and/or consolidating smaller loads for more **efficient transport**

- Lightweight, durable, rotationally molded design improves maneuverability
- Smooth inner and outer surface makes cleaning easy
- Non-marking, swivel casters allow for easy transportation
- 5/8 Yard easily fits through standard doorways
- Made with more than 70% post consumer recycled material
- Meets EPA recommended recovered materials content levels for office recycling containers and waste receptacles and is perfect for specifying on school and government agency bids
- Lids available for each size
- Powder coated steel wheel frame



5/8 Yard Capacity

Light Duty – 450lb
 Standard Duty – 850lb
 Wheel Diameter: 10"
 Dimensions: 26"W x 38"H x 54"L
 (fits through standard doorway)



1 Yard Capacity

Standard Duty – 850lb
 Heavy Duty – 1,20lb
 Wheel Diameter: 10"
 Dimensions: 32.5"W x 42.75"H x 68"L



1.5 Yard Capacity

Heavy Duty – 1,20lb
 Wheel Diameter: 12"
 Dimensions: 40.5"W x 48.5"H x 79.5"L



Lids Available
 For Each Size



Black(03)

Prod No	Description	Weight Capacity	Color	Pack
Tilt Trucks				
TTLD580	5/8 Yard Light Duty	450lb	03	1 ea
TTS580	5/8 Yard Standard Duty	850lb	03	1 ea
TTL580	5/8 Yard Tilt Truck Lid	—	03	1 ea
TTS100	1 Yard Standard Duty	850lb	03	1 ea
TTH100	1 Yard Heavy Duty	1200lb	03	1 ea
TTL100	1 Yard Tilt Truck Lid	—	03	1 ea
TTS150	1.5 Yard Standard Duty	1200lb	03	1 ea
TTL150	1.5 Yard Tilt Truck Lid	—	03	1 ea



REPLACEMENT PARTS

In order to better identify and find the replacement parts you are looking for, we have created an easy-to-use web page. Please use the web address below and the steps outlined to navigate and find what you are looking for.

www.carlislefsp.com/replacement-parts

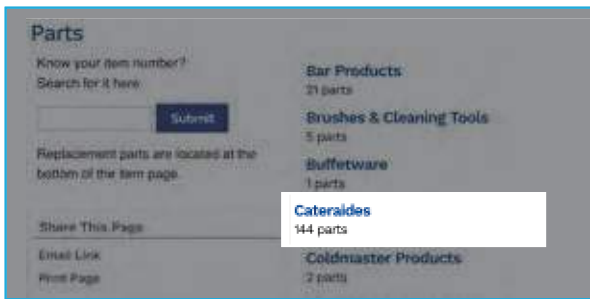
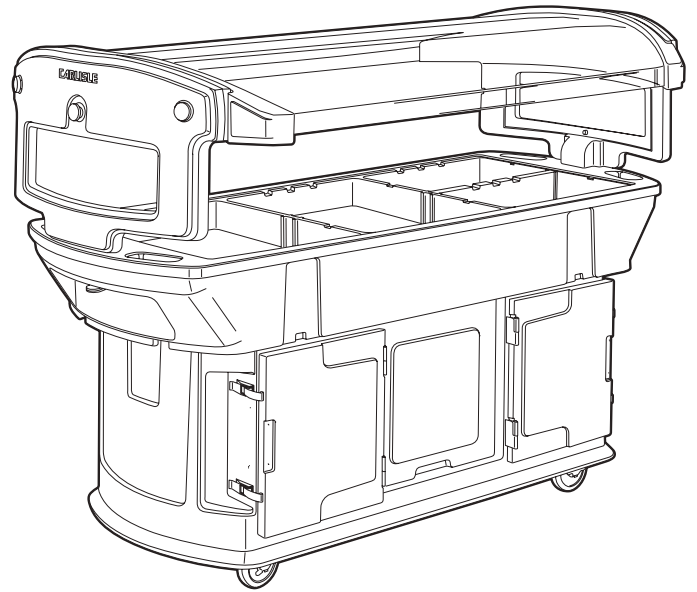

2. Replacement Parts Landing Page

You will navigate to a list of product groups with the total amount of parts available listed below the title

Click on the category you need or search by item #



3. Category Listing

After choosing your category, you will find a list of products within that category

Click on the item that needs a new part



4. Available Replacement Parts Drop Down Menu

A drop down menu will reveal the available replacement parts for your product

Click on the specific replacement part that you need

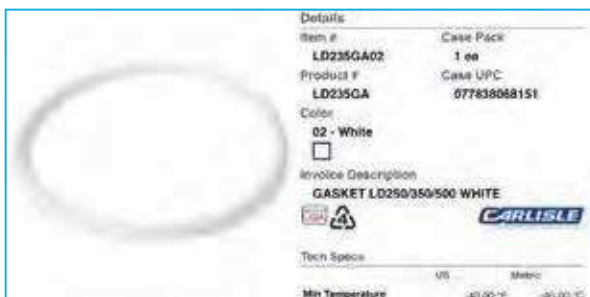

5. Replacement Part Item Page

Lastly, you will be taken to an item level web page that will list additional information for the part

CUSTOM DECORATING

For more information and a complete list of custom decorating options please visit the url below.

www.carlislefsp.com/customer-service/custom-decorating

Carlisle offers a variety of options to customize the products that we produce. From screen printing to hot stamping, we can add your logo to items ranging from plates to trash cans.

For more information please visit our custom decorating webpage listed above or contact Carlisle Customer Service by phone at 1-800-654-8210 or via email at customerservice@carlislefsp.com



PRODUCT INDEX

Prod No	Page No	Prod No	Page No	Prod No	Page No	Prod No	Page No
0120.....	43	0844.....	61	1031.....	159	10536U.....	220
0132.....	43	0845.....	61	10310U.....	219	10537U.....	220
0200.....	229	0852.....	60	10311U.....	219	10538Z.....	220
0202.....	116-117, 229	0855.....	59	10316U.....	219	10539Z.....	220
0203.....	229	0860.....	58	10317U.....	219	10601.....	141
0205.....	229	0862.....	58	10318Z.....	219	10602.....	141
0240.....	119	0864.....	59	10319Z.....	219	10610.....	224
0261.....	119	0873.....	60	10335.....	219	10611.....	224
0287.....	119	0875.....	60	10336U.....	219	10611C.....	224
0295.....	119	0878.....	60	10338Z.....	219	10612.....	224
0296.....	119	1000B.....	85	10339Z.....	219	10612C.....	224
0300.....	116	10145.....	158	10400B.....	220	10617.....	224
0301.....	116	10200B.....	218	10401B.....	220	10617C.....	224
0302.....	116	10201B.....	218	10402B.....	220	10620.....	224
0304.....	116	10202B.....	218	10410U.....	220	10621.....	224
0306.....	117	10203B.....	218	10411U.....	220	10621C.....	224
0311.....	116	10210U.....	218	10415.....	220	10622.....	224
0316.....	116	10211U.....	218	10416U.....	220	10622C.....	224
0333.....	65	10212B.....	218, 220	10417U.....	220	10623.....	224
0338.....	61	10215.....	218	10420B.....	220	10623C.....	224
0340.....	95	10216U.....	218	10421B.....	220	10624.....	224
0341.....	116	10217U.....	218	10422B.....	220	10624C.....	224
0342.....	116	10220B.....	218	10423B.....	220	10627.....	224
0343.....	116	10221B.....	218	10430U.....	220	10627C.....	224
0344.....	95	10222B.....	218	10431U.....	220	10628.....	224
0345.....	28	10223B.....	218	10435.....	220	10629.....	224
0347.....	28	10230U.....	218	10436U.....	220	10630.....	225
0350.....	229	10231U.....	218	10437U.....	220	10631.....	225
0355.....	229	10232B.....	218, 220	10438Z.....	220	10632.....	225
356.....	64	10235.....	218	10439Z.....	220	10637.....	225
0362.....	61	10236U.....	218	10440B.....	220	10640.....	225
0365.....	117	10238Z.....	218	10440Z.....	220	10641.....	225
0372.....	117	10239Z.....	218	10441B.....	220	10642.....	225
0386.....	249	10240B.....	218	10450U.....	220	10643.....	225
0411.....	89	10240Z.....	218	10456U.....	220	10644.....	225
0470.....	66	10241B.....	218	10457U.....	220	10647.....	225
0475.....	66	10250U.....	218	10470U.....	220	10648.....	225
0600.....	229	10256U.....	218	10471U.....	220	1071.....	249
0602.....	116, 229	10257U.....	218	10476U.....	220	10720.....	226
0603.....	229	10270U.....	219	10477U.....	220	10721.....	226
0605.....	229	10271U.....	219	10478Z.....	220	10722.....	226
0700.....	67	10276U.....	219	10479Z.....	220	10723.....	226
0703.....	67	10277U.....	219	10480Z.....	220	10724.....	226
0707.....	67	10278Z.....	219	10490U.....	220	10725.....	226
0710.....	67	10279Z.....	219	10491U.....	220	10726.....	226
0713.....	67	10280Z.....	219	10496U.....	220	10730.....	226
0717.....	67	10290U.....	219	10497U.....	220	10731.....	226
0800.....	229	10291U.....	219	10510U.....	220	10732.....	226
0805.....	229	10296U.....	219	10511U.....	220	10733.....	226
0820.....	61	10297U.....	219	10516U.....	220	10734.....	226
0830.....	61	1030.....	159	10518Z.....	220	10735.....	226
0831.....	61	10302FMT.....	154	10519Z.....	220	10736.....	226
0843.....	61	1030FMT.....	154	10535.....	220	10740.....	226

PRODUCT INDEX

Prod No	Page No	Prod No	Page No	Prod No	Page No	Prod No	Page No
10741	226	11801	193	1418LFG	153	2216DFGQ	153
10742	226	11828	267	1418LWFG	153	2216FG	153
10761	228	11829	267	1418PC	154	2216FGQ	153
10763	228	11830	267	1419DFG	153	2216GR2Q	160
10764	228	11831	267	1419FG	153	2216WFGQ	153
10765	228	11832	267	1419WFG	153	2219	131
10766	228	11833	267	1520LDFG	153	2227	131
10767	228	11879	193	1520LFG	153	2229	131
10768	228	1200	229	1520LWFG	153	2230	131
10769	228	1202	229	1532	227	2310DFG	153
10770	228	1205	229	1544	227	2310FG	153
10771	228	1212FG	153	1556	227	2310WFG	153
10772	228	1212WFG	153	1568	227	2419	161
10773	228	1216LDFG	153	1600GL	161	2500	61
10806	126	1216LFG	153	1600GR2	160	2500GR2	160
10807	126	1216LWFG	153	1612DFG	153	2512	99
10820	131	1217BT	155	1612FG	153	2618DFGQ	153
10828	129	1218FMT	154	1612GR2	160	2618FGQ	153
10850	130	1219LDFG	153	1612WFG	153	2618FMTQ	154
10851	130	1219LFG	153	1629	227	2618WFGQ	153
10852	130	1219LWFG	153	1713DFG	153	269DFG	153
10853	130	1220DFG	153	1713FG	153	269FG	153
10854	130	1220FG	153	1713WFG	153	269FMT	154
10856	130	1220WFG	153	1800	229	269WFG	153
10857	130	1222LDFG	153	1805	229	2700GR2	160
10880	193	1222LFG	153	1814DFG	153	2710	231
10881	193	1222LWFG	153	1814FG	153	2823	161
10882	193	1230FMT	154	1814GR2	160	3004	99
10883	193	1250B	85	1814WFG	153	3013	161
10884	193	1252	229	1826GR2Q	160	3014	161
10885	193	12875	197	1900	32	3015	161
10886	193	12876	197	1960	32	3016	161
10887	193	12877	197	1965	32	3020	159
10888	193	12881	193	1987	32	3022	159
10889WC	193	12882	193	1989	32	3042	136-137
10897	193	12886	193	1991	32	30580	219-220
10901	193	12887	193	1992	32	30581	219-220
1100GL	161	12891	193	1993	32	30582	219-220
1100GR2	160	12892	193	1994	32	30583	219-220
11020	105	12901	193	2015DFG	153	30660	219
11026	105	1300	68	2015FG	153	30661	219
11030	105	1318DFG	153	2015GR2	160	30662	219
11036	105	1318FG	153	2015WFG	153	30669	219
1104	43	1318FMT	154	2115DFG	153	30670	219
1105	43	1319BT	155	2115FG	153	30680	219
1108	43	1400GL	161	2115WFG	153	30681	219
1110	43	1400GR2	160	2200	229	30682	219
1110L	55	1401	159	2205	229	30683	219
1112	43	1410DFG	153	2209	131	30684	219
1112L	55	1410FG	153	2210	131	30685	219
1116	43	1410GR2	160	2214DFG	153	30686	219
11789	193	1410WFG	153	2214FG	153	30687	219
11799	193	1418LDFG	153	2214WFG	153	30688	219

PRODUCT INDEX

Prod No	Page No	Prod No	Page No	Prod No	Page No	Prod No	Page No
30689	219	33312	80	342928	325	36232	305
30695	219	33314	80	342928REC	327	36233	305
30860	220	33316	80	342940	325	36236	282
30860H	221	33318	80	342941	325	36239	266
30860HH	221	33320	80	342941REC	327	36275	283, 306
30861	220	33322	80	343021	324	36289	261
30861H	221	33324	80	343021REC	326	36292	283, 306
30861HH	221	33326	80	343022	324, 326	363156	270
30862	220	33360	79	343122	324	36324C	287, 307
30869	220	33362	79	343123	324	3633019	294
30870	220	33364	79	343124	324	3633118	293
30871	221	339	95	343523	324	3633124	293
30880	220	34RECLBL	326, 327	343523REC	326	3633136	293
30881	220	341010	321	343525	324	3633218	293
30882	220	341010ICE	197, 322	343526REC	326	3633224	293
30883	220	341011	197, 321	343527REC	326	3633519	293
30884	220	341020	321	343935	324	3633525	293
30885	220	341020REC	326	343935REC	326	3633537	293
30886	220	341021	321	343936REC	326	36336C	287, 307
30887	220	341021REC	326	343937REC	326	3633670	293
30888	220	341032	321	343950	324	363404	270
30895	220	341032REC	326	343950REC	326	363725	264
30896	220	341033	321	343951	324	3647248	294
3100GR2	160	341033REC	326	345050	323	3647524	294
3210	141	341034	321	345050REC	327	3647536	294
3211	141	341035	321	36P5	305	3647548	294
3253GR2	160	341044	321	3610140	263	36490R	294
33000	16	341044REC	326	361410	282	365015	269
33002	16	341045	321	36141003-1	282	36505L	269
33004	16	341045REC	326	361412	281	36506L	269
33006	16	341055	321	361415	281	365117	270
33008	16	341056	321	361416	281	365120	270
33010	16	341057	321	361420	282	365300	284, 306
33012	16	341132	321	361437	282	365310	284, 306
33016	16	341144	321	36175	283, 306	365320	285, 306
33018	16	341528	323	36190	283, 306	365351	285
33020	16	341529	323	36192	283, 306	365380	284
33024	16	341540	323	36193	283, 306	365408	290
33030	17	341541	323	36197	283, 306	365450	270
33032	17	341542	323	362013	291	365501	263
33034	17	342015	320	3620194	274-275, 290	366318	286, 307
33036	17	342015REC	327	3620294	274-275, 290	366324	286, 307
33038	17	342023	320	36204818	279, 306	366330	286, 307
33040	17	342023CMP	327	36204824	279, 306	366824	286, 307
33042	17	342023REC	327	36207218	280, 306	366918	286, 307
33080	17	342024	320	36207224	280, 306	366922	286, 307
33082	17	342025	320, 327	36211	271	367600TC	263
33086	17	342026REC	327	362113	291	367618	280, 306
3312	62	342027REC	327	36219618	278	367624	280, 306
3316	62	342913	325	36219624	278	367818	287, 307
3319	62	342913REC	327	36219663	284	369024C	300
33302	80	342915	325	362208P18	279, 306	369024R	300
33310	80	342927	325	362208P24	279, 306	369066B	300

PRODUCT INDEX

Prod No	Page No	Prod No	Page No	Prod No	Page No	Prod No	Page No
369070B	300	36592	288	38332BH	138	40021	266
369074B	300	36596	288	38342BH	138	40022	266
36908C	303, 317	36633	276	38360	196	40023	266
36908W	303	36634	277	38360A	196	40024	261
369082	300	3672231	322	38480	196	40025	259
36920-1	320	36752	263	38480A	196	40026	264
369320	298	3682	276	38502	127	40027	265
369365	302	36853	275	38503	127	40028	260
369375	302	36854	275	38504	127	40040	260
369412B	297	36859	275, 306	38600R	114	40042	260
369413B	297	36860	275, 306	38601	127	4006	118
369418B	297	36861	274	386010	127	40070	270-271
369419B	297	36863	275, 306	386230IB	127	40071	270-271
369420	298	36864	275, 306	38623IB	127	40074	270-271
369424B	297	36865	274	38655	27, 114	40075	288, 307
369425B	297	36867	274	38704C	139	40076	288, 307
369430	297	36868	274	38704CNS	139	40077	288, 307
369442B	297	36873	275	38704CSIB	139	4008	43
369448B	297	36874	275	38705C	139	40081	288, 307
369454B	297	36883	275, 306	38706C	139	40082	307
369460	297	36884	275, 306	38800GLC	129	40083	288, 307
369472B	297	36885	274	38820C	128	4009	118
369475	301	36900	303	38830C	128	4010	43
369478B	297	36904	303	38850GEW	128	40107	285
369484B	297	36905	303	388804L	129	40108	285
369550B	297	36908	303	38882G	128	40109	285
369551B	297	36909	303	38883G	128	40110	258
369552B	297	36910	322	38884G	128	40111	258
369595	302	36911	322	3956	205	40112	258
369670B	298	36917	322	3957	205	40113	258
369674B	298	36940	303	3958	205	40114	258
369724	299	36941	303	3959	205	40115	258
369732	299	36942	303	3960	205	4012	43
369811B	299	36968	302	3961	205	40140	305
369814B	299	36970	301	3970	205	40144	304
369816B	299	36990	301	3971	205	40146	304, 307
369817B	299	36990R	301	3980	205	40147	304, 307
369819B	299	381109LG	126	3981	205	40148	304, 307
369820B	299	381206LG	126	3990	205	40150	260
369824B	299	3812CH	196	3991	205	40152	260
369832	299	3812CM	196	3992	205	40153	259
3633	305	3812MP	196	3993	205	40154	259
36333	267	3816CH	196	40000	256	40155	259
36334	267	3816MP	196	40001	256	40156	259
36396	263	3816WH	196	40002	256	40157	259
36399	282	3816	211	40003	256	4016	43
36400	282	3817	211	40004	256	40164	201
36439	305	38180A	196	40005	256	40180	259
36490	294	3820CH	196	40006	256	4020	43
36505	269	3820MP	196	40007	256	40210	289
36552	259	38240A	196	40008	256	40220	289
36567	287, 307	38310	126	40010	256	40224	290
36568	287, 307	38322BH	138	40020	266	40225	289

PRODUCT INDEX

Prod No	Page No	Prod No	Page No	Prod No	Page No	Prod No	Page No
40227	289	40395	199	40710	265	4260	207
40230	289	40396	199	40711	265	4261	207
40232	289	40397	199	40712	265	4270	207
40233	289	40398	199	40713	265	4271	207
40236	304	40399	199	40724	284	43000	15
40237	304	40400	199	40725	284	43002	15
40261	291	40401	199	40728	262	43004	15
40262	291	40402	199	40729	262	43006	15
40267	291	40403	200	40731	292	43008	15
40271	291	40405	200	40732	292	43010	15
40275	291	40412	201	40733	292	43012	15
4029	43	40413	263	40735	292	43016	15
40290	264	40415	257	40737	292	43018	15
40291	264, 271	40422	283, 306	410	58	43024	15, 82
40293	264, 271	40423	283, 306	41020	289-290	43030	15
40294	264	40424	305	41027	270-271	43032	15
40300	301	40425	305	41076	211	43034	15
40301	301	40430	284, 306	41076-1	211	43036	15
40305	301	40460	257	41077	211	43038	15
40306	301	40461	257	41077-1	211	43040	15
4033	46	40462	257	41082	274	43042	15
4034	46	40465	257	41083	274	43050	15
40340	302	40466	257	4109	118	4306	147, 197
40345	300	40467	257	41093	304, 307	43066	49
40347	208	40468	257	41169	258	43068	49
40349	208	40480	271	412	58	43080	15
4035	46	40481	271	41225	274-275, 289	43082	15
40350	208	40485	271	41226	289	43086	15
40351	208	40500	268	41270	262	43121	61
40352	208	40501	268	41291	289	43122	61
40353	208	40521	193, 256	41323	285, 306	43123	61
40354	208	40529	261	41349	276	43125	60
40355	208	40532	261	41350	276	43126	61
40356	208	40541	268	41352	276	43141	202
40359	208	40542	268	41354	276	43142	202
40361	208	40545	268	414	58	43143	202
40362	208	40546	268	41506	257	43144	202
40370	198	40561	279, 306	41520	264	43145	202
40371	198	40562	279, 306	41567	286, 307	4315	202
40372	198	40564	279, 306	41568	286, 307	4322	204
40373	198	40565	279, 306	41664	302	4324	204
40374	198	40634	276	41672	294	4326	204
40375	198	40650	274	41673	294	4328	204
40376	198	40670	265	41679	277	4329	204
40377	198	40671	265	41680	277	4330	204
40378	199	40672	265	41683	277	43304	24
40379	199	40673	259	41880	278, 306	43306	24
40380	198	40674	262	41881	278, 306	43308	24
40390	200	40675	262	4206	118	4332	197
40391	200	40676	262	4230	207	43404	24
40392	200	40681	210	4231	207	43410	24
40393	200	40682	210	4250	207	43420	24
40394	200	40683	210	4251	207	43422	24

PRODUCT INDEX

Prod No	Page No	Prod No	Page No	Prod No	Page No	Prod No	Page No
43500	19	43662	47	43983	157	44430	83
43501	19	43663	47	43984	158	44432	83
43503	19	43664	47	43986	158	44432C	83
43504	19	43665	47	43988	157	44460	83
43505	19	43666	47	43989	157	44462	83
43512	19	43668	47	439945200	44	44462C	83
43514	19	43674	47	44010	249	4450	119
43516	19	4370	204	44010SKD	249	44514	81
43520	19	4370-5	204	44011	249	44518	81
43521	19	4371	204	44011SKD	249	44520	81
43522	19	43737	84	44012	249	44522	81
43525	19	43738	84	44030	64	44524	81
43528	19	43739	84	44031	64	44532	68
43529	19	43743	206	4410	119	4460	119
43531	19	43744	206	4411	119	4470	119
43532	19	43745	84	44131	209	4471	119
43533	19	43772	84	44132	209	4512	31, 49
43540	19	4380	204	44133	209	45222	280, 306
4355	119	4380-5	204	44134	209	45259	290
43560	19	43800	25	44135	209	45267	291
43563	19	43801	25	44136	209	4530	27
4358	204	43803	25	44141	209	4531	27
4360	204	43806	25	44142	209	4532	27
4360-5	204	4381	204	44143	209	4533	27
4361	204	4381-5	204	44144	209	4534	27
4362	204	43813	25	44145	209	4535	27
43620	45	43814	25	44146	209	45411	271
43621	45	43822	25	4415	211	45463	260
43622	45	43840	84	4416	211	4549	62
43623	45	43842	84	4420	119	45493	260
43624	45	43850	23	4421	119	4550	62
43625	45	43852	23	4425	211	4551	62
43626	45	43854	23	4426	211	4552	62
43627	45	43856	23	4430	119	4553	60
43628	45	43858	23	4431	119	45571	265
43629	45	43860	23	44400	82	4560	62
43630	45	43862	23	44400C	83	4563	62
43631	45	43864	23	44402	82	45643	277
43633	47	43866	23	44402C	83	45649	277
43635	47	43868	23	44404	82	4571	63
43635L	55	43872	23	44406	82	4572	63
43636	47	4390	204	44410	82	4573	63
43636L	55	4390-5	204	44410C	83	45733	270
43637	47	4391	204	44412	82	4575	63
43638	47	43937	40	44414	82	45772	264
4364	197	43942	59	44414C	83	45779	265
43640	47	43943	59	44416	82	45781	262
43647	42	43944	59	44416C	83	45850	291
43648	42	43965	49	44418	82	4606	118
43649	42	43965L	55	44418C	83	4609	118
43651	42	43980	157	44420	83	4650	63
43653	42	43981	157	44422	83	4651	63
43655	42	43982	157	44422C	83	4709	118

PRODUCT INDEX

Prod No	Page No	Prod No	Page No	Prod No	Page No	Prod No	Page No
4712	118	5216-2	40	53771822NH064	73B	55524	78
4806	118	52163550D	41	53771822NH076	73B	55526	78
4900	211	52163550E	41	53771822NH147	73B	55528	78
49110-1	201	52163841A	41	53771822NH148	73B	55530	78
49112-1	201	52163841F	41	53771822NH414	73B	55532	78
49116-1	201	5216841C2	41	53771822NH512	73B	55534	78
49122-1	201	5216C203	41	53771822NH515	73B	55536	78
4921	205	5216IB203	41	53771822NH630	73B	55538	78
4922	205	5216RB203	41	53781717NM	73	55540	78
4923	205	5220	40	53782020NM	73	55542	78
4924	205	5220-2	40	53785252SM	73	55544	78
4925	205	52203550	41	537852AITM	73	55546	78
4926	205	52203550A	41	53785454SM	73	55550	78
4928	205	52203841B	41	537854AUTM	73	5570	51
4929	205	52203841G	41	53785858SM	73	5573	51
4930	205	5220841C2	41	53787272SM	73	5583	51
4931	205	5220C203	41	537876RM	73	5587	51
49500	39	5220IB203	41	537890RM	73	5601	36
49501	39	5220RB203	41	53931717NM	73	5602	36
49502	39	5224	40	53932020NM	73	5603	36
49503	39	52243550G	41	53935252SM	73	5609	36
49504	39	52243550H	41	54001	8	5610	36
49505	39	52243841C	41	54002	8	5612	36
49506	39	52243841H	41	54003	8	5614	36
4961	205	5224841C2	41	54004	8	5616	36
4962	205	5224C203	41	54005	8	5640	37
4963	205	5224IB203	41	54006	8	5641	37
5CC118MP-12	75	5224RB203	41	54007	8	5642	37
5CC120MP-12	75	5232	40	54018	8	5643	37
5CC200PC-12	75	5232-63550J	41	54019	8	5644	36
5CC55PC-12	75	5232-63550I	41	5501	40	5645	37
5CCCCCLIP-12	75	52323841D	41	5501-2	40	5646	36
5CCLCLIP-12	75	52323841I	41	5505	44	5647	37
500B	29	5232841C2	41	5506	40	5648	37
500M	29	5232C203	41	5506-2	40	5649	37
5024CE29AF010	74	5232IB243	41	5506L	55	5650	37
5024CE29AF014	74	5232RB203	41	5508	44	5651	37
5024EG29AF010	74	52412L	55	5509	44	5652	37
5024EG29AF014	74	53582020NH	73	5512	44	57285252SM012	74
5024FW29AF010	74	53585252SH	73	5517	44	575B	29
5024FW29AF014	74	535890RH	73	5519	44	575M	29
509	119	53761822NH001	73B	5526	40	5806	42
5105-2	46	53761822NH010	73B	5526-2	40	5808	42
5108-2	46	53761822NH014	73B	5529	40	5810	42
5109-2	46	53761822NH512	73B	5529-2	40	5810L	55
5109L	55	53761822NH515	73B	5532	40	5812	42
5116-2	46	53771822NH001	73B	5532-2	40	5812L	55
5120	46	53771822NH004	73B	5536	50	5814	42
51515252SM001	74	53771822NH008	73B	5538	50	5816	42
5212	40	53771822NH014	73B	5540	50	5818	42
5212-2	40	53771822NH023	73B	5544	50	5820	42
5212L	55	53771822NH052	73B	55520	78	5822	42
5216	40	53771822NH062	73B	55522	78	5822L	55

PRODUCT INDEX

Prod No	Page No	Prod No	Page No	Prod No	Page No	Prod No	Page No
5832.....	42	60300-24	203	60712RS.....	181	608132.....	223
5865.....	157	60300-30	203	607130C.....	223	608134.....	223
59035252SM382.....	74	60300-40	203	607120C.....	223	608136.....	223
59085252SM625.....	74	60300-6	203	607120CS.....	223	608142.....	223
5933.....	25, 84	60300-8	203	607122	223	608144.....	223
600295.....	100	60306.....	186	607122P.....	223	608146.....	223
600296.....	100	6031.....	207	607124	223	608162.....	223
601000.....	184	60322.....	188	607124P.....	223	608164.....	223
60100PC.....	183	60324.....	188	607126	223	608166.....	223
601001.....	184	60344.....	186	607130CS.....	223	608192.....	223
601002.....	184	60345.....	186	607132	223	608194.....	223
601003.....	184	60346.....	186	607134	223	608212.....	144
60101.....	183	604144.....	187	607136	223	608236.....	223
60102.....	183	604174.....	187	607140C.....	223	608530.....	144
601028.....	184	604310.....	202	607140CS.....	223	608600.....	144
601029.....	184	604358.....	203	607142	223	608901.....	162
60103.....	184	604359.....	203	607144	223	608902.....	162
601031.....	184	604360.....	203	607146	223	608904.....	162
601306.....	189	604361.....	203	607160C.....	223	608905.....	162
601526.....	207	604370.....	203	607160CS.....	223	608907.....	162
601527.....	207	604371.....	203	607162	223	608908.....	162
601528.....	207	604380.....	203	607164	223	608909.....	162
601529.....	207	604381.....	203	607166.....	223	608913.....	162
601642.....	189	604390.....	203	607190C.....	223	608918.....	162
601647.....	189	604392.....	203	607190CS.....	223	608919.....	162
601824.....	189	604460.....	100	607192.....	223	608924.....	29
601825.....	189	604606.....	100	607194.....	223	609001.....	100
601826.....	189	604609.....	100	607230C.....	223	609002.....	100
601828.....	189	606040.....	197	607232.....	223	609003.....	100
601829.....	187	606055.....	197	607236.....	223	609005.....	100
601830.....	187	606086.....	197	607550.....	210	609006.....	100
601834.....	187	606106.....	147	607552.....	210	609007.....	100
601837.....	187	606902.....	187	607556.....	210	609009.....	100
601840.....	187	606903.....	187	607560.....	210	60907C.....	185
601922.....	186	6070A.....	222	607562.....	210	60907RS.....	181
601923.....	186	607000C.....	223	607566.....	210	60907SERS.....	180
602164.....	187	607000CS.....	223	607680.....	101	60907XRS.....	180
602164C.....	187	607000H.....	223	607682.....	101	60908C.....	185
602164P.....	187	607001.....	223	607683.....	101	60908RS.....	181
602202.....	230	607002.....	223	607685.....	101	60908SERS.....	180
602203.....	230	607002D.....	230	607687.....	101	60908XRS.....	180
602400.....	61	607002P.....	223	607690.....	101	609082.....	98
602424.....	188	607004.....	223	607691.....	101	609083.....	98
602500.....	61	607004P.....	223	607692.....	101	609084.....	98
60275.....	206	607006.....	223	607693.....	101	609085.....	98
60277.....	206	607006P.....	223	607695.....	101	609086.....	98
60278.....	206	60700HL2.....	223	607697.....	101	609092.....	98
60279.....	206	60700HL4.....	223	608002.....	223	609093.....	98
60280.....	184, 206	60700HL6.....	223	608004.....	223	609094.....	98
60300-10	203	60700HLC.....	223	608006.....	223	609096.....	98
60300-12	203	60708RS.....	181	608122.....	223	609097.....	98
60300-16	203	6071A.....	222	608124.....	223	60910C.....	185
60300-20	203	60710RS.....	181	608126.....	223	60910RS.....	181

PRODUCT INDEX

Prod No	Page No	Prod No	Page No	Prod No	Page No	Prod No	Page No
60910SERS	180	61130C	185	64005	9	6914	94
60910XRS	180	61200	182	64007	9	6917	94
609106	146	61200C	185	64009	9	6919	94
609107	145	61210	182	6401	201	6931	94
609109	145	61210C	185	64013	9	6942	94
609110	145	61212	182	64015	9	6947	94
60912C	185	61216	182	64017	9	6954	28
60912RS	181	61216C	185	64018	9	6956	28
60912SERS	180	61220	182	64020	9	6963	90
60912XRS	180	61220C	185	64021	9	6966	90
609131	68	61224	182	64022	9	6982	92
609132	68	61224C	185	64023	9	6982L	92
609133	68	61232	182	6413	163	6984	92
60914C	185	61232C	185	6416	163	6984L	92
60914RS	181	61240	182	6417	163	69844	92
60914SERS	180	61240C	185	6426	163	69846	92
60914XRS	180	61260	182	6439	163	6986	92
609143	144	61260C	185	6450	163	6986L	92
609144	144	61280	182	650B	29	69864	92
609145	144	61280C	185	650M	29	6988	92
609146	145	61302	183	6504	65	69866	92
609147	145	61302C	185	6524	65	6990	92
609170	105	61305	183	6526	65	7000	48
609171	98	61305C	185	6527	65	7006	31
609172	98	61308	183	6528	65	7008	31
609173	98	61308C	185	6529	65	7038	117
609179	69	614	157	6531	90	7039	117
609183	69	614PC	157	6532	90	70900	48
609190	147	614R	157	6534	90	70901	48
609191	147	615	157	6550	64	70902	48
609193	147	61702	183	6551	64	70903	48
609196	98	61702C	185	6552	64	70904	48
609201	97	61704	183	6553	64	70905	48
609202	97	61704C	185	6555	64	7110	69
609203	97	61707	183	6600	123	7111-4	69
609204	97	61707C	185	6601	123	7112	69
609208	97	61708	183	6605	123	7206	96
609209	97	61708C	185	6606	123	7208	96
60921	184	61710	183	6608	123	7210	96
609211	97	61710C	185	6611	123	7212	96
609215	97	61905	183	6620	123	7215	96
609216	97	61905C	185	6621	123	7218	96
609270	53	61907	183	6625	123	7223	96
609273	53	61907C	185	6713	91	7325	95
609310	103	6302FMT	154	6716	91	7400	31
609316	103	630FMT	154	6723	91	7405	31
60934	184	63910L	55	6726	91	7410	31
61115	182	63912L	55	6843	99	7420	31
61120	182	6400	201	6863	99	7550	135
61120C	185	64001	9	6904	28	7555	135
61125	182	64002	9	6907	28	7670	124
61125C	185	64003	9	6908	94	7671	124
61130	182	64004	9	6909	94	7711	121

PRODUCT INDEX

Prod No	Page No	Prod No	Page No	Prod No	Page No	Prod No	Page No
7721	121	9052	124	CC2243	311	CT1217	155
7725	121	9148	124	CD2036	311	CT1418	155
7900	89	9160	124	CH03	139	CT1713TR	155
7901	89	9172	124	CH15	139	CW6C	244
7910	88	9224	124	CM1012	27, 114	DL1826	176
7913	88	9248	124	CM1013	27, 114	DL300	176
7914	88	9260	124	CM1017	115	DL300R	176
7916	88	9272	124	CM10238Z	112	EAG01	86
7918	88	9710	124	CM10239Z	112	EAG02	86
7919	88	9712	124	CM10240Z	112	EAG04	86
7920	88	9720	124	CM10278Z	112	EAG05	86
7924	81	9722	124	CM10279Z	112	EAG06	86
7926	81	ADD4	314	CM10280Z	112	EAG07	86
7928	81	ADD6	314	CM1030	114	EAG08	86
7930	85	ADDC	314	CM10318Z	112	EAG09	86
7932	85	ADDD	314	CM10319Z	112	EAG10	86
7934	85	ADDR	314	CM1032	114	EAG11	86
7940	24	ADS4	314	CM1033	114	EP10	30
7942	24	ADS8	314	CM1033P	114	EP100	38
7944	81	ADSC	314	CM1035	114	EP20	30
7946	81	ADSD	314	CM1037	114	EP214	142
7948	81	ARR112	84	CM1040	113	EP215	142
800B	29	ARR120	84	CM1042	113	EP216	142
800M	29	ARR240	84	CM1042LP	113	EP217	142
8004	49	BC05	140	CM1043	113	EP30	53
8038	95	BIN27	231	CM1045	113	EP320	142
8099	95	BIN27L	231	CM1046	113	EP40	38
8100	95	BIN36	231	CM1049	113	EP50	38
8104	49	BIN36L	231	CM1050	115	EP60	38
8110	93	BIN44	231	CM1058	115	EP70	38
8112	93	BIN44L	231	CM1065	115	EP90	38
8302FMT	154	C111	244	CM1069	115	GA55001	12
830FMT	154	C135	244	CM1100	111	GA55002	12
8508	93	C2220A	245	CM1100C14	108	GA55003	12
8819	93	C2222A	245	CM1101	111	GA55005	12
8821	93	C2222C	245	CM1101C14	108	GA55006	12
8886	91	C2222HD	245	CM1102	111	GA55007	12
8887	91	C2236	245	CM1102C14	108	GA55008	12
8888	91	C2236H	245	CM1103	111	GA55009	12
8910	88	C2237	245	CM1103C14	108	GA55010	12
8919	88	C32P1	244	CM1104	111	GA55011	12
8920	88	C32P2	244	CM1104C14	108	GA55012	12
91020	32	C35P	244	CM1105	111	GA55013	12
91040	32	C3620W	163	CM1105C14	108	GA55014	12
91055	32	C3625	163	CM1107	110	GR09	142
91065	32	C3625T	163	CM1108	110	GR10	142
91070	32	C3630W	163	CM1125	111	Group A	33
91075	32	C93	244	CM1126	111	Group AT	33
91080	32	CC11SH	311	CM1127	111	Group B	33
91085	32	CC11TH	311	CM1128	111	Group BT	33
91090	32	CC2036	311	CP2036	311	Group C	33
91095	32	CC2036DP	311	CT1014	155	Group CT	33
9051	124	CC2036P	311	CT1216	155	Group D	33

PRODUCT INDEX

Prod No	Page No	Prod No	Page No	Prod No	Page No	Prod No	Page No
Group DT.....	33	IC2250T.....	177	N44012.....	248	PS602N.....	137
Group E.....	33	IC2254.....	177	OP304.....	143	PS603N.....	137
Group ET.....	33	IG1011.....	146	OP305.....	143	PS701B.....	137
Group P1.....	33	IG224.....	146	OP311.....	143	PS702.....	137
Group P1T.....	33	IT1000.....	168	OP314.....	143	PS801B.....	137
Group P2.....	33	IT140.....	169	OP316.....	143	PS802.....	137
Group P2T.....	33	IT160.....	169	OP371.....	143	PSD13CH.....	99
Group P3.....	33	IT180.....	169	OP373.....	143	PSD13EH.....	99
Group P3T.....	33	IT250.....	168	OSB172.....	96	PSD21CH.....	99
Group P4.....	33	IT400.....	169	OSB176.....	96	PSD21DEH.....	99
Group P4T.....	33	IT410.....	169	OSB178.....	96	PSD21EH.....	99
HAL01.....	10	IT500.....	168	P614.....	157	RB.....	242
HAL02.....	10	JC1945CB.....	317	P614R.....	157	RC16.....	243
HAL03.....	10	JC1945L.....	317	PAR19.....	13	RC16-1.....	243
HAL04.....	10	JC1945S.....	317	PAR20.....	13	RC20.....	243
HAL05.....	10	JC1946.....	317	PAR22.....	13	RC20-1.....	243
HAL06.....	10	KL102.....	21	PAR23.....	13	RDC.....	245
HAL09.....	10	KL108.....	21	PAR24.....	13	RDC1.....	245
HAL10.....	10	KL115.....	21	PC140N.....	175	RE.....	238-242
HAL11.....	10	KL116.....	21	PC160N.....	175	RE16.....	239
HAL12.....	10	KL118.....	21	PC180N.....	175	RE16C.....	239
HAL13.....	10	KL119.....	21	PC300N.....	175	RE25.....	240
HAL14.....	10	KL121.....	21	PC600N.....	175	RE25C.....	240
HAL15.....	10	KL123.....	21	PC660.....	174	RE36.....	241
HAL16.....	10	KL126.....	21	PCD205.....	26	RE36C.....	241
HAL17.....	10	KL127.....	21	PCD206.....	26	RE49.....	241
HAL18.....	11	KL200.....	21	PCD207.....	26	RE49C.....	241
HAL20.....	11	KL201.....	21	PCD209.....	26	RE9.....	238
HAL21.....	11	KL203.....	21	PCD210.....	26	RE9C.....	238
HAL22.....	11	KL204.....	21	PCD211.....	26	REW20S.....	237
HAL23.....	11	KL205.....	21	PCD220.....	26	REW20SC.....	237
HAL24.....	11	KL350.....	21	PCD305.....	26	REW30S.....	237
HAL26.....	11	KL444.....	158	PCD308.....	26	REW30SC.....	237
HAL27.....	11	KL800.....	21	PCD310.....	26	RF.....	242
HAL28.....	11	KL805.....	21	PCD312.....	26	RFP.....	243
HAL31.....	11	KL920.....	21	PCD313.....	26	RG16.....	239
HAL32.....	11	KL924.....	21	PCD316.....	26	RG16-1.....	239
HL7237.....	195	KL928.....	21	PCD319.....	26	RG16-1C.....	239
HL7237PS.....	195	LB10.....	95	PCD412.....	26	RG16-2.....	239
HL8185.....	195	LB12.....	95	PCD796.....	26	RG16-2C.....	239
HL8185B.....	195	LB16.....	95	PCD801.....	158	RG16-3.....	239
HL8185C.....	195	LD1000N.....	173	PS101CS.....	140	RG16-3C.....	239
HL8185G.....	195	LD250N.....	173	PS103.....	137	RG16-4.....	239
HL8185GB.....	195	LD350N.....	174	PS103AT.....	137	RG16-4C.....	239
HL8185GC.....	195	LD500N.....	173	PS203.....	137	RG16-5.....	239
HL8195.....	195	LD500NSS.....	174	PS204.....	136	RG16-5C.....	239
HL8195B.....	195	MIN5440.....	38	PS204AST.....	136	RG25.....	240
HL8285.....	195	MIN5441.....	38	PS304.....	137	RG25-1.....	240
HL8285B.....	195	MIN5442.....	38	PS304AT.....	137	RG25-1C.....	240
HL8285G.....	195	MIN5443.....	52	PS501N.....	137	RG25-2.....	240
HL8285GB.....	195	MIN5445.....	52	PS502N.....	137	RG25-2C.....	240
HLA20.....	195	MIN5449.....	38	PS6012.....	137	RG25-3.....	240
IC2220.....	177	N44010.....	248	PS601N.....	137	RG25-3C.....	240
IC2250.....	177	N44011.....	248	PS601NC.....	136	RG25-4.....	240

PRODUCT INDEX

Prod No	Page No	Prod No	Page No	Prod No	Page No	Prod No	Page No
RG25-4C	240	RW30-1C	237	SMR12	104	UC5031524	312
RG25-5	240	RW30-2	237	SMR16	104	UC5031827	312
RG25-5C	240	RW30-2C	237	SMR1624	104	UC5032135	312
RG36	241	RW30-3	237	SMR1836	104	UC7022133	312
RG36-1	241	RW30-3C	237	SMR24	104	UC7031524	312
RG36-1C	241	RW30-4C	237	SMTD16	104	UC7031827	312
RG36-2	241	S275	60	SMTD24	104	UC7032133	312
RG36-2C	241	S277	60	SP18	103	UCC4018	313
RG36-3	241	S279	60	SP22	103	UCC4525	313
RG36-3C	241	S280	60	SPD123	125	UD1726	176
RG36-4	241	S282	60	SPD300	125	WB965	65
RG36-4C	241	S285	60	SPD300KD	125	WPM20	143
RG36-5	241	S286	60	SPD303	125	WPM25	143
RG36-5C	241	S287	60	SPD303KD	125	WPM45	143
RG49	241	S310	58	SS105	139	WPM85	143
RG49-1	241	S312	58	SSD100	129	XB5	170
RG49-1C	241	S314	58	SSW1	102	XDL3000H	176
RG49-2	241	SB66	96	ST1532	227	XT10000	172
RG49-2C	241	SB68	96	ST1544	227	XT1400	171
RG49-3	241	SB70	96	ST1556	227	XT1600	171
RG49-3C	241	SB72	96	ST1568	227	XT1800	171
RG49-4	241	SB74	96	ST1573	227	XT2500	172
RG49-4C	241	SB76	96	ST1587	227	XT3000R	171
RG49-5C	241	SB78	96	ST1629	227	XT5000	172
RG9	238	SB79	96	ST1630	227		
RG9-1	238	SB90	95	TC1826N	175		
RG9-1C	238	SB94	95	TP100	129		
RG9-2	238	SBC11SH	312	TRA01	87		
RG9-2C	238	SBC11TC	312	TRA02	87		
RG9-3	238	SBC1521	311	TRA03	87		
RG9-3C	238	SBC2031	311	TRA04	87		
RG9-4	238	SBC230	312	TRA05	87		
RG9-4C	238	SBCA30000	311	TRA06	87		
RG9-5	238	SBCC240	311	TRA07	87		
RG9-5C	238	SBCC245	311	TRA08	87		
RHC	245	SBCRKIT	311	TRA09	87		
ROP	242	SBG1	102	TRA10	87		
RP	242	SC25	158	TRA11	87		
RPC	243	SC26	158	TRA12	87		
RSP	243	SC27	158	TTH100	329		
RST1520NSQ	159	SC29	158	TTL100	329		
RTP	242	SC32	99	TTL150	329		
RW20	237	SC40	158	TTL580	329		
RW20-1	237	SCL1	102	TTLD580	329		
RW20-1C	237	SD01	102	TTS100	329		
RW20-2	237	SEA1	102	TTS150	329		
RW20-2C	237	SL6011L	102	TTS580	329		
RW20-3	237	SL6011TC	102	UC1940	313		
RW20-3C	237	SMMC10	104	UC3031524	312		
RW20-4C	237	SMMC12	104	UC3031827	312		
RW20-C	237	SMMC8	104	UC4018	313		
RW30	237	SMO1624	104	UC4031529	312		
RW30-C	237	SMO2232	104	UC4031733	312		
RW30-1	237	SMOC24	104	UC4525	313		

1. Terms and Method of Payment

- a. All orders are subject to approval and acceptance by SELLER. No order accepted by SELLER shall be subject to cancellation, termination, suspension, change, reduction, cutback or other modification except with SELLER'S prior written consent.
- b. Our standard terms of payment are net 30 days from invoice date. The amount of terms of credit, if extended, may be changed or credit withdrawn by SELLER at any time. No orders will be shipped on a COD basis.
- c. Prices do not include federal, state or local taxes, duties or other levies, now or hereafter enacted, applicable to the items deliverable under the sales order or invoice (hereinafter called ITEMS), which taxes, duties, or other levies will be added by SELLER to the sales price and will be paid by BUYER unless BUYER provides SELLER with a proper exemption certificate.
- d. Packaging for commercial shipment is included in the contract price. Any special packaging, crating or shipping instructions must be noted on BUYER'S original order and acknowledged by SELLER.

2. Title and Delivery

The ITEMS shall be delivered F.O.B. SELLER'S plant, and title thereto shall pass to BUYER, upon SELLER'S delivery of the ITEMS to a common carrier for shipment to BUYER. All items from the Carlisle FoodService Products catalog may be combined to obtain prepaid freight, regardless of the shipping point. Freight is prepaid on all orders totaling \$2,500 net or more to one destination within the contiguous 48 United States. Freight on prepaid International Shipments will be paid on normal ground transportation from shipping point to the consignee. When the order qualifies for prepaid freight, Seller shall have the right to select the means of transportation. If Buyer requires a means of transportation other than the one normally selected by Seller, any extra cost incurred by reason of using such other means shall be paid by Buyer. Palletized international orders requiring heat treated pallets will be charged \$4.25 net per pallet. International orders requiring heat treated certified bark-free pallets will be charged \$18.50 net per pallet. Any accessorial charges incurred because of a customer request will be the responsibility of the requester. Any items backordered from a prepaid shipment will be forwarded prepaid. Items backordered from ex works shipments will be forwarded ex works.

3. Inspection and Acceptance

Thoroughly inspect all shipments. Do not accept a damaged or short shipment until exception is noted on the freight bill. BUYER will be held responsible for all shipments with freight bills signed free and clear. If concealed damage is discovered, contact the freight company immediately for inspection. Concealed damage must be reported to the carrier within 7 days of receipt. All damaged goods and shortages that are not properly documented and reported upon receipt become the sole responsibility of the BUYER.

4. Patent Indemnification

SELLER shall protect and indemnify BUYER and its directors, officers, agents and employees against all claims for damages or profits, including all reasonable costs incurred by BUYER in connection therewith, arising from infringement of patents, copyrights, trademarks or misappropriation of designs.

5. Returns and Cancellations

No returns will be accepted without an authorization number from Carlisle Customer Service. An authorization number may be obtained by calling 800-654-8210 and requesting a Return Authorization from Customer Service. All requests for return must occur within 90 days of the original shipment of the product unless special authorization is obtained. Merchandise returned without authorization will be refused and returned to the customer, freight collect.

Any merchandise must be returned freight prepaid, and is subject to a minimum of 15% restocking charge.

All returned goods must reference the original invoice and purchase order. Returned goods must be in original standard packs and in unused salable condition. Special Order Products and discontinued items will not be accepted for exchange or return. This includes any articles custom imprinted or modified for purchaser.

6. General

- a. All prices are list and subject to change without notice. Orders from authorized accounts will be accepted with the understanding that prices are those in effect at the time of shipment. These prices are exclusive of all sales taxes which may be levied by State, Federal, or City governments.
- b. Orders less than \$100.00 net will be charged a \$10.00 handling fee. The initial order requirement for a new customer is \$3,500 net, and must be accompanied by a tax exemption certificate.
- c. Orders calling for less than a standard case pack will be charged \$5.00 net each per broken case.
- d. Orders requiring 3rd party freight billing will be accessed a \$5.00 per order processing charge.
- e. All orders of custom products are subject to shipment of plus or minus 10% of the quantity ordered.
- f. No ITEMS to be furnished hereunder shall be exported by BUYER unless SELLER is first notified in writing of the intention to so export and all applicable regulations and licenses are complied with and obtained by BUYER or its customer.
- g. SELLER hereby certifies that the goods described herein of its manufacture will be produced in compliance with all applicable requirements of Sections 6, 7 and 12 of the Fair Labor Standards Act, as amended, and all order of the United States Department of Labor issued under Section 14 thereof. SELLER further certifies that it is in compliance with the Equal Employment Opportunity clause in Section 202, paragraphs 1 through 7 of Executive Order 11246, as amended, relative to equal employment opportunity and the implementing Rules and Regulations of the Office of Federal Contract Compliance.
- h. SELLER is not responsible for typographical errors made in any of its publications or for stenographic or clerical errors made in preparation of quotations, sales orders, acknowledgments, or invoices. All such errors are subject to correction.
- i. This agreement shall be governed by the laws of the state of Oklahoma.
- j. SELLER'S "Terms and Conditions" as set forth above shall govern all transactions. Any inconsistent terms of BUYER wherever set forth and whether oral or written, shall not be binding upon SELLER unless agreed to by SELLER in writing. No waiver or exception to any of the hereinabove enumerated conditions or any of the special terms and provisions relating to any order shall be binding upon SELLER unless agreed to in writing by SELLER.
- k. SELLER reserves the right to change or discontinue the color, design, component content or price of any ITEMS in SELLER'S catalog or published price lists without prior notice at any time.

The specifications and prices listed in this document are subject to change. Carlisle does not assume responsibility for typographical errors.

REV5/14



www.carlislefsp.com

©2017 Carlisle FoodService Products
4711 East Hefner Road
Oklahoma City, OK 73131
Phone: 405.475.5600
Toll Free: 800.654.8210
Toll Free Fax: 800.872.4701
Printed in USA

CAT2017FSP