



# Cleaning Sanitation And Maintenance Professionals Count On Carlisle

**OUR SANITARY MAINTENANCE PRODUCTS (SMP) DIVISION SERVES THE CLEANING AND MAINTENANCE OPERATIONS IN COMMERCIAL BUILDING, INDUSTRIAL AND INSTITUTIONAL FACILITIES AROUND THE GLOBE. THE SPARTA BRAND, FOUNDED IN 1906, IS THE LARGEST COMMERCIAL SANITATION BRUSH MANUFACTURER IN THE UNITED STATES.**

Sparta's Spectrum color-coded system helps customers remain safe and compliant in their food processing and facility sanitation operations. Our cleaning tools and brushes, which include colored bristles classified by use, promote food safety using color-coded work zone applications, minimizing the risk of cross-contamination within your HACCP procedures. Our SMP product offerings are a key part of your integrated program designed to keep your facility clean and well organized.

## **Janitorial Brushes & Cleaning Tools**

Carlisle offers a wide range of ergonomic hand scrubs, maintenance brushes, window cleaning equipment, floor sweeps, brooms, dusters, rotary floor cleaning and maintenance brushes. By adding these to wet mopping systems and restroom cleaning brushes and tools, we have created a full portfolio of professional-grade cleaning tools, which can meet any customer's janitorial and sanitation needs.

## **Food Processing Brushes & Cleaning Tools**

This line includes a HACCP system ready, FDA approved, color-coded line of brushes for cleaning tanks, kettles, valves, QA lab equipment, tygon tubing and elbows and fittings. We offer heavy-duty, color-coded scrapers, mallets and shovels for specific production lines and ingredient handling; comprehensive floor care and sanitation offering; and brushes to clean boots and shoes and hands and nails.

## **Waste Containers & Material Handling**

Rugged construction makes Carlisle's recycling cans, office waste containers, fire-resistant waste baskets, roll-away containers and dollies the obvious choice for your waste handling needs from commercial building to light industrial use. Our color-coded waste containers offer a way to handle different ingredients while avoiding cross contamination.

High quality service carts, janitorial carts, dollies and tilt trucks for the maintenance and janitorial staffs, help reduce the risk of employee injury during transport operations.



*We're proud to be the trusted resource for your janitorial, equipment cleaning, waste handling and transport needs. Turn to the Carlisle catalog to help make your work easier.*

# CATALOG GUIDE



## Brushes & Accessories..... 4-55

- All Purpose Brushes..... 8-15
- All Purpose Wire Brushes..... 16-17
- Food & Beverage  
Production ..... 18-24
- Commercial Foodservice  
Operations ..... 25-39
- Vehicle Brushes..... 40-43
- Window Cleaning ..... 44-47
- Restroom Maintenance ..... 48-49
- Dusters & Accessories ..... 50-51
- Sparta® Spectrum®  
Supermarket Kits..... 52-53
- Plant Sanitation Guide..... 54-55

## Floor Care Products..... 56-149

- Brooms ..... 58-61
- Dustpans ..... 62-63
- Floor Sweeping..... 64-73
- Floor Scrubbing..... 74-77
- Floor Accessories ..... 78-79
- Squeegees..... 80-84
- Mopping ..... 85-97
- Handles..... 98-107
- EZ Snap Floor Care  
System..... 108-111
- Rotary Brushes..... 112-131
- Rotary Brush  
Machine Listings..... 132-145
- Power Sweeping ..... 146-149

## Waste Management & Material Handling..... 150-173

- Waste Containers ..... 152-163
- Tilt Trucks ..... 164-165
- Utility Carts..... 166-171
- Tote Boxes &  
Accessories ..... 172-173

## Reference/Index ..... 174-193

- Handle Guide..... 176-180
- Hot Stamping ..... 180
- Bristle Material Guide..... 181
- Plant Sanitation Guide..... 182-183
- Chemical Brush Tie-In..... 184-185
- Solvent & Chemical Resistance ..... 186-187
- Index..... 188-192
- Terms & Conditions ..... 193

### Section Identification

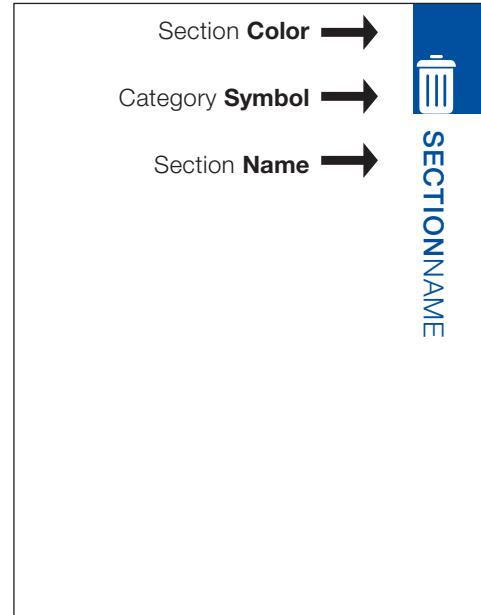

### Category Symbols

 Brushes & Accessories

 Floor Care Products

 Waste Management & Material Handling

 Reference

 Index

product listings on next page »



<b>PRODUCT</b>	<b>PAGE</b>	<b>PRODUCT</b>	<b>PAGE</b>	<b>PRODUCT</b>	<b>PAGE</b>
21 Key Brushes . . . . .	26	Cans, Waste		Equipment Cleaning Brushes	
Boot 'N Shoe Brush . . . . .	17	56 Gallon Container . . . . .	159, 163	Coffee Service Brushes . . . . .	30
Bristle Material Guide . . . . .	181	Bronco Cans . . . . .	152-156, 162	Coil Valve Brushes . . . . .	21
Brooms		Bronco Cans, Hot Stamped . . . . .	155	Dishwasher Machine Brush . . . . .	30
Angle Brooms . . . . .	58	Bronco Cans, Square . . . . .	156	Elbow & Fitting Brushes . . . . .	20
Corn & Synthetic Corn . . . . .	60-61	Centurian . . . . .	158, 162	Grill Bricks, Screens & Polishing Pads . . . . .	33
Duo-Sweep Brooms . . . . .	58-59	Dollies . . . . .	155, 157	High Temperature Brushes . . . . .	27, 38
Lobby Brooms . . . . .	62	Fire Resistant Wastebaskets . . . . .	161	Hot Dog Roller Brush . . . . .	27
Upright Brooms . . . . .	60-61	Office Wastebaskets . . . . .	161, 163	Meat Slicer Cleaner . . . . .	31
Brush Racks . . . . .	107	Recycle Cans, Label Kit . . . . .	163	Oven/Grill Brushes . . . . .	32
Brushes		Rolling Can . . . . .	159, 163	Spout Brushes . . . . .	20
Basting Brushes . . . . .	37	Step-On Containers . . . . .	160	Tank & Kettle Brushes . . . . .	19
Bottle Brushes . . . . .	29	Tilt Trucks . . . . .	165	Vat & Cylinder Brushes . . . . .	18
Carpet & Upholstery . . . . .	15, 79	Tool Caddy (Bronco) . . . . .	157, 163	Vegetable Cutter Brushes . . . . .	30
Clean-In-Place Brushes . . . . .	24	TrimLine Cans . . . . .	8, 108	Waffle & Griddle Cleaning Brushes . . . . .	38
Counter Brushes . . . . .	12-13	Carts & Tilt Trucks		Floor Drain Brushes & Handles . . . . .	78
Cutting Board Brushes . . . . .	25	Fold 'N Go Carts . . . . .	166	Floor Rack System . . . . .	173
Dish Brushes . . . . .	31	Janitor's Cart . . . . .	170-176	Floor Scrapers . . . . .	79
Food Prep Brushes . . . . .	34-37	Service Cart . . . . .	168	Floor Scrubs	
Glass Wash Brushes . . . . .	28	Stainless Steel Carts . . . . .	168	Baseboard Scrubber . . . . .	78
Grout Line Brushes . . . . .	77	Transportation Cart . . . . .	167	Deck Scrubs . . . . .	75
Hand & Nail Brushes . . . . .	14	Tilt Trucks . . . . .	164-165	Dual Surface Scrubs . . . . .	74
Hand Scrubs . . . . .	14-15	Utility Cart . . . . .	169	Scrub Pads & Holders . . . . .	77
Multi-Purpose Brushes . . . . .	19	Caution Cones, Barriers . . . . .	97	Swivel Scrubs . . . . .	76
Pastry Brushes . . . . .	34-36	Ceiling Fan Dusters . . . . .	50	Tile & Grout Scrubs . . . . .	77
Scratch Brushes . . . . .	33	Deck Scrubs . . . . .	75	Floor Squeegees . . . . .	80-84
Upholstery Spot Brushes . . . . .	15	Dollies, Trash Can . . . . .	155, 157	Floor Sweeps	
Utility Scrub Brushes . . . . .	8-11, 43	Drain Brush . . . . .	78	Brushless Mechanical Sweepers . . . . .	63
Vegetable Brushes . . . . .	37	Drain Opener . . . . .	78	Fine Floor Sweeps . . . . .	68
Vehicle Brushes . . . . .	41-43	Duo-Sweeps . . . . .	58-59	Fine/Medium . . . . .	66, 69-70
VersaClean Brushes . . . . .	84	Dust Pans & Combos . . . . .	62-63	Heavy Sweeps . . . . .	72-73
Wand Brushes . . . . .	13	Dusters		Medium Sweeps . . . . .	71
Wire Brushes . . . . .	16-17	Ceiling, Fan & Wall Dusters . . . . .	50	Omni Sweep . . . . .	64, 96
Buckets, Mop . . . . .	87, 96	Feather & Wool Dusters . . . . .	50-51	Ready Sweeps . . . . .	66-67
Bus Boxes, Tote Boxes & Lids . . . . .	172-173			Scraperbroom . . . . .	73
				Sweep Complete . . . . .	65



<b>PRODUCT</b>	<b>PAGE</b>	<b>PRODUCT</b>	<b>PAGE</b>	<b>PRODUCT</b>	<b>PAGE</b>
Floor Machine		Mops & Mopping Accessories		Rotary Brushes	
Brushes . . . . .	see Rotary Brushes	Bucket/Wringer . . . . .	87, 96	Carpet Cleaning Brushes & Accessories . . . . .	121, 126-127
Gripper . . . . .	49	Caution Cones, Barriers . . . . .	97	Clutch Plates & Lugs . . . . .	120, 130-131
Handles & Accessories		Cut-End Mops . . . . .	92-93	Colortech Rotary Brushes . . . . .	112-115
3-Piece Aluminum Handle . . . . .	104	Dust Mops . . . . .	86	Concrete Floor Preparation Tools . . . . .	121, 128-129
Braces & Adapters . . . . .	106	Handles . . . . .	100-101	EZ Snap Floor Care System . . . . .	108-111
Coated Metal Handles . . . . .	104	Looped-End Mops . . . . .	90-92	Machine Listings . . . . .	132-145
Fiberglass Handles . . . . .	103	Microfiber Wet & Dry Mops . . . . .	85, 91	Pad Driver Brushes & Accessories . . . . .	120, 124-125
Flex-All Adapter Handle . . . . .	106	Mop Guide . . . . .	88-89	Polishing Brushes . . . . .	120, 124
Flo-Thru Handles . . . . .	104	Rough Surface Mop . . . . .	91	Rotary Bristle Material Guide . . . . .	117
Handle Guide . . . . .	176-180	Screw Top Mops . . . . .	94	Rotary Brush Guide . . . . .	116
Handle Material Guide . . . . .	98-99	Sponge Mops . . . . .	95	Scrubbing Brushes . . . . .	118-119, 122-123
Microfiber Handles . . . . .	103	Wax Applicator . . . . .	95	Stripping Brushes . . . . .	119, 123
Mop Handles . . . . .	100-101	Wet Floor Signs . . . . .	97	Wood Floor Preparation Tools . . . . .	129
Plastic Handles . . . . .	105	Pails, Cleaning, Disinfecting . . . . .	39	Scrapers, Floor . . . . .	79
Steel Handles . . . . .	104	Power Sweeper & Scrubber Brushes		Scrapers, Paddle . . . . .	22-23
Telescopic Handles . . . . .	105	Bristle Types . . . . .	146	Shovels, Food Safe . . . . .	24
Wood Handles . . . . .	102	Main Brooms . . . . .	146-147	Spatulas/Paddles . . . . .	22-23
Ice Only Containers . . . . .	155	Side Sweep Brushes . . . . .	148-149	Sponges . . . . .	44
Maintenance Brushes		Reference Guide		Squeegees, Floor . . . . .	80-84
All Purpose Wire Brushes . . . . .	16	Bristle Material Guide . . . . .	181	Squeegees, Window . . . . .	46-47
Toothbrush Style Brushes . . . . .	17	Chemical Brush Tie-In . . . . .	184-185	Steri-Pail & Suds-Pail . . . . .	39
Wand Brushes . . . . .	13	Handle Guide . . . . .	176-180	Supermarket Kits . . . . .	52-53
Wire Scratch Brushes . . . . .	79	Hot Stamping . . . . .	180	Sweeper, Mechanical . . . . .	63
Mallet . . . . .	38	Plant Sanitation Guide . . . . .	182-183	Sweeps . . . . .	64-75
Mechanical Sweeper . . . . .	63	Solvent & Chemical Resistance . . . . .	186-187	Swivel Scrubs . . . . .	76
Microfiber Cleaning Solutions		Restroom Maintenance		Tilt Trucks . . . . .	165
Aluminum Mop Head . . . . .	87	Bowl Brushes . . . . .	48-49	Toilet Brushes . . . . .	48-49
Cleaning/Polishing Cloths . . . . .	39	Bowl Mops . . . . .	48-49	Tote Boxes, Bus Boxes & Lids . . . . .	172-173
Dry Mops . . . . .	85	Force Cups . . . . .	49	Trash Cans . . . . .	152-163
Rectangular Pail . . . . .	87			Vehicle Brushes . . . . .	80-83
Telescoping Handle . . . . .	87			Vegetable Brushes . . . . .	128
Wet Mops . . . . .	85, 91			VersaClean Brushes . . . . .	84
Mop Buckets . . . . .	87, 96			Waste Containers . . . . .	152-163
				Window Cleaning Equipment	
				Brushes . . . . .	43
				Squeegees . . . . .	46-47
				Strip Window Washers . . . . .	45
				Window Scrapers . . . . .	44



**CARLISLE**

SANITARY MAINTENANCE PRODUCTS



QUALITY  
PROFESSIONAL  
VERSATILE  
DURABLE  
**BRUSHES &  
ACCESSORIES**

---

*Only Carlisle has the professional grade cleaning tools to help you run a smarter, safer and more profitable operation. Our outstanding product selection offers innovative, hard-working products for everything from general cleaning, vehicle maintenance to restroom care.*



It's All About

# The Details

**Sparta** takes the guess work out of facility maintenance and contamination prevention, helping you identify potential risks at a glance – before they have a chance to become an issue. Our full line of brushes and cleaning tools exceed the industry standards for general cleaning and hygiene as well as FDA Food Codes.

## Superior Craftsmanship

Sparta has been the top choice of discriminating professionals the world over for decades. Our brushes feature the highest quality block and bristle materials for maximum cleaning performance and long life. This legendary craftsmanship and superior bristle retention ensure you are using the best product at the lowest total cost of ownership.



## Quality Since 1905

Established in 1905, Sparta Brush quickly became known as the quality standard in the dairy industry. Since those early days we've continued to build quality and superb craftsmanship into an expanding product line that's no longer just dairy brushes. Sparta now offers a brush for virtually all applications. Our continued commitment to quality has given us the extra measure of cleaning efficiency with the durability you can trust.





# The Right Brush Matters

## Critical Cleaning Issues

Personal Hygiene

Cross-contamination

Physical Contamination

Biological Contamination

## Sanitation & Cleanliness Are Vital

You can't afford anything less than "clean" and there is no compromise when it comes to your standards of sanitation for your facility. That's why we offer the right brush for every job to ensure employee safety and wellness and to protect the reputation of your company.

## A Brush You Can Trust

Is dangerous bacteria building up in critical areas of your operation? Don't put your company's reputation at risk of operational safety or bacterial hazard. Companies have relied on Sparta's high quality and superior knowledge of the industry for over a century. You can trust us to provide a durable, high-quality product designed to meet or exceed your operational demands.

**SPARTA<sup>®</sup>**  
**BRUSH**

# ALL PURPOSE BRUSHES

Only Sparta offers the **widest assortment** of brushes for your general cleaning needs manufactured with **high quality materials** making your job easier.



**TOP SELLER**

## Polyester Bristles

- Color-coded products are made with FDA compliant block and bristles
- Polyester bristles offer excellent chemical resistance and withstand temperatures up to 350°F
- Offered in a variety of colors to support any HACCP Program
- Ergonomic handles are designed for comfort and efficiency



Standard(00)*	White(02)	Black(03)	Yellow(04)	Red(05)
Green(09)	Blue(14)	Orange(24)	Tan(25)	Purple(68)

Prod No	Description	Trim	Bristle	Color	Pack	Cs Wt/Cube
<b>All Purpose Utility Scrub Brushes</b>						
40541	8" Utility Scrub with Polyester Bristles	2"	Medium	02, 03, 04, 05, 09, 14, 24, 25, 68	12 ea	6.80/0.65
40501	20" Utility Scrub with Polyester Bristles	2"	Medium	02, 03, 04, 05, 09, 14, 24, 25, 68	12 ea	9.55/1.15
40545	8" Bent Handle Utility Scrub with Polyester Bristles	1-5/8"	Medium	00*	12 ea	6.30/0.65
40546	8" Utility Scrub with Polyester Bristles	2"	Medium	02	12 ea	8.00/0.65





## Nylon

- Medium Stiff Bristles for tough jobs
- Efficiently designed grip style handle allows for comfortable, efficient cleaning
- Plastic handles are light-weight, break-resistant and soak proof



## Polystyrene

- Medium bristles for general cleaning
- Efficiently designed grip-style handle allows for comfortable, efficient cleaning
- Plastic handles are light-weight, break-resistant and soak proof



Standard(00)	White(02)
--------------	-----------

Prod No	Description	Trim	Bristle	Color	Pack	Cs Wt/Cube
<b>Nylon Bristle Utility Scrubs</b>						
40542	8" Utility Scrub with Nylon Bristles	1-1/2"	Medium	00	12 ea	8.00/0.65
40540	8" Utility Scrub with Nylon Bristles	2"	Medium	00	12 ea	7.52/0.65
40500	20" Utility Scrub with Nylon Bristles	2"	Medium	00	12 ea	8.95/1.17
36620	8" Utility Scrub with Nylon Bristles	2"	Medium	00	12 ea	6.00/0.74
36620L	20" Utility Scrub with Nylon Bristles	2"	Medium	00	12 ea	10.00/1.22
<b>Polystyrene Bristle Scrubs</b>						
45472	9-1/4" Utility Scrub with Polystyrene Bristles	1-5/8"	Medium	02	12 ea	7.00/0.65
45475	20" Utility Scrub with Polystyrene Bristles	2"	Medium	02	12 ea	9.00/1.06



# ALL PURPOSE BRUSHES

## Polypropylene Bristles

- Excellent chemical resistance and withstand temperatures up to 225°F
- Ergonomic handles are designed for comfort and efficiency



Prod No	Description	Trim	Bristle	Color	Pack	Cs Wt/Cube
<b>Polypropylene Bristle Utility Scrubs</b>						
36505	8" Utility Scrub with Polypropylene Bristles	2"	Medium	00, 01, 14	12 ea	5.36/0.74
36505L	20" Utility Scrub with Polypropylene Bristles	2"	Medium	00, 14	12 ea	10.92/1.35
<b>Ergonomic Polypropylene Utility Scrubs</b>						
36506	8" Utility Scrub with Polypropylene Bristles	2"	Medium	03	12 ea	6.68/0.72
36506L	20" Utility Scrub with Polypropylene Bristles	2"	Medium	03	12 ea	9.19/1.25



## Natural Fiber Bristles

- 45463, 45493 have solid hardwood blocks
- 8" & 20" utility scrub brushes available with palmyra or tampico bristles



Standard(00)

Prod No	Description	Trim	Bristle	Color	Pack	Cs Wt/Cube
<b>Natural Fiber Bristle Utility Scrubs</b>						
41003	8" Utility Scrub with Tampico Bristles	1-1/2"	Medium	00	12 ea	6.00/0.65
36509L	20" Utility Scrub with Tampico Bristles	2"	Medium	00	12 ea	10.44/1.22
36513	8" Utility Scrub with Palmyra Bristles	2"	Medium	00	12 ea	5.50/0.70
36513L	20" Utility Scrub with Palmyra Bristles	2"	Medium	00	12 ea	9.30/1.35
45463	8-1/2" Stiff Utility Scrub with Palmyra Bristles	2"	Medium	00	12 ea	7.00/0.70
45493	20" Stiff Utility Scrub with Palmyra Bristles	2"	Medium	00	12 ea	9.30/1.35



# ALL PURPOSE BRUSHES

Counter and radiator brushes are excellent for sweeping up fine particles without leaving scratches. Excellent for use on countertops, equipment, and much more. **Available in a variety of bristle materials for any application.**

## Color-Coded Counter Brushes

- FDA compliant block and bristles
- Soft polyester bristles
- 41372 features DuoSet™ (stapled and epoxy set) for superior bristle retention



## Horsehair & Horsehair Blend

- Provides scratchless dusting of highly polished and delicate surfaces
- Removes fine dust particles in commercial applications

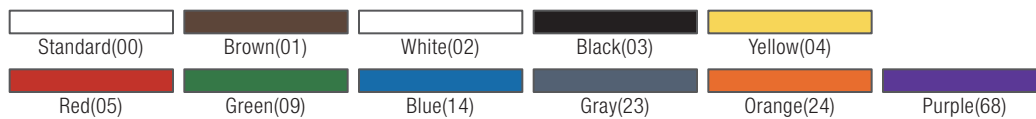

Prod No	Description	Trim	Bristle	Color	Pack	Cs Wt/Cube
<b>Color-Coded Counter Brushes</b>						
40480	8" Counter Brush	2-1/2"	Soft	01, 02, 04, 05, 09, 14, 24, 68	12 ea	7.66/1.35
41372	8" DuoSet Counter Brush	2-1/2"	Soft	02, 03, 04, 05, 09, 14	12 ea	9.00/1.35
<b>Horsehair &amp; Horsehair Blend Brushes</b>						
36380	9" Counter Brush with Horsehair Bristles	3"	Soft	03	12 ea	9.50/1.29
36150	8" Counter Brush with Horsehair Blend Bristles	2-1/8"	Soft	00	12 ea	8.50/1.29
36225	8" Counter Brush with Horsehair Blend Bristles	2-1/2"	Soft	03, 23	12 ea	9.00/1.29
40485	8" Counter Brush with Horsehair & Polypropylene Bristles	2-1/2"	Soft	00	12 ea	9.00/1.35



## Natural/Synthetic Counter Brushes

- Big selection of synthetic fiber for dusting up sawdust, glass particles and everything in between
- 36211's flagged polypropylene bristles are ideal for fine particles, dust, and sawdust on smooth surfaces
- 36259's natural tampico bristles are ideal for light and medium duty tasks



## Wand Brush

- Long narrow profile for hard to reach places and soft bristles for dusting fine particles
- 41198 color-coded is made with FDA compliant block and bristles

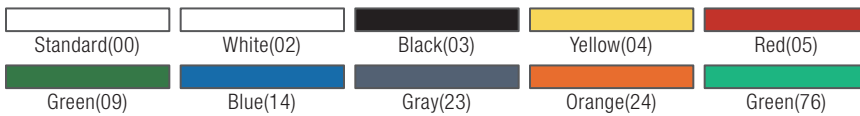

Prod No	Description	Trim	Bristle	Color	Pack	Cs Wt/Cube
<b>Natural &amp; Synthetic Bristle Counter Brushes</b>						
40481	8" Counter Brush with Polyester Bristles	2-1/2"	Soft	00	12 ea	9.00/1.35
36258	8" Counter Brush with Polypropylene Bristles	2-1/2"	Soft	03	12 ea	5.00/1.35
36211	8" Counter Brush with Flagged Polypropylene Bristles	2-1/2"	Soft	23, 24	12 ea	9.00/1.37
36846	8" Counter Brush with Nylex Bristles	2-1/2"	Soft	76	12 ea	8.50/1.29
36259	8" Counter Brush with Tampico Bristles	2-1/2"	Medium	03	12 ea	9.50/1.05
<b>Wand Brushes</b>						
41198	24" Wand Brush with Polyester Bristles	2-1/4"	Medium	02, 04, 05, 09, 14	12 ea	4.75/0.34
36122	24" Radiator/Vent Brush with Flagged Styrene Bristles	1-3/4"	Soft	03	12 ea	3.96/0.32
45411	24" Narrow Radiator Brush with Horsehair-Polypropylene Bristles	1-3/4"	Soft	03	12 ea	4.10/0.33

# ALL PURPOSE BRUSHES

40021

## Hand & Nail Brushes

- Designed to promote vital cleansing of hands for foodservice personnel
- 40020 has stiffer center bristles for a more thorough cleaning under fingernails and longer bristles along the sides clean finger's top and bottom
- 40021 kit includes 5" x 2" brush, cord to secure brush in place, hanging hook and an adhesive backed hand washing instructions decal in English and Spanish
- 45500 is great for use in shop or industrial settings



36239



45500



40020

## Ergonomic Hand Scrub

- Ergonomic handles are designed for comfort and efficiency
- 40520 and 40521 are made with FDA compliant block and bristles



40520  
40521



Prod No	Description	Trim	Bristle	Color	Pack	Cs Wt/Cube
<b>Hand &amp; Nail Brushes</b>						
36239	1-1/2" x 3-1/2" Hand & Nail Brush with Polypropylene Bristles	9/16" & 7/16"	Medium	00	24 ea	1.68/0.09
40020	5" Hand & Nail Brush (only) with Polypropylene Bristles	5/8" & 7/8"	Medium	00	12 ea	4.30/0.27
40021	Hand & Nail Brush Kit	5/8" & 7/8"	Medium	00	12 ea	5.45/0.44
45500	1-1/2" x 5" Hand & Nail Brush with Polypropylene Bristles	11/16"	Medium	42	72 ea	10.80/0.47
<b>Ergonomic Hand Scrubs</b>						
40520	6" Hand Scrub with Nylon Bristles	1-3/8"	Medium	00	12 ea	4.90/0.30
40521	6" Hand Scrub with Polyester Bristles	1-3/8"	Medium	02, 04, 05, 09, 14	12 ea	5.20/0.30
365015	6" Curved Back Utility Hand Scrub with Polypropylene Bristles	1-3/8"	Medium	00	12 ea	4.00/0.29
365009	6" Curved Back Utility Hand Scrub with Tampico Bristles	1-3/8"	Medium	00	12 ea	4.62/0.32







### Pointed End

- Comfortable hourglass shape and pointed bristle design for reaching into corners and tight areas
- 45494 color-coded is made with FDA compliant block and bristles



36277

45494

### Iron-Style

- Iron style grip is ergonomically designed for comfort
- 40024 made with polyester bristles for mold and mildew resistance
- 36289 made with polypropylene bristles
- Color-coded products are made with FDA compliant block and bristles



40024

### Handled

- Small, multi-purpose scrub brush
- Color-coded products are made with FDA compliant block and bristles



41395

### Upholstery Spot Brushes

- Designed to effectively work powder/solution into stained carpet



36257WN

36257N

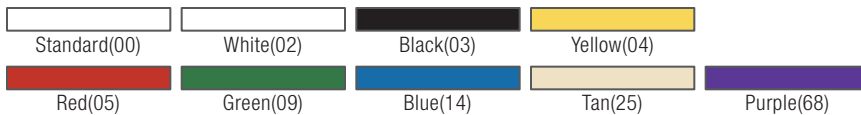

Prod No	Description	Trim	Bristle	Color	Pack	Cs Wt/Cube
<b>Pointed End Hand Scrubs</b>						
45494	8" Pointed End Scrub Brush with Polyester Bristles	1-3/8"	Medium	02, 04, 05, 09, 14	12 ea	5.00/0.44
36277	9" Hand Scrub with Tampico Bristles	1"	Medium	00	12 ea	5.70/0.36
<b>Iron-Style Hand Scrubs</b>						
40024	6" Iron Handle Hand Scrub with Polyester Bristles	1"	Medium	02, 04, 05, 09, 14, 25	12 ea	5.00/0.30
36289	6" Iron-Style Scrub with Polypropylene Bristles	1-1/8"	Medium	00	48 ea	18.24/0.70
<b>Handled Hand Scrubs</b>						
41395	7-1/4" Multi Purpose Hand Scrub with Polyester Bristles	7/8"	Medium	02, 04, 05, 09, 14, 68	12 ea	2.00/0.17
41396	8-1/2" Multi Purpose Hand Scrub with Polyester Bristles	7/8"	Medium	02	12 ea	3.00/0.30
<b>Carpet &amp; Upholstery Spot Brushes – Wood Block</b>						
36257WN	10" Spot Brush with White Nylon Bristles	5/8"	Stiff	00	12 ea	2.82/0.16
36257N	10" Spot Brush with Black Nylon Bristles	5/8"	Stiff	00	12 ea	3.00/0.18



# ALL PURPOSE WIRE BRUSHES

Carbon steel bristles make these heavy duty wire brushes perfect for **removing rust, residue, metal burrs, coatings, paint and varnish.**

## Shoe Handle



## Curved Handle



Standard(00)

Prod No	Description	Trim	Bristle	Color	Pack	Cs Wt/Cube
<b>Shoe Handle Style Wire Scratch Brushes</b>						
45776	10" Wire Brush with 4 x 16 Rows of Carbon Steel Bristles	1-1/4"	Stiff	00	12 ea	5.00/0.18
45777	10" Wire Brush with 4 x 16 Rows of Carbon Steel Bristles and 1-1/2" Scraper	1-1/4"	Stiff	00	12 ea	2.00/0.25
<b>Curved Handle Wire Scratch Brushes</b>						
45770	13-3/4" Brush with 3 x 19 Rows of Carbon Steel Bristles	1-1/8"	Stiff	00	12 ea	5.00/0.24
45773	13-3/4" Brush with Scraper & 3 x 19 Rows of Carbon Steel Bristles	1-1/8"	Stiff	00	12 ea	5.10/0.29



### Toothbrush Style

- Great for small jobs, tight areas, and detail work on ceramic tile, small parts, seams, threads, and soldered joints

#### Stainless Steel

- Wet applications with no rusting

#### Brass

- Light cleaning



### Boot 'N Shoe Brush

- Helps eliminate bacteria, refuse and dirt
- Chrome steel tube frame can be bolted to the floor
- Brushes flip up to expose a steel scraper
- Non-absorbent plastic block with long lasting polypropylene bristles
- FDA compliant block and bristles



Prod No	Description	Trim	Bristle	Color	Pack	Cs Wt/Cube
<b>Toothbrush Style Utility Brushes</b>						
45796	7-1/4" Double-Sided Utility Brush with Brass Wire Bristles	1/2"	Medium	00	36 ea	0.48/0.10
40674	7" Utility Brush with Nylon Bristles	1/2"	Medium	00	12 ea	0.50/0.03
40675	7" Utility Brush with Crimped Stainless Steel Bristles	1/2"	Medium	00	12 ea	0.55/0.02
41270	7" Utility Brush with Brass Bristles	1/2"	Medium	00	12 ea	1.00/0.06
3613B	7-1/4" Utility Brush with Brass Bristles	1/2"	Medium	00	36 ea	1.75/0.09
3613S	7-1/4" Utility Brush with Stainless Steel Bristles	1/2"	Medium	00	36 ea	15.12/0.09
<b>Boot 'N Shoe Brush</b>						
40424	Boot 'N Shoe Brush	—	—	01, 03, 14	1 ea	5.60/1.22
40425	Boot 'N Shoe Brush Replacement	—	—	01, 03, 14	12 ea	17.00/1.33



# FOOD & BEVERAGE PRODUCTION

## Sparta® Spectrum® Tank & Kettle Brushes

- Your trusted source for faster, more effective cleaning of large tanks, kettles and mixers
- Crimped bristles for keeping cleaning solution on the brush
- Use with 60" handles for deep areas
- FDA compliant block and bristles



## Vat & Cylinder Brushes

- Round, dome-shaped brushes are expertly designed for cleaning vats, kettles and valves
- Medium stiff polyester
- FDA compliant block and bristles



Handles sold separately; see pages 176-180 for handle recommendations



Prod No	Description	Trim	Handle	Color	Pack	Cs Wt/Cube
<b>Sparta Spectrum Tank &amp; Kettle Brushes</b>						
41200	Round Tank Brush with Polyester Bristles	2" x 7-1/2"	41296	00	12 ea	12.00/1.89
41296	60" Threaded Stud Plastic Handle	1" Dia	—	00	12 ea	11.26/0.67
40040	Small Flare Head Brush with Nylon Bristles	5-1/2" x 7-1/2"	Threaded	00	12 ea	10.66/1.06
40041	Small Flare Head Brush with Polyester Bristles	5-1/2" x 7-1/2"	Threaded	02, 03, 04, 05, 09, 14	12 ea	12.00/1.06
40042	Large Flare Head Brush with Nylon Bristles	5-1/2" x 9"	Threaded	00	12 ea	15.00/1.28
40043	Large Flare Head Brush with Polyester Bristles	5-1/2" x 9"	Threaded	02, 03, 04, 05, 09, 14	12 ea	18.00/1.28
41220	Jumbo Tanker with Nylon Bristles	6" x 10-1/2"	Threaded	00	12 ea	15.00/1.28
41177	Jumbo Tanker with Polyester Bristles	6" x 10-1/2"	Threaded	02, 04, 05, 09, 14	12 ea	15.00/1.28
<b>Vat &amp; Cylinder Brushes</b>						
41045	Small Vat & Cylinder Brush with Polyester Bristles	5" Dia	Threaded	00	6 ea	3.60/0.44
40045	Medium Vat & Cylinder Brush with Polyester Bristles	6" Dia	Threaded	00	6 ea	4.00/0.56
41002	Large Vat & Cylinder Brush with Polyester Bristles	7" Dia	Threaded	00	6 ea	5.35/1.06



## Atlas Multi-Purpose Brushes

- Medium stiff polyester bristles offer excellent scrubbing power
- Use to clean kettles, vats, pots, tanks or urns
- Available in a variety of sizes and lengths
- FDA compliant block and bristles



## Double End Plug Valve & Fitting Brushes

- This unique brush offers 2 brushes in 1 and is excellent for cleaning valve outlets.
- Stiff polyester bristles tapered at both ends
- FDA compliant block and bristles

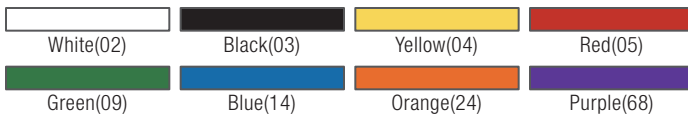

Prod No	Description	Trim	Color	Pack	Cs Wt/Cube
<b>Atlas Multi-Purpose Brushes</b>					
40000	12" Multi-Purpose Bottle/Valve Brush	2-3/4"	02, 04, 05, 09, 14	12 ea	2.40/0.65
40001	16" Multi-Purpose Bottle/Valve Brush	3-1/4"	02, 04, 05, 09, 14, 68	12 ea	5.00/0.65
40002	16" Oval Valve Brush	3-1/2" x 5"	02, 04, 05, 09, 14	6 ea	4.00/0.77
40003	30" Oval Valve Brush	3-1/2" x 5"	02, 04, 05, 09, 14	6 ea	6.75/1.62
40004	16" Round Valve Brush	3" Dia	02, 04, 05, 09, 14	6 ea	3.60/0.65
40006	30" Round Valve Brush	3" Dia	02, 04, 05, 09, 14	6 ea	5.00/1.62
40005	16" Round Valve Brush	4" Dia	02, 04, 05, 09, 14	6 ea	4.55/0.65
40007	30" Round Valve Brush	4" Dia	02, 04, 05, 09, 14	6 ea	5.00/1.62
40010	16" Round Valve Brush	5" Dia	02, 04, 05, 09, 14	6 ea	5.25/1.06
40008	30" Round Valve Brush	5" Dia	02, 04, 05, 09, 14	6 ea	6.75/1.62
<b>Double End Plug Valve &amp; Fitting Brushes</b>					
40679	19" Double End Valve Brush with Polyester Bristles	2-1/4" / 3-3/4"	02	6 ea	2.50/0.77



# FOOD & BEVERAGE PRODUCTION

## Coil Valve Brushes

- Stiff polyester bristles twisted in heavy duty 9 gauge galvanized wire
- Choose straight or L-Tipped style to reach in between the fryer and refrigeration coils
- FDA compliant bristles



## Elbow & Fitting Brushes

- 15" bent or straight brushes expertly designed for cleaning straight pipes, elbows, tees and valves
- Stiff polyester bristles in galvanized wire with plastic handle
- FDA compliant bristles



## Spout Brushes

- Nylon or polyester bristles twisted into flexible wire
- Allows for critical cleaning of bacterial prone taps, spouts, plungers, tubes, equipment fittings, etc.
- FDA compliant bristles

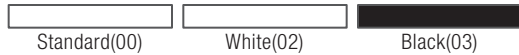

Prod No	Description	Trim	Color	Pack	Cs Wt/Cube
<b>Coil Valve Brushes</b>					
40150	28" Coil Brush with Polyester Bristles	1-3/8" Dia	00	12 ea	5.65/0.36
40152	23" L-Tipped Coil Brush with Polyester Bristles	1-3/8" Dia	00	12 ea	5.10/0.34
<b>Elbow &amp; Fitting Brushes</b>					
40180	Straight Brush with Polyester Bristles	1" Dia	02, 03	12 ea	4.00/0.20
40181	Straight Brush with Polyester Bristles	1-1/2" Dia	02, 03	12 ea	4.00/0.23
40182	Straight Brush with Polyester Bristles	2" Dia	02, 03	12 ea	4.25/0.65
40183	Straight Brush with Polyester Bristles	2-1/2" Dia	02, 03	12 ea	5.00/0.65
41197	Straight Brush with Polyester Bristles	3" Dia	02	12 ea	5.00/0.65
40160	Bent Brush with Polyester Bristles	1" Dia	02	12 ea	4.00/0.23
41196	Bent Brush with Polyester Bristles	3" Dia	02	12 ea	5.00/0.65
<b>Spout Brushes</b>					
40157	5-1/4" Tap Line Brush with Polyester Bristles	1/4"	00	24 ea	0.30/0.05
36552	8" Spout Brush with Nylon Bristles	3/8" Dia	00	144 ea	4.62/0.32
36560	10" Spout Brush with Nylon Bristles	3/4"-1-1/2"	00	72 ea	1.50/0.76
41263	9-1/4" All-Purpose Tube Brush with Nylon Bristles	1/2" & 3/4"	00	12 ea	0.50/0.05
40154	12" All-Purpose Tube Brush with Polyester Bristles	1/2" & 1"	00	24 ea	0.66/0.38
40156	10-1/2" Dispenser Spout Brush with Polyester Bristles	15/16"	00	12 ea	0.85/0.13
40155	13" Dispenser Spout Brush with Polyester Bristles	7/16"	00	12 ea	0.46/0.13



### Tygon Tubing Pipe Brushes

- Sanitary polyester bristles are twisted in flexible galvanized wire to effectively clean tubing
- Designed to clean all types, sizes and lengths of tubing
- FDA compliant bristles

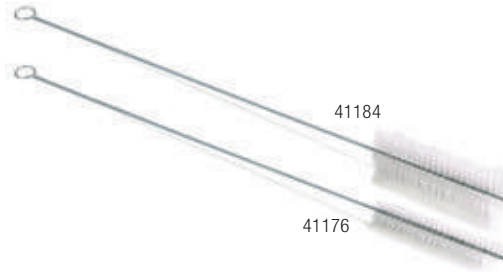

### Medium Duty Pipe Brushes

- For cleaning small tubing, lines and openings
- White, medium polyester bristles with 5" brush part
- FDA compliant bristles

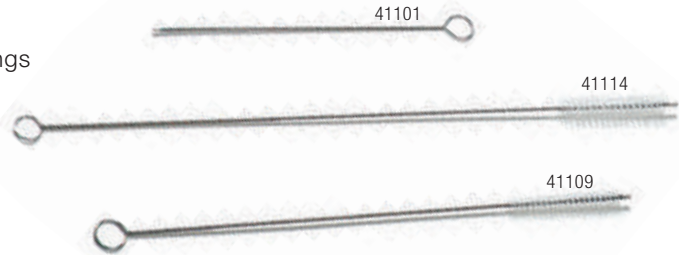

### Heavy Duty Pipe Brushes

- Specially designed to clean inside tubes and pipes
- Medium stiff polyester bristles twisted in 8 gauge wire with a 5" brush part
- FDA compliant bristles



Standard(00)      White(02)

Prod No	Description	Trim	Color	Pack	Cs Wt/Cube
<b>Tygon Tubing Pipe Brushes</b>					
41176	24" Tubing Pipe Brush	1" Dia	02	12 ea	1.50/0.34
41180	72" Tubing Pipe Brush	1" Dia	02	12 ea	3.00/0.76
41184	24" Tubing Pipe Brush	2" Dia	02	12 ea	1.90/0.34
<b>Medium Duty Pipe Brushes</b>					
41101	12" Pipe Brush with Polyester Bristles	1/4" Dia	00	12 ea	1.00/0.13
41102	18" Pipe Brush with Polyester Bristles	1/4" Dia	00	12 ea	1.00/0.28
41105	12" Pipe Brush with Polyester Bristles	3/8" Dia	00	12 ea	1.00/0.13
40176	12" Pipe Brush with Polyester Bristles	1/2" Dia	00	12 ea	1.00/0.13
41109	18" Pipe Brush with Polyester Bristles	1/2" Dia	00	12 ea	1.00/0.28
41110	24" Pipe Brush with Polyester Bristles	1/2" Dia	00	12 ea	1.90/0.34
41114	24" Pipe Brush with Polyester Bristles	3/4" Dia	00	12 ea	1.00/0.34
41160	12" Pipe Brush with Polyester Bristles	1" Dia	00	12 ea	1.00/0.23
41121	24" Pipe Brush with Polyester Bristles	1" Dia	00	12 ea	1.70/0.34
41170	15" Pipe Brush with Polyester Bristles	1-1/2" Dia	02	12 ea	1.90/0.20
41131	18" Pipe Brush with Polyester Bristles	2" Dia	00	12 ea	1.10/0.28
41132	24" Pipe Brush with Polyester Bristles	2" Dia	00	12 ea	2.10/0.34
<b>Heavy Duty Pipe Brushes</b>					
41140	3' Pipe Brush with Polyester Bristles	1-1/2" Dia	00	1 ea	0.06/0.05
41158	3' Pipe Brush with Polyester Bristles	3" Dia	00	1 ea	0.10/0.26
41164	6' Pipe Brush with Polyester Bristles	3" Dia	00	1 ea	3.85/0.59
41271	6" Powder Bag Brush with Nylon Bristles	8" Dia	00	6 ea	3.00/2.11

# FOOD & BEVERAGE PRODUCTION

## Paddle Scrapers

- Perfect for general mixing and stirring
- Smooth finish, water proof construction for easy clean-up
- Standard nylon (300°F) or soft flexible polyethylene (150°F) blades will sharpen and contour to your specific application with usage
- Also available in stainless steel



Prod No	Description	Handle	Color	Pack	Cs Wt/Cube
<b>Paddle Scrapers</b>					
40350	13-1/2" Plastic Handle, 4-1/2" x 7-1/2" Nylon Paddle Scraper	—	02, 04, 05	6 ea	2.75/0.23
40352	40" Plastic Handle, 4-1/2" x 7-1/2" Nylon Scraper	—	02, 04, 05	6 ea	7.00/0.55
40353	48" Plastic Handle, 4-1/2" x 7-1/2" Nylon Paddle Scraper	—	00	6 ea	11.00/0.76
40354	48" Stainless Steel Handle, 4-1/2" x 7-1/2" Nylon Paddle Scraper	—	00	6 ea	15.30/0.76
40356	48" Stainless Steel Handle, 6-1/2" x 9" Nylon Paddle Scraper	—	00	3 ea	8.60/0.76
40355	72" Stainless Steel Handle, 4-1/2" x 7-1/2" Nylon Paddle Scraper	—	00	6 ea	45.00/0.28
41040	72" Stainless Steel Handle, 6-1/2" x 9" Nylon Paddle Scraper	—	00	3 ea	10.88/1.16
40361	4-1/2" x 7-1/2" Nylon Replacement Paddle Scraper Blade	Female Threaded	02	6 ea	1.50/0.10
40362	6-1/2" x 9" Nylon Replacement Paddle Scraper Blade	Female Threaded	00	6 ea	2.65/0.16
40351	13-1/2" Plastic Handle, 4-1/2" x 7-1/2" Polyethylene Scraper	—	00	6 ea	2.65/0.23
40357	40" Plastic Handle, 4-1/2" x 7-1/2" Polyethylene Paddle Scraper	—	00	6 ea	15.00/0.55
41358	48" Plastic Handle, 4-1/2" x 7-1/2" Polyethylene Paddle Scraper	—	00	6 ea	7.15/0.76
41359	60" Plastic Handle, 4-1/2" x 7-1/2" Polyethylene Paddle Scraper	—	00	6 ea	8.85/0.91
40360	4-1/2" x 7-1/2" Polyethylene Replacement Paddle Scraper Blade	Female Threaded	00	6 ea	1.40/0.10
40347 Δ	36" Stainless Steel Paddle Scraper	—	—	6 ea	13.75/0.55
40349 Δ	48" Stainless Steel Paddle Scraper	—	—	6 ea	14.00/0.63
40359 Δ	60" Stainless Steel Paddle Scraper	—	—	6 ea	18.60/0.88
40352	40" Plastic Handle with 4-1/2" x 7-1/2" Nylon Paddle Scraper	—	02, 04, 05	6 ea	7.00/0.55
40350	13-1/2" Plastic Handle with 4-1/2" x 7-1/2" Nylon Scraper	—	02, 04, 05	6 ea	2.75/0.23

NSF Listed products are designated with a Δ and may be prefixed with an N





## Paddle Handles

- Polypropylene handles recommended during lower viscosity uses and lower temperature settings
- Stainless Steel handles are ideal for thick, heavy foods
- Heavy duty, threaded stainless steel handles have plastic grips (end and center) for comfort and heat resistance in high-temp settings
- All handles are female threaded to fit Paddle Scrapers



Soft Polyethylene Paddle Scraper offers greater flexibility, allowing the blade to conform to kettle contours and tight cleaning areas

Standard(00)

Prod No	Description	Color	Pack	Cs Wt/Cube
<b>Paddle Handles</b>				
41447	33" Polypropylene Female Threaded Handle	00	6 ea	4.75/0.55
41448	54" Polypropylene Female Threaded Handle	00	6 ea	7.00/0.88
41449	43" Stainless Steel Female Threaded Handle	00	6 ea	14.50/0.76
41450	67" Stainless Steel Female Threaded Handle	00	6 ea	19.50/0.88

# FOOD & BEVERAGE PRODUCTION

## Clean-In-Place Brushes

- Workhorse construction and durability to increase your labor productivity for this critical sanitation job
- Brushes are ideal for cleaning curved drains, tubes, pipes, and equipment
- Polyester bristles are twisted into galvanized wire
- FDA compliant block and bristles
- 41390 has threaded handle hole; recommend use with 40225 Self-Locking Flex-Tip™ fiberglass handle, sold separately



## Sanitary Shovels

- Heavy-duty one-piece polypropylene construction
- Supports heavy loads, will not rust, and cleans up easily
- Provides the ultimate in scooping large amounts of ice, food, chemicals, and ingredients quickly and easily



Handles sold separately; see pages 176-180 for handle recommendations

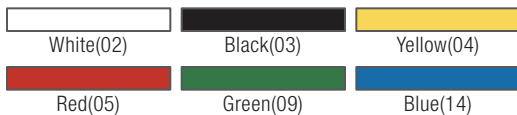

Prod No	Description	Trim	Handle	Color	Pack	Cs Wt/Cube
<b>Clean-In-Place Brushes</b>						
41100	11-1/2" CIP Hook Brush	2-1/4" Dia	—	02, 03, 04, 05, 09, 14	12 ea	5.00/1.06
41390	12" CIP Circular Brush	2" Dia	Threaded	02, 04, 05, 09, 14	12 ea	9.75/1.06
<b>Sanitary Shovels</b>						
41076	11" x 13" Sanitary Shovel	—	—	02, 04, 05	6 ea	19.00/3.16
41077	14" x 16" Sanitary Shovel	—	—	02, 04, 05	6 ea	26.50/5.68

# COMMERCIAL FOODSERVICE OPERATIONS



When it comes to serving, processing or preparation of any food, sanitation and cleanliness are a must. You simply can't afford anything less than "clean". **With Sparta brushes, there's no compromising your standards of sanitation or your quality of food preparation.** Sparta brushes are custom-designed for each specific cleaning, manufacturing process or food preparation.



## Cutting Board Brushes

- Ergonomically shaped handles and crimped stapleset polyester bristles are rugged and will not absorb food oils or moisture
- Segregate brushes and boards by color to help prevent cross contamination
- Color-coded products are made with FDA compliant block and bristles



	Prepared Food, Dry Food & Dairy
	Produce
	Meat
	Fish
	Poultry



White(02)	Yellow(04)	Red(05)
Green(09)	Blue(14)	Tan(25)

Prod No	Description	Recommended Cleaning	Color	Pack	Cs Wt/Cube
<b>Cutting Board Brush</b>					
40521	6" Cutting Board Brush with Polyester Bristles, 1-3/8" trim		02, 04, 05, 09, 14, 25	12 ea	5.20/0.30



# 21 Key Brushes

## Reduce The Risk Of Critical Health Code Violations

You don't want to have to worry about off flavored coffee or contaminated food. The Sparta 21 Key Brush Program eliminates the worry with a package of brushes that every foodservice operation needs.

The Sparta 21 Key Brush Program covers everything from front-of-house to floor care & general cleaning to back-of-house equipment maintenance and food prep as well as restroom care and personal hygiene.

### 21 Key Brush Kit (990021KIT00)



#1



#8



#15



#2



#9



#16



#3



#10



#17



#4



#11



#18



#5



#12



#19



#6



#13



#20



#7



#14



#21

- #1 4037400 • Hot Use
- #2 4040102 • Cold Use
- #3 40405 • Silicone Basting Brush
- #4 4008200\* • 24" Double Foam
- #5 4042302\* • Hi-Lo™ Floor
- #6 3688500 • Duo-Sweep™
- #7 4188100\* • 24" Omni® Floor
- #8 4016402 • Vegetable Brush
- #9 4052102 • 6" Cutting Board Brush
- #10 4054102 • 8" Polyester Scrub Brush
- #11 4050102 • 20" Polyester Scrub Brush
- #12 4067100 • Scratch Brush w/Scraper
- #13 4029000 • Broiler Master
- #14 4011100 • L-Tipped Fryer Brush
- #15 4000002 • 12" Carafe/Bottle Brush
- #16 4002500 • Coffee Decanter Brush
- #17 4014600 • Floor Drain Brush
- #18 4023600 • 36" Plastic Drain Brush Handle
- #19 4014402 • Drain Opening Tool
- #20 4002000 • Hand and Nail Brush
- #21 4014000 • Polyester Bowl Brush

\*Handle Sold Separately - See our Handle Guide on pages 176-180 for handle recommendations

# COMMERCIAL FOODSERVICE OPERATIONS



## Hot Dog Roller Brush

- Ingeniously-designed solution makes tough clean up simple
- Special "V" shaped stiff polyester bristle design cleans hot dog rollers and connecting points at the side walls at one time
- Rids hot dog roller grills of unsanitary grease build-up that could result in mechanical problems



## High Temp Fryer Brushes

- Superior design makes a difficult job easier
- Made of stiff bristles that withstand temperatures up to 500°F
- Saves time since equipment can be cleaned while hot
- Plastic handles stay cool to the touch
- 40110 Fryer Brush is 28" long to reach tight, narrow spaces
- 40112 Looped Brush cleans fryer bottoms easily
- 40111 and 40116 L-Tipped Fryer Brush for cleaning hot coils

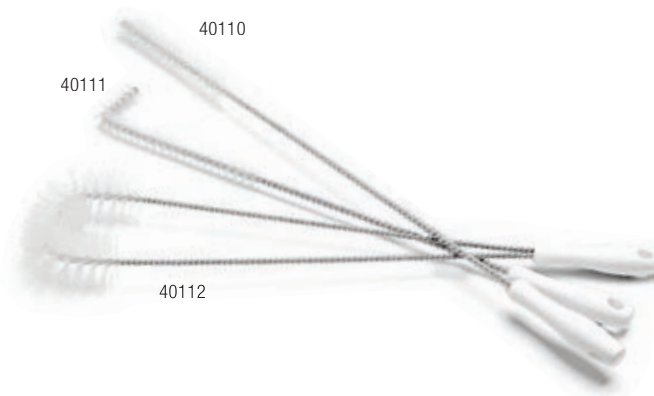

Standard(00)

Prod No	Description	Trim	Color	Pack	Cs Wt/Cube
<b>Hot Dog Roller Brush</b>					
41169	24" L Hot Dog Roller Brush	2"	00	12 ea	6.05/0.34
<b>High Temp Fryer Brushes</b>					
40110	28" Straight Fryer Brush with Bristles	1-3/8"	00	12 ea	5.90/0.34
40112	24" Looped Fryer Brush with Bristles	2"	00	6 ea	3.85/0.34
40111	23" L-Tipped Fryer Brush with Bristles	7/8"	00	12 ea	5.35/0.37
40116	23" L-Tipped Fryer Brush with Bristles	2"	00	12 ea	14.00/1.01

NOTE: Heat coil must be turned off prior to using high temperature brushes

# COMMERCIAL FOODSERVICE OPERATIONS

## Bar Glass Washing Brushes

- Count on Carlisle to deliver sparkling clean bar drinkware
- Pilsner, Hurricane and Standard style glasses can all be cleaned thoroughly and safely with our glass washing brushes
- Heavy-duty polyester bristles with a densely filled dome top hold up to extreme use
- Threaded white plastic stems help prevent glasses from being chipped or broken
- Molded plastic base with positive suction provide a tight grip in sinks and on countertops



41506



40461



40462 – Designed for cleaning small dessert glasses or shot glasses



Prod No	Description	Trim	Color	Pack	Cs Wt/Cube
<b>Glass Washing Brushes</b>					
40460	8" Twin Glass Washer	2-7/8"	03	6 ea	5.00/1.25
40461	8" Triple Glass Washer	2-7/8"	02, 03	6 ea	10.00/1.87
41506	9-1/2" Pilsner/Hurricane/Standard Style Triple Glass Washer	2-7/8"	00	6 ea	10.15/1.87
40465	Standard Glass Washer Refill Brush (Black Only)	2-7/8"	03	12 ea	3.20/0.45
40462	Shot Glass Cleaning Brush	2-7/8"	03	6 ea	6.50/1.25



## Bottle & Jar Brushes

- A critical tool to make difficult hand washing easier
- Wirewound brushes have smaller diameter plastic handles and softer bristles for delicate cleaning of jars, bottles, and glasses with smaller openings
- FDA compliant block and bristles
- 40415 bottle brush is perfect for cleaning bottles with narrow openings
- 40470 and 41460 are specifically designed to slip easily into bottle necks to remove deposits from hard to reach places

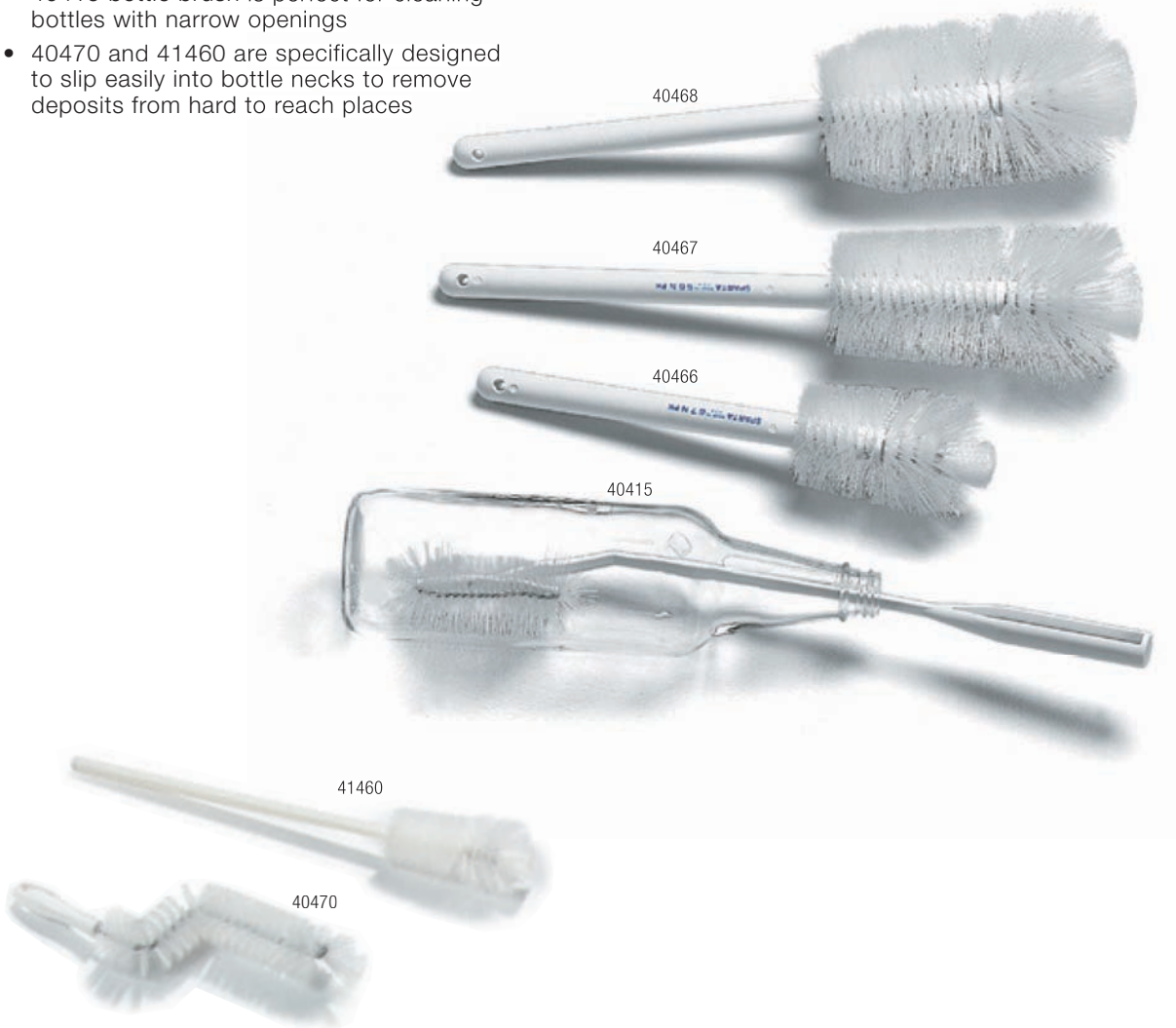

Prod No	Description	Trim	Color	Pack	Cs Wt/Cube
<b>Bottle &amp; Jar Brushes</b>					
40466	12" Handle, Pint Bottle Brush with Polyester Bristles	2-1/2" - 3-1/2"	00	12 ea	4.00/0.65
40467	16" Handle, Quart Bottle Brush with Polyester Bristles	3" - 4-1/4"	02	12 ea	5.00/0.65
41460	24" Handle, Quart Bottle Brush with Polyester Bristles	3"	00	12 ea	7.50/2.06
40468	16" Handle, Half Gallon Brush with Polyester Bristles	4" - 4-1/2"	00	12 ea	5.26/1.28
40469	19" Handle, Gallon Brush with Polyester Bristles	5-1/2"	00	6 ea	4.00/1.10
40415	16-1/2" Handle, Small Bottle Neck Brush with Soft Nylon Bristles	1"	00	12 ea	1.70/0.34
40470	17" Bent Handle, Gallon Brush with Polyester Bristles	2-1/2"	00	6 ea	3.15/0.75

# COMMERCIAL FOODSERVICE OPERATIONS

## Coffee Products Cleaning

- Clean coffee equipment and urns means better tasting coffee and longer equipment life
- 40025 Coffee Decanter Brush designed for thorough cleaning
- 40673 Urn Brush for cleaning glass gauges on coffee urns
- 40154 ideal for cleaning spouts and tubing on percolators, creamers and hot beverage servers
- 40153 Curved Coffee Maker Brush contours to the inside of the coffee pot



## Dishwasher Machine Brush

- Keep spray arms performing at peak efficiency to ensure clean wares



## Vegetable Cutter Brushes

- Expert design makes this difficult cleaning job easier
- Extra stiff nylon bristles reach through the grid of stainless steel vegetable cutters
- FDA compliant block and bristles



Standard(00)

Prod No	Description	Trim	Color	Pack	Cs Wt/Cube
<b>Coffee Products Cleaning</b>					
40025	16" Coffee Decanter Brush with Soft Polyester Bristles	4-19/32" – 6-13/32"	00	6 ea	3.65/1.34
40673	25" Urn Brush with Polyester Bristles	5/8"	00	12 ea	0.94/0.07
40154	12" Creamer Brush with Polyester Bristles	1" & 1-1/2"	00	24 ea	0.66/0.38
40153	10" Curved Coffee Maker Brush with Polyester Bristles	1-1/2"	00	12 ea	3.00/0.44
<b>Dishwasher Machine Brush</b>					
40028	35" Dishwasher Spray Arm with Polyester Bristles	1"	00	12 ea	6.00/0.55
<b>Vegetable Cutter Brush</b>					
40529	2-1/2" Vegetable Cutter with Stiff Nylon Bristles	2"	00	12 ea	6.00/0.30
40532	4-1/4" Onion Cutter with Stiff Nylon Bristles	4-1/4"	00	8 ea	3.82/0.77







### Meat Slicer Cleaning Tool

- Designed for superior employee safety, simplicity and sanitation
- Easy clean-up of slicers without disassembling slicer
- Slicer tool has scraper on one end for scraping hardened foods
- Single use scrub pad wraps around meat slicer tool for thorough cleaning



### Dish Brushes

- Removes stubborn soils to ensure one-pass warewashing
- 3610140 has 180° brush and a scraper to help remove food residue



Prod No	Description	Trim	Color	Pack	Cs Wt/Cube
<b>Meat Slicer Cleaning Tool</b>					
40728	Meat Slicer Cleaning Tool	—	25	12 ea	3.50/0.23
40729	Meat Slicer Scrub Pad, 60 ea/pack, 12 pks/case	—	08	12 pks	3.41/1.14
<b>Dish Brushes</b>					
40413	12" x 2-3/4" Dish Brush	2-3/4"	00	12 ea	4.00/0.65
3610140	8" Dish/Sink Brush	1-1/4"	00	48 ea	7.68/0.46
367600TC	11" Household Dish Brush	2-3/4"	02	6 ea	1.90/0.38

# COMMERCIAL FOODSERVICE OPERATIONS

Not all brushes are alike. **Sparta quality is unsurpassed in the industry** and is committed to providing products with food safety in mind. **Don't settle for less.**

BRUSHES & ACCESSORIES

## Oven & Grill Brushes

### Broiler Master 40026 & 40290

The best grill brush available and master of all grill cleaning tools. Rust-proof bristles are embedded in a rugged specially treated hardwood block for long-lasting cleaning power.

### Double Broiler King 40294

- Sturdy construction with two heads featuring carbon steel flat bristles on one side and carbon steel wire bristles on the other; bolted together on a heavy hardwood handle for very heavy use

### Oven Brush 41520 & 40291

- Crimped brass wire bristles and a full length stainless steel scraper for cleaning high-temperature stack ovens

### Oven Brush 40293

- Crimped brass wire bristles and a full length aluminum scraper on a low-profile head for cleaning the narrow spaces inside pizza ovens

### Pizza/BBQ Oven Brush 45772

- Steel wire bristles and permanent 39" hardwood handle

### Oven & Grill Brush 363725

- Flat wire stainless steel bristles, oven scraper and 30" handle



Standard(00)

Prod No	Description	Color	Pack	Cs Wt/Cube
<b>Oven &amp; Grill Brushes</b>				
40026	8-1/2" Broiler Master Brush, Carbon Steel Bristles with 30" Handle	00	6 ea	15.35/1.62
40290	8-1/2" Broiler Master Brush, Stainless Steel Bristles with 30" Handle	00	6 ea	15.02/1.62
40294	8" Double Broiler King, Carbon Steel Flat & Wire Bristles with 48" Handle	00	2 ea	7.00/1.53
41520	8-1/2" Oven Brush & Scraper, Brass Wire Bristles with 42" Handle	00	1 ea	2.60/0.55
40291	8-1/2" Oven Brush & Scraper, Brass Wire Bristles (Head Only)	00	12 ea	13.00/0.44
40293	10" Oven Brush & Scraper, Brass Wire Bristles (Head Only)	00	12 ea	10.70/0.22
45772	5-1/2" Pizza/BBQ Oven Brush, Carbon Steel Bristles and 33" Handle	00	12 ea	19.00/1.21
363725	8" Oven Brush with Scraper, Flat Wire Stainless Steel Bristles with 30" Handle	00	1 ea	3.00/0.64

NOTE: Equipment must be turned off prior to using Oven & Grill Brushes



40710

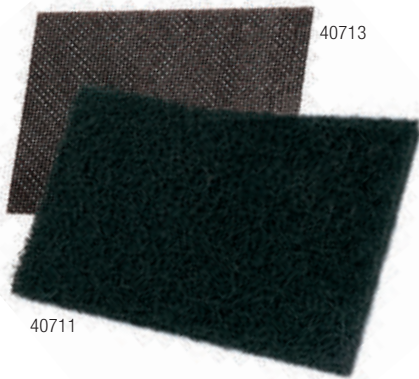

40711

40713

## Grill Bricks, Screens & Polishing Pads

- Apply with cooking oil to protect the grill, cure and remove excess cooked-on foods
- 40710 Grill Brick is a fast, efficient, and sanitary way to clean hot or cold grills
- Plastic wrapping on Grill Brick dissolves to eliminate mess
- 40713 Grill Screen and 40711 Grill Polishing Pad attach to the 40712 Grill Pad Holder for a complete grill maintenance system



40712

## Scratch Brushes

- Compact profile for heavy scraping and cleaning in tight, narrow spaces; provides quick, aggressive removal of grease and deposits
- Available with wood handles for cleaning hot grills and ovens
- Available in nylon, stainless steel or carbon steel wire bristles for normal to tougher cleaning jobs



45779

40671

40670

40672

40027

45571

Standard(00)

Prod No	Description	Handle	Color	Pack	Cs Wt/Cube
<b>Grill Bricks, Screens &amp; Polishing Pads</b>					
40710	3-1/2" x 4" x 8" Grill Brick	—	00	12 ea	8.00/0.92
40711	4" x 5" x 1/4" Grill Polishing Pads, 10 ea/pack, 6 pks/case	—	00	6 pks	4.60/0.70
40712	Grill Pad Holder	Plastic	00	10 ea	6.00/0.32
40713	4" x 5-1/2" Grill Screen, 20 ea/pack, 10 pks/case	—	00	10 pks	3.75/0.13
<b>Scratch Brushes</b>					
45779	11" Brush & Scraper with Carbon Steel Bristles	Wood	00	12 ea	7.00/0.34
40671	11-1/2" Scratch Brush & Scraper with Carbon Steel Bristles	Plastic	00	12 ea	4.50/0.22
40670	11-1/2" Scratch Brush with Carbon Steel Bristles	Plastic	00	12 ea	4.06/0.22
40672	11-1/2" Scratch Brush & Scraper with Stainless Steel Bristles	Plastic	00	12 ea	4.60/0.22
40027	11-1/2" Scratch Brush with Nylon Bristles	Plastic	00	12 ea	3.10/0.22
45571	20" Brush & Scraper with Carbon Steel Bristles	Wood	00	12 ea	10.00/4.14

NOTE: Equipment must be turned off prior to using Scratch Brushes

# COMMERCIAL FOODSERVICE OPERATIONS

**Sparta** Pastry & Basting Brushes have been the **top choice** of discriminating professional chefs the world over for decades. The **high quality craftsmanship** provides the **best bristle retention in the industry**. You should never sacrifice food safety and with our wide selection of brushes, we have a brush to cover **all of your needs**.



### Other Brands

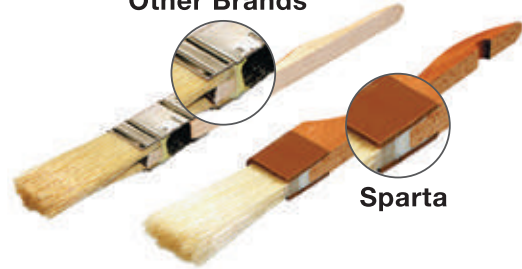

**Sparta**

### Superior Food Safety Construction

Epoxy-set ferrules on all Sparta Pastry/Basting Brushes are especially designed for foodservice use; eliminating hazardous bacteria traps commonly found in other brushes. Sparta Pastry/Basting Brushes are available in a wide range of sizes and styles.

## Chef Series™ Brushes

- Professional, high-quality lacquered hardwood handles with brown plastic ferrules are the choice of top chefs
- Bristles are epoxy-set to ferrules to provide superior bristle retention and to prevent bacteria harboring air pockets

### Sparta Chef Series Croissant Brush

- Extra long bleached boar bristles for use on the most delicate of pastries and foods



## Chef Series Basting Brushes

- The professional's choice for use in basting meats and poultry
- Durable sterilized, double-boiled, bleached boar bristles
- Withstands temperatures of up to 500°F

Note: Basting brushes should not be cleaned in dishwashers. Brushes should be dipped in a commercial cleaning solution and rinsed.



For usage information on these and other brushes included in our 21 Key Brushes Set, check out our 21 Key Brush Guide on page 21

Standard(00)

Prod No	Description	Color	Pack	Cs Wt/Cube
<b>Sparta Chef Series Croissant Brush</b>				
40377	1-1/2" Wide Brush with Boar Bristles	00	12 ea	3.00/0.13
<b>Sparta Chef Series Basting Brushes</b>				
40370	12" Handle with 2" Wide Brush with Boar Bristles	00	12 ea	2.95/0.23
40371	12" Handle with 4" Wide Brush with Boar Bristles	00	12 ea	6.00/0.65
40372	1" Wide Flat Brush with Boar Bristles	00	12 ea	1.00/0.05
40373	1-1/2" Wide Flat Brush with Boar Bristles	00	12 ea	1.36/0.05
40374	2" Wide Flat Brush with Boar Bristles	00	12 ea	1.75/0.08
40375	3" Wide Flat Brush with Boar Bristles	00	12 ea	3.10/0.17
40376	4" Wide Flat Brush with Boar Bristles	00	12 ea	4.65/0.23
40380	1" Round Brush with Boar Bristles	00	12 ea	2.26/0.13





### Chef Series Pastry Brushes

- The finest commercial brushes of their kind
- Offers the performance, delicate touch, and long-lasting value by which all others are judged
- Soft, flagged, white nylon bristles have high fluid retaining capacity and provide a soft touch to delicate pastries



### Meteor Pastry/Basting Brushes

- “Molded-into-the-handle” hook hangs on lip of crocks and containers to prevent bristle burn, melt, or distortion
- Soft flagged bristles are molded into handle to prevent bacteria harboring air pockets
- Available with white nylon bristles or double-boiled, bleached, sterilized, premium boar bristles

Hook hangs on side of crock or elevates bristles off counter tops



### Bristles Heat Distortion Point

<b>Synthetic</b>	Up to 350°F (176.7°C)
<b>Boar</b>	500°F (260°C)
<b>Silicone</b>	500°F (260°C)



Prod No	Description	Color	Pack	Cs Wt/Cube
<b>Sparta Chef Series Pastry Brushes</b>				
40395	1" Wide Brush with Nylon Bristles	—	12 ea	1.06/0.05
40396	1-1/2" Wide Brush with Nylon Bristles	—	12 ea	1.36/0.05
40397	2" Wide Brush with Nylon Bristles	—	12 ea	1.70/0.08
40398	3" Wide Brush with Nylon Bristles	—	12 ea	2.90/0.17
40399	4" Wide Brush with Nylon Bristles	—	12 ea	4.36/0.23
40400	1" Round Brush with Nylon Bristles	—	12 ea	2.15/0.13
<b>Sparta Meteor Pastry/Basting Brushes</b>				
40378	2" Wide Brush with Boar Bristles	—	12 ea	1.96/0.13
40379	3" Wide Brush with Boar Bristles	—	12 ea	2.50/0.17
40401	2" Wide Brush with Nylon Bristles	02, 14	12 ea	2.00/0.13
40402	3" Wide Brush with Nylon Bristles	02, 14	12 ea	9.00/0.76

# COMMERCIAL FOODSERVICE OPERATIONS

## Galaxy™ Pastry Brushes

- Bristles are epoxy-set to prevent bacteria harboring air pockets
- One piece plastic handles are easy to clean
- Select brushes also available with blue nylon bristles for added contrast in working with white frostings or other white foods

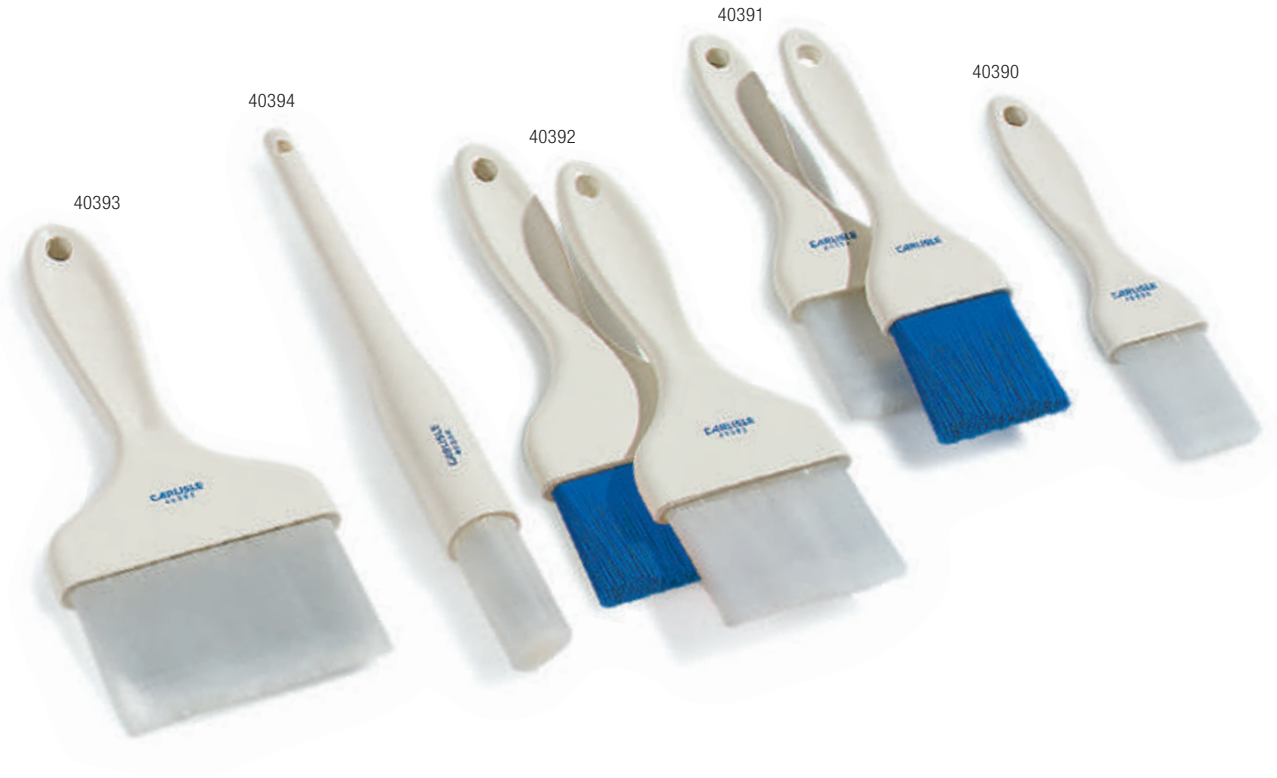

Prod No	Description	Color	Pack	Cs Wt/Cube
<b>Sparta Galaxy Pastry Brushes</b>				
40390	1-1/2" Wide Flat Brush with Nylon Bristles	02	12 ea	1.00/0.05
40391	2" Wide Flat Brush with Nylon Bristles	02, 14	12 ea	1.50/0.13
40392	3" Wide Flat Brush with Nylon Bristles	02, 14	12 ea	1.90/0.13
40393	4" Wide Flat Brush with Nylon Bristles	02, 14	12 ea	2.90/0.16
40394	1" Round Brush with Nylon Bristles	02	12 ea	2.00/0.10



## Silicone Basting Brush

- Dishwasher safe
- Unique bristle design carries and spreads liquid better than ordinary Silicone basting brushes
- Withstands temperatures up to 500°F
- Convenient molded-in hanging hook grabs pan edges to keep brush from sliding in
- Stain and odor resistant

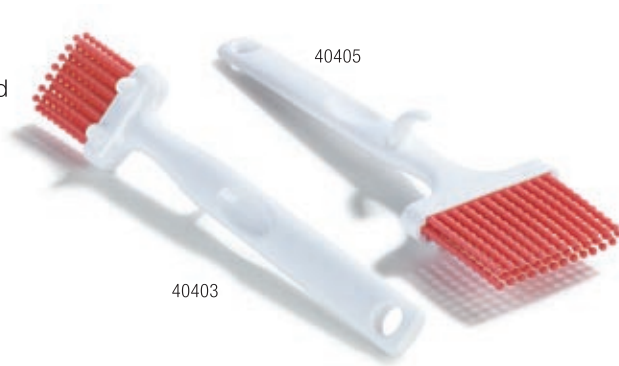

## Food Preparation Brushes

### Potato Brush

- Patented brush has stiff polyester bristles for aggressive cleaning along with a unique “scraper edge” grip for removing hard to reach blemishes on potatoes and other firm vegetables

### Vegetable Brush

- Round loop construction, straight handle with firm bristles



Prod No	Description	Color	Pack	Cs Wt/Cube
<b>Silicone Basting Brushes</b>				
40403	2" Silicone Basting Brush	05	12 ea	2.00/0.13
40405	3" Silicone Basting Brush	05	12 ea	2.00/0.13
<b>Sparta Food Preparation Brushes</b>				
40412	5-3/4" Potato Brush with Medium Stiff Polyester Bristles	02	12 ea	3.00/0.17
40164	9-1/2" Vegetable Brush with Stiff Polyester Bristles	02	12 ea	2.68/0.32

# COMMERCIAL FOODSERVICE OPERATIONS

## High Temp Waffle, Griddle & Equipment Brushes

- Expert design and construction increases food quality and labor productivity
- Made of stiff bristles that withstand temperatures up to 500°F
- Saves time since equipment can be cleaned while hot
- Plastic handles stay cool to the touch
- 40114 has extra stiff bristles for cleaning waffle irons, griddles, and grills while still hot
- 40115 is a pastry style brush designed for buttering and basting hot surfaces
- 40113 Utility Brush for cleaning hot vats, utensils and other equipment



## Sanitary Mallet

- Polypropylene construction washes clean, dries quickly
- Ideal for the toughest kitchen and plant jobs

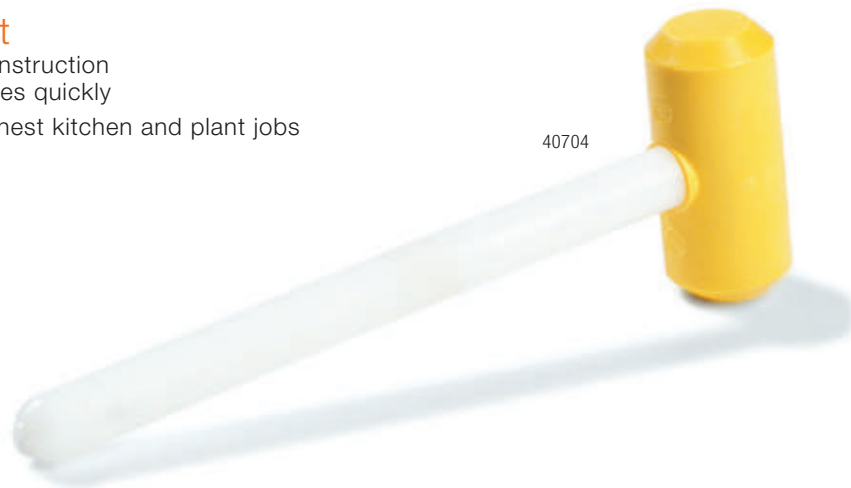

Standard(00)

Prod No	Description	Trim	Color	Pack	Cs Wt/Cube
<b>High Temp Waffle, Griddle &amp; Equipment Brushes</b>					
40114	3" Wide Brush with Bristles	15/16" - 1"	00	12 ea	2.35/0.16
40115	1" Round Brush with Bristles	2"	00	12 ea	1.85/0.10
40113	20" Utility Brush with Bristles	2"	00	12 ea	11.90/1.06
<b>Sanitary Mallet</b>					
40704	14" Polypropylene Mallet	—	00	12 ea	7.75/0.65
41446	Replacement Handle for 40704	—	00	12 ea	4.75/0.23







### Square Steri- & Suds-Pail®

- 3, 6 and 8 quart pails meet board of health & HACCP guidelines for dedicated containers
- Use Red Steri-Pails for sanitizing solutions, Green Suds-Pails for cleaning solutions
- Pails have both standard and metric measurements on the interior walls
- Helper handles for better control
- Instructions for mixing and using sanitizing solutions is printed on the pails in English and Spanish
- Made of sturdy, dishwasher-safe plastic



### Micro fiber Cleaning/Polishing Cloths

- 36333 is great for mirrors, windows and metallic surfaces
- 36334 is perfect for general cleaning



Prod No	Description	Color	Pack	Cs Wt/Cube
<b>Square Steri- &amp; Suds-Pail</b>				
11828	3 qt Square Steri-Pail	05	12 ea	4.47/1.31
11829	6 qt Square Steri-Pail	05	12 ea	7.25/2.24
11830	8 qt Square Steri-Pail	05	12 ea	12.63/3.03
11831	3 qt Square Suds-Pail	09	12 ea	4.47/1.31
11832	6 qt Square Suds-Pail	09	12 ea	7.25/2.24
11833	8 qt Square Suds-Pail	09	12 ea	12.63/3.03
<b>Microfiber Cleaning/Polishing Cloths</b>				
36333	16" x 16" Microfiber Suede Polishing Cloth	14	12 ea	1.20/0.16
36334	16" x 16" Microfiber Terry Polishing Cloth	02, 04, 05, 09, 14	12 ea	1.20/0.17



# VEHICLE BRUSHES

Sparta offers a wide range of professional vehicle brushes, each one **designed for effective cleaning of hard but delicate surfaces.**

## Acid Wash

- Designed for use with diluted acid on cement trucks or wherever phosphoric acid dilution cleaners are used
- 361228 has one threaded handle hole; 361230 has one tapered and one threaded handle hole



## Dip-Style

- For larger vehicles, trucks and trailers
- Plastic foam block resists water



## Hand-Held

- Designed for auto laundries to effectively clean hard but delicate finishes
- Soft, dense fill removes dirt and soil from car finishes, windows, and mobile homes



Handles sold separately; see pages 176-180 for handle recommendations



Prod No	Description	Trim	Bristle	Handle	Color	Pack	Cs Wt/Cube
<b>Acid Wash Brushes</b>							
361228	8" Vehicle Wash Brush with Crimped Polypropylene Bristles	2-1/2"	Soft	Threaded	00	12 ea	11.00/0.84
361230	10" Vehicle Wash Brush with Crimped Polypropylene Bristles	2-1/2"	Soft	Threaded/Tapered	00	12 ea	11.90/1.36
<b>Dip-Style Brushes</b>							
361214	14" Vehicle Wash Brush with Nylex Bristles	2-3/8"	Soft	Threaded	75	12 ea	14.60/1.81
361234	14" Vehicle Wash Brush with Flagged Polystyrene Bristles	2-1/2"	Soft	Threaded	23	12 ea	16.90/1.78
<b>Hand-Held Wash Brushes</b>							
36447	12" Wash Brush with Nylex Bristles	2-3/8"	Soft	—	75	12 ea	12.00/1.56
361040	12" Wash Brush with Boar Bristles	2-5/8"	Soft	—	00	12 ea	12.00/1.56



## Flo-Thru Bumper

- Flo-Thru design delivers a constant flow of water
- Vinyl bumpers protect vehicle finishes



## Flo-Thru Acid Wash

- Designed for use with diluted acid on cement trucks or wherever phosphoric acid dilution cleaners are used
- Flo-Thru design delivers a constant flow of water

Handles sold separately; see pages 176-180 for handle recommendations



Prod No	Description	Trim	Bristle	Color	Pack	Cs Wt/Cube
<b>Flo-Thru Bumper Brushes</b>						
40050	9-1/2" Flo-Thru Brush with Flagged Nylex Bristles	2-1/2"	Soft	02, 04, 05, 14, 75	12 ea	15.50/1.19
41278	10" Flo-Thru Flared Brush with Flagged Nylex Bristles	2-1/8"	Soft	02, 04, 05, 14, 75	12 ea	15.50/2.11
36468	10" Flo-Thru Brush with Flagged Nylex Bristles	2-3/8"	Soft	14, 75	12 ea	13.00/1.39
36467	10" Flo-Thru Brush with Tampico Mix Bristles	2-1/2"	Medium	00	12 ea	16.00/1.26
36466	10" Flo-Thru Brush with Flagged Polystyrene Bristles	2-3/8"	Soft	00	12 ea	14.45/1.36
<b>Flo-Thru Acid Wash Brushes</b>						
361209	9" Vehicle Wash Brush with Polystyrene Bristles	2-3/4"	Soft	02	12 ea	15.18/1.32
361252	10" Vehicle Wash Brush with Polystyrene Bristles	2-5/8"	Soft	02	12 ea	17.25/1.26



# VEHICLE BRUSHES

## Flo-Thru Dual-Surface®

- Dual Surface design keeps the bristles working at almost every angle for more efficient cleaning
- 36497, 361297 feature fountain-style holes for even distribution of water



3621997



361297



36497

## Flo-Thru Fountain-Style

- Professional grade vehicle wash brush with vinyl bumper to protect vehicle finishes
- Finely threaded brass insert allows for quick handle attachment
- National Pipe Thread (NPT) Taper
- Designed for coin operated units and car dealerships



36372

Handles sold separately; see pages 176-180 for handle recommendations



Prod No	Description	Trim	Bristle	Color	Pack	Cs Wt/Cube
<b>Flo-Thru Fountain-Style Brushes</b>						
36372	10" Flo-Thru Brush with Boar Bristles	3-3/4"	Soft	00	12 ea	15.96/1.54
<b>Flo-Thru Dual Surface Brushes</b>						
36497	10" Flo-Thru Dual Surface Brush with Flagged Polystyrene Bristles	2-1/2"	Soft	00	12 ea	18.00/1.74
3621997	10" Flo-Thru Dual Surface Brush with Polystyrene Bristles	2-1/2"	Soft	00	12 ea	18.00/1.74
361297	10" Flo-Thru Dual Surface Wash Brush with Nylex Bristles	2-7/8"	Soft	75	12 ea	14.50/1.74



### Hand-Held Utility

- Soft polystyrene bristles for light scrubbing



361250

### Parts Cleaning Brush

- Designed to hold and work solutions into intricate areas while removing oil, dirt and paint



36573

### Flo-Thru Window Brushes

- To be used with a handle extension for cleaning hard to reach spots on trucks, buses or other large items requiring brush cleaning; including convenience stores and truck stops
- Flo-Thru feature is compatible with water fed handles
- Flagged polypropylene bristles are great for intricately designed windows



3651



45350



361222



Prod No	Description	Trim	Bristle	Color	Pack	Cs Wt/Cube
<b>Hand-Held Utility Wash Brush</b>						
361250	20" Utility Vehicle Wash Brush with Soft Polystyrene Bristles	2-5/8"	Soft	02	12 ea	9.18/1.35
<b>Parts Cleaning Brush</b>						
36573	10" Round Cut Cleaning Brush with Polypropylene Bristles	2-3/4"	Soft	03	12 ea	1.56/0.79

Prod No	Description	Trim	Handle	Color	Pack	Cs Wt/Cube
<b>Flo-Thru Window Brushes with Plastic Block</b>						
45350	4-1/2" Roundx Window Brush with Flagged Polypropylene Bristles	2-5/8"	Flo-Thru/Threaded/Tapered	23	12 ea	10.75/1.28
3651	4-1/2" Round Window Brush with Horsehair/PPE Blend Bristles	2-1/2"	Flo-Thru/Threaded/Tapered	27	12 ea	12.00/1.05
361221	8" Flo-Thru Window Brush with Flagged Polystyrene Bristles	2-1/2"	Flo-Thru/Threaded	24	12 ea	10.60/0.97
361222	10" Flo-Thru Window Brush with Flagged Polystyrene Bristles	2-1/2"	Flo-Thru/Threaded/Tapered	24	12 ea	14.18/1.26

# WINDOW CLEANING

## Sponge

- Multi-purpose large sponge
- Natural color, synthetic material



## Window Scrapers

- For scraping stubborn debris from window and floor surfaces
- Attach to handle to use as a floor scraper
- Professional 4" wide scrapers
- 4" scraper has one sharp edge and one dull edge



Standard(00)

Prod No	Description	Handle Style	Color	Pack	Cs Wt/Cube
<b>Sponge</b>					
365501	2-1/4" x 4-1/4" x 8-1/4" Extra Large Size	—	00	24 ea	1.44/2.15
<b>Complete Window Scrapers</b>					
365117	Scraper with 6" Plastic Handle Head & Blade	Tapered/ Threaded	00	10 ea	3.10/0.26
365119	Scraper with 48" Metal Handle Head & Blade	Tapered/ Threaded	00	10 ea	15.00/1.02
365120	4" Replacement Blade Dispenser 10 ea/pk, 10 pks/case	—	00	10 pks	2.00/0.89





### Strip Window Washers & Bucket

- Window washer has light-weight and durable handle
- Synthetic fiber mitt for better water retention, residue removal and longer life
- Rectangular bucket has 6 gallon capacity
- Includes snap-on lid and clip-on plastic sleeve for window washers and squeegees
- Molded-in graduations
- Ergonomic handle for easy transportation



40069



3633019



Prod No	Description	Handle Style	Color	Pack	Cs Wt/Cube
<b>Strip Window Washer &amp; Bucket</b>					
40069	14" Complete Strip Washer Head	Tapered/Threaded	00	10 ea	3.20/0.50
40095	14" Strip Washer Mitt	—	00	10 ea	1.20/0.23
3633019	18" Rectangular Microfiber Bucket	—	23	3 ea	12.50/1.15



# WINDOW CLEANING

## Squeegees with Rubber Blades and Zinc Plated Handle

- Double blade, red thermal rubber blades and zinc plated steel frame yields superior performance at an affordable price
- Single blade, black, special blend rubber for a streak free professional finish. Zinc plated steel frame with a long handle socket that is easy to hold and fits a tapered handle

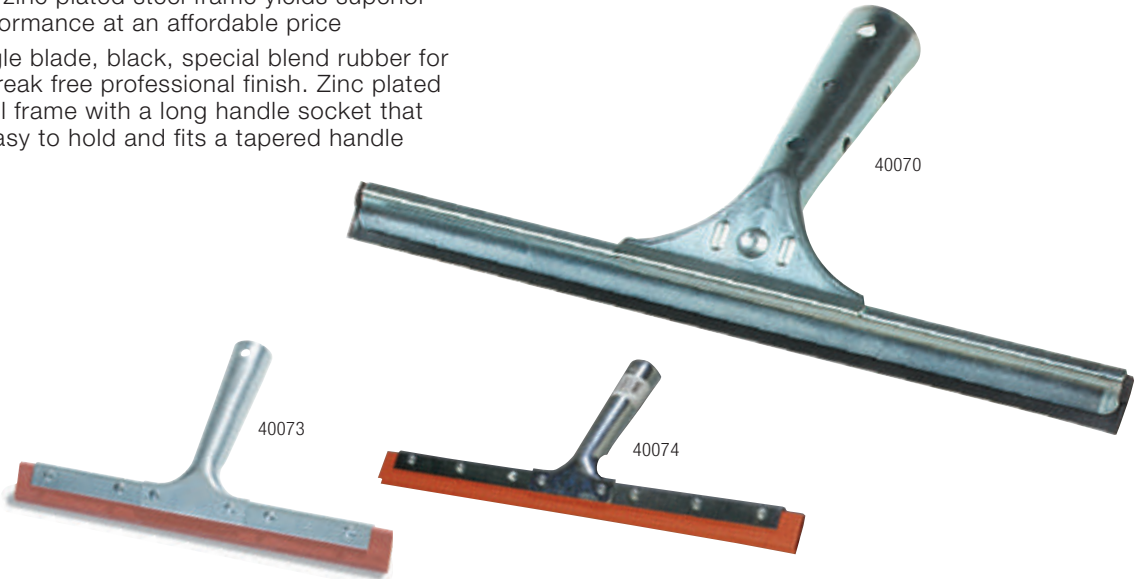

## Rubber Blades with Stainless Steel Channel

- Purchase separately or as replacement parts

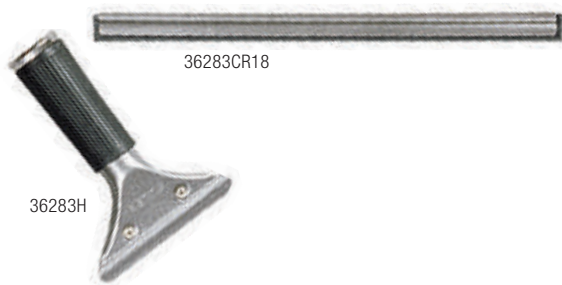

Handles sold separately; see pages 176-180 for handle recommendations

Standard(00)

Prod No	Description	Handle Style	Color	Pack	Cs Wt/Cube
<b>Double Blade Rubber Squeegee with Zinc Plated Steel Handle</b>					
40072	8" Professional Double Blade Rubber Squeegee	Tapered	00	12 ea	7.00/1.00
40073	10" Professional Double Blade Rubber Squeegee	Tapered	00	12 ea	9.00/1.06
41027	12" Professional Double Blade Rubber Squeegee	Tapered	00	6 ea	9.40/0.20
40074	14" Professional Double Blade Rubber Squeegee	Tapered	00	12 ea	9.55/1.30
<b>Single Blade Rubber Squeegee with Zinc Plated Steel Handle</b>					
40070	12" Professional Single Blade Rubber Squeegee	Tapered	00	12 ea	9.50/1.07
40071	16" Professional Single Blade Rubber Squeegee	Tapered	00	12 ea	11.00/1.40
<b>Single Blade Rubber Squeegee with Stainless Steel Channel</b>					
36283CR18	18" Stainless Steel Channel with Rubber Squeegee	—	00	10 ea	4.80/0.19
36283H	Stainless Steel Handle for 36283CR Squeegee	365408	00	10 ea	10.00/1.37





### Windshield Washer/Squeegee

- For convenience store and retail applications including in-house and over-the-counter; most commonly used to clean windows and car windshields
- Flexible rubber squeegee removes cleaning solution
- Comes complete with threaded handle



### Multi-Purpose Clamp

- Used to clamp a sponge or towel to a handle for cleaning high-traffic areas
- For use with 365408 telescopic handle



### Single Rubber Blade with Aluminum Channel

- Economy squeegee for simple, light use; purchase separately and as replacement parts
- Light-weight and durable
- Plastic handle clamps tightly onto squeegee channel



Standard(00)

Prod No	Description	Handle Style	Color	Pack	Cs Wt/Cube
<b>Windshield Washer/Squeegee</b>					
362868	14-7/8" Handle with 8" Mesh Covered Sponge	—	00	12 ea	5.04/1.36
<b>Single Rubber Blade with Aluminum Channel</b>					
36281CR16	16" Aluminum Channel Squeegee Blade (Only)	36281H	00	30 ea	5.00/0.19
36281H	Plastic Handle Head for 36281CR Squeegees	Tapered/Threaded	00	30 ea	3.75/0.56
<b>Multi-Purpose Clamp</b>					
365108	Multi-Purpose Clamp	365408	00	10 ea	6.30/0.50

# RESTROOM MAINTENANCE

## Polyester Brushes

- 45532 wire-wound head prevents scratching; long reach handle
- 40140 has 180° bristle head to prevent splash back



## Bowl Mops

- Non-scratching
- 36238 has nylon fiber head to provide consistent bowl cleaning
- 36232 and 36233 have all-natural cotton yarn securely attached to smooth wood handle



### 36238C

- Nylon fiber head provides consistent bowl cleaning
- Sliding cone cap removes excess liquids



## Polypropylene Brushes

- Non-scratching bristles are not affected by standard bowl cleaners
- 36313 and 361006 have vinyl-coated wire to provide additional scratch protection

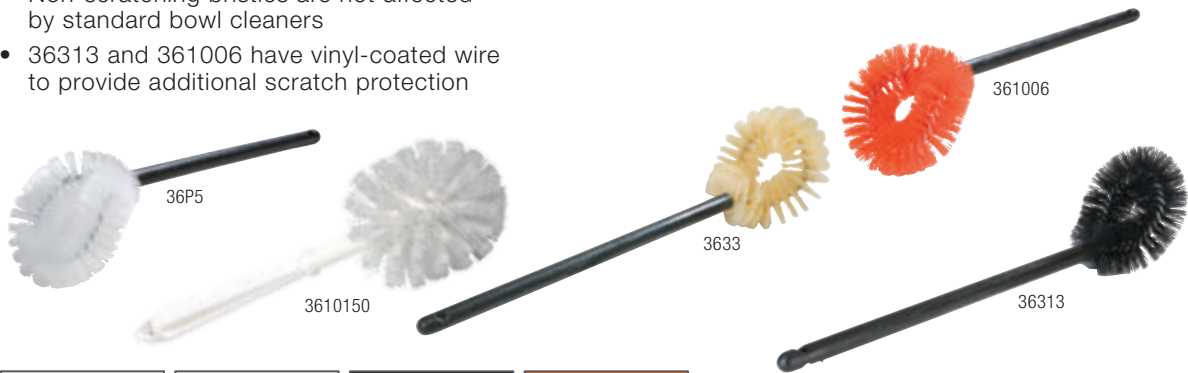

Prod No	Description	Trim	Bristle	Color	Pack	Cs Wt/Cube
<b>Polypropylene Brushes</b>						
3610150	11" Bowl Brush with Polypropylene Bristles	1-5/8"	Medium	02	24 ea	5.28/1.27
3610136	12" Bowl Brush with Polypropylene Bristles	2" Dia	Medium	00	48 ea	17.28/2.17
36P5	17" Bowl Brush with Polypropylene Bristles	2-1/8"	Medium	02	24 ea	7.50/2.08
361006	21" Bowl Brush with Polypropylene Bristles	2-1/8"	Medium	24	24 ea	9.25/2.08
3633	21" Bowl Brush with Polypropylene Bristles	2"	Medium	00	24 ea	8.82/2.31
36313	20" Bowl Brush with Nylon Bristles	2-1/4"	Medium	03	24 ea	8.00/2.31
<b>Bowl Mops</b>						
36238	12" Nylon Bowl Mop	6" Dia	—	02	100 ea	13.20/1.96
36238C	13" Nylon Bowl Brush with Cone Cap	—	Medium	02	100 ea	17.60/1.96
36232	10" Cotton Bowl Mop	3-1/2"	—	00	36 ea	3.60/1.15
36233	20" Cotton Bowl Mop	5-1/2"	—	00	36 ea	11.88/1.28
<b>Polyester Brushes</b>						
45532	24" Bowl Brush with Polyester Bristles	3-1/2"	Medium	03	12 ea	5.00/1.21
40140	17" No-Splash Bowl Brush with Polyester Bristles	3-3/4"	Medium	00	12 ea	7.00/1.28





### Bowl Brush with Caddy

- Non-scratching
- Polypropylene bristles are not affected by standard bowl cleaners



### Force Cups

- 36439 features an ergonomic design for maximum applied force and a plastic handle



### The Gripper™

- Get out-of-reach objects and pick up litter easily with just a squeeze of your hand
- Helps keep hands clean



Prod No	Description	Handle	Bristle	Color	Pack	Cs Wt/Cube
<b>Bowl Brush with Caddy</b>						
367197	16" Bowl Brush with Caddy	Plastic	Medium	00*	24 ea	4.80/2.20
<b>Force Cups</b>						
36439	21" Ergonomic Power Plunger	Plastic/Rubber	—	03	12 ea	6.68/0.72
364386	18" Force Cup, 6" Dia	Wood	—	00	12 ea	10.56/0.45
364391	20" Bell-Shaped Force Cup, 6" Dia	Wood	—	00	12 ea	21.00/0.50
<b>The Gripper</b>						
363744	28" Gripper Pick Up Tool	Metal	—	00	12 ea	11.00/1.82



# DUSTERS & ACCESSORIES

## Ceiling, Fan & Wall Dusters

- 363404 requires 365450 handle (sold separately)



## Feather Dusters

- Premium quality; ideal for use in offices, stores and schools



Handles sold separately; see pages 176-180 for handle recommendations



Prod No	Description	Trim	Handle	Bristle	Color	Pack	Cs Wt/Cube
<b>Ceiling, Fan &amp; Wall Dusters</b>							
363401	Wide Wall Duster with PVC Bristles	2-7/8"	Threaded/Telescoping	Soft	00	10 ea	7.50/3.83
36111	Wall & Fan Twist in Wire Brush with PVC Bristles	2-7/8"	Threaded/Telescoping	Soft	14	12 ea	10.00/1.29
363404	Round Duster with Soft Flagged PVC Bristles	2-1/2"	365450	Soft	14	12 ea	4.92/4.48
365450	34" to 59" Extendable Handle	—	—	Soft	00	12 ea	6.96/0.24
<b>Feather Dusters</b>							
45744	21" Feather Duster	—	—	—	00	12 ea	2.40/0.39
45743	24" Ostrich Feather Duster	—	—	—	00	12 ea	3.48/0.40



### Wool Dusters

- Telescopic handles for hard-to-reach areas
- 45733 is made of premium lambs wool and picks up fine dust
- 363156 is electrostatically charged features a bendable handle
- 363156 head can be bent to clean hard-to-reach areas



Standard(00)

Prod No	Description	Handle	Color	Pack	Cs Wt/Cube
<b>Wool Dusters</b>					
363157	26" to 42" Telescoping Poly Wool Duster	Plastic	00	12 ea	4.90/0.33
45733	30" to 42" Telescoping 100% Wool Duster	Plastic	00	12 ea	4.00/0.30
363156	52" to 81" Telescoping Poly Wool Duster	Plastic	00	12 ea	3.96/0.61

# SPARTA® SPECTRUM® SUPERMARKET KITS

- Sparta Spectrum Kits are the easy way to help set up your own HACCP program
- The color-coded kits help employees to segregate brushes by purpose and work zones to help prevent cross-contamination
- Each kit is made up of General Clean-Up Tools and Floor & Drain Care products (see details listed in product chart on following page)

BRUSHES & ACCESSORIES

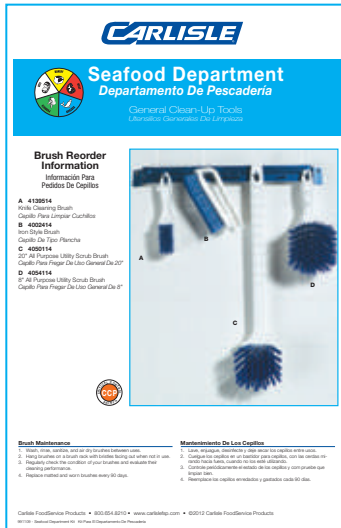

Sparta Spectrum Meat Department Kit 991129

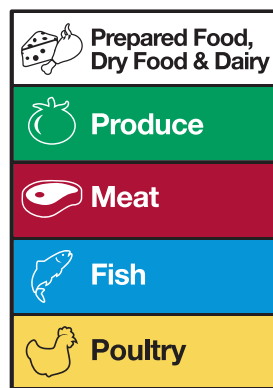

All Sparta Spectrum Kits include two Wall Charts; a General Clean-Up Tools Wall Chart, and a Floor & Drain Care Wall Chart. These laminated, bilingual (English/Spanish) charts provide a visual reference for your employees on proper brush storage, brush maintenance, brush reorder, and information on preventing cross-contamination.

Sparta Spectrum Color-Coded Products are a key group of CCP (Critical Control Point) Products™ designed to promote safe food handling and help prevent hazardous cross-contamination



## Supermarket Kit Product Usage Guide



**40007**  
Meat Grinder/Valve Brush



**40024**  
Iron Style Hand Scrub



**40423 - Hi-Lo Floor Scrub**  
**40225 - Fiberglass Handle**



**40480 - Bench Brush**  
**40379 - Pastry Brush**



**40501**  
20" All Purpose Scrub Brush



**40541**  
8" All Purpose Scrub Brush



**40735**  
Aluminum Brush Rack



**41083**  
Duo-Sweep® Angle Broom



**41395**  
Knife Cleaning Brush



**41891**  
18" Omni Sweep®



**40146**  
Floor Drain Brush  
**40236**  
Drain Brush Handle



**41619**  
Floor Scraper



General Clean-Up and Floor & Drain Care Wall Chart is included in each kit

## Supermarket Kits

		991109 Blue Seafood Kit	991119 Green Produce Kit	991129 Red Meat Kit	991139 Yellow Bakery Kit	991149 White Deli Kit
40007	30" Valve Brush			■		
40024	6" Iron Style Brush	■	■	■	■	■
40225	60" Fiberglass Handle	■	■	■	■	■
40423	10" Hi-Lo Floor Scrub	■	■	■	■	■
40480	8" Bench Brush				■	
40501	20" All Purpose Scrub Brush	■	■	■	■	■
40541	8" All Purpose Scrub Brush	■	■	■	■	■
40735	17" Aluminum Brush Rack (2 per kit)	■	■	■	■	■
41083	Duo-Sweep Unflagged Angle Broom	■	■	■	■	■
41395	Knife Cleaning Brush	■	■	■	■	■
41891	24" Omni Sweep		■			
40146*	3" Drain Brush	■	■	■	■	■
40236*	36" Floor Drain Handle	■	■	■	■	■
40379*	3" Boar Bristle Pastry Brush				■	
41619*	8" Floor Scraper				■	

Note: Each kit contains both a General Clean-Up Wall Chart and a Floor & Drain Care Wall Chart  
To order replacement items use the following color codes: Blue(14), Green(09), Red(05), Yellow(04) and White(02)

\* Items are only available in one color

# PLANT SANITATION

The FDA has identified the need for a well organized and properly implemented sanitation program. It emphasizes the need for a clean plant environment extending from receiving areas to packaging rooms, and from floor to ceiling.

A critical element in this program is the proper selection, use and care of brushes. Brushes should be restricted to their particular zone of use. Brushes should be maintained in good condition, properly stored when not in use and sanitized between uses.

Sparta's Color-Coded Brush Program is the key to keeping brushes in the areas they are used, doing the jobs they are meant to do.

See page 182-183 for more details on our Plant Sanitation Guide

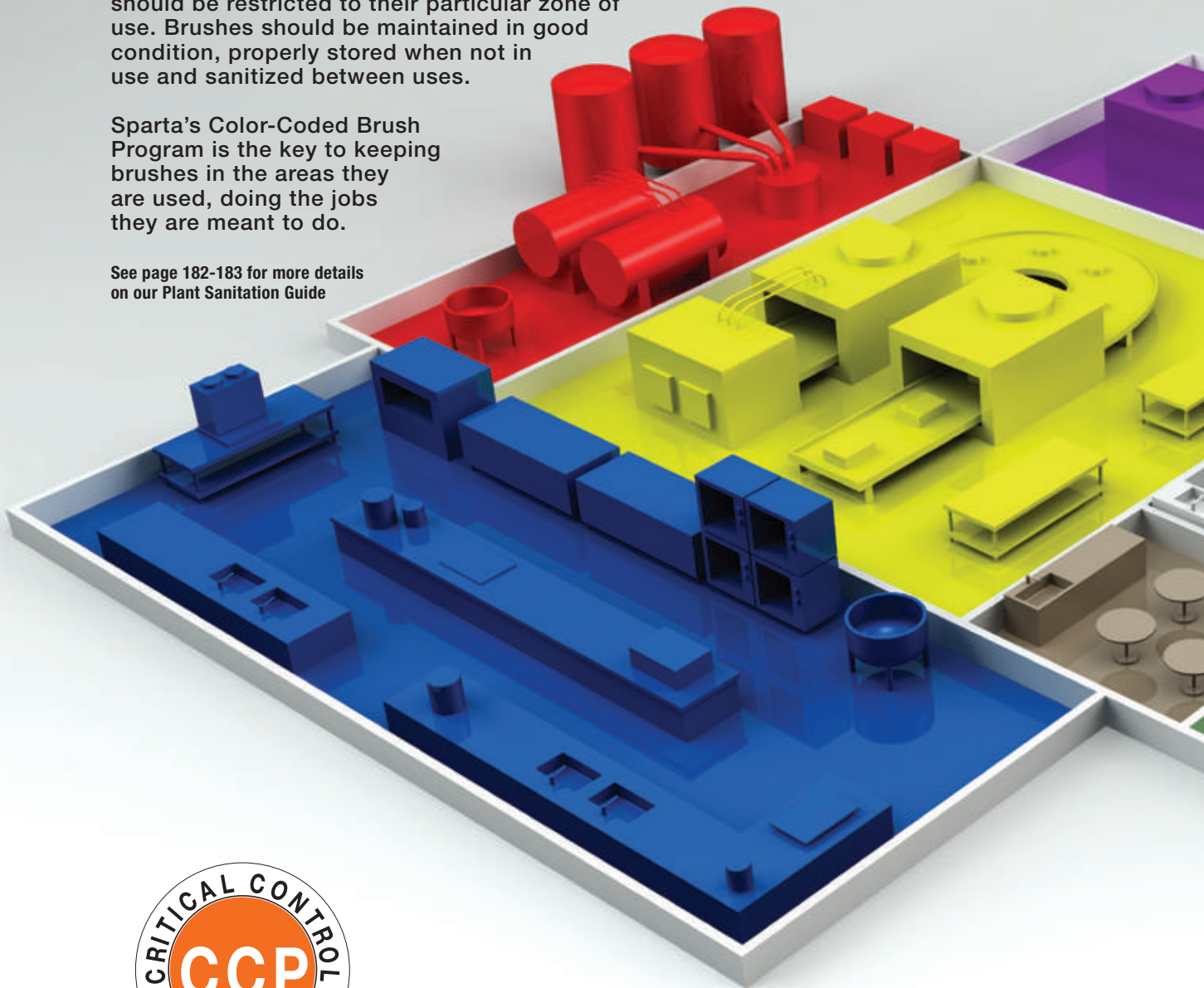



# SPARTA<sup>®</sup> BRUSH

Famous for Quality

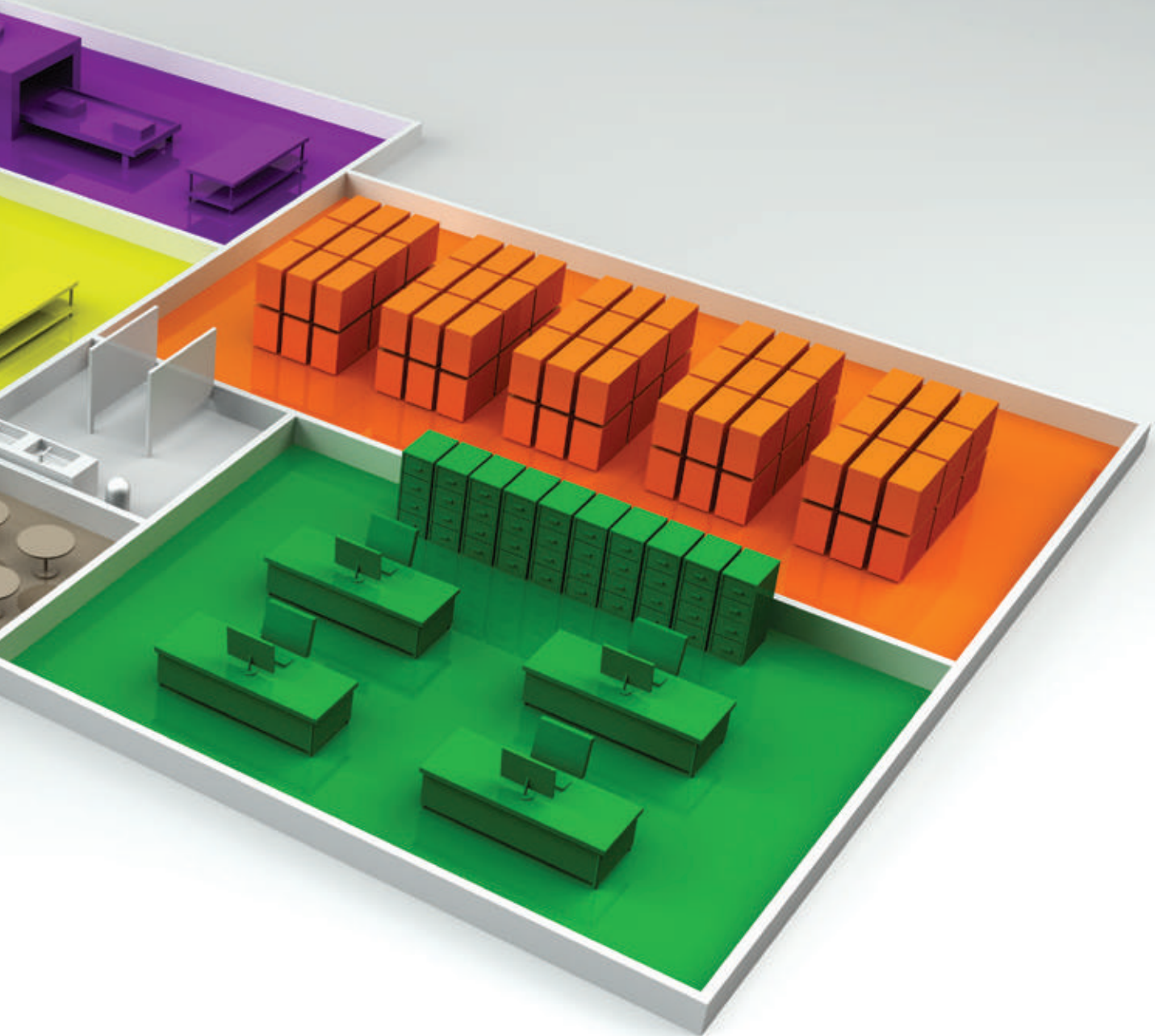



**CARLISLE**

SANITARY MAINTENANCE PRODUCTS

DURABLE  
INNOVATIVE  
VERSATILE  
**FLOOR CARE  
PRODUCTS**

---

*Only Carlisle offers such a broad range of high quality products dedicated to floor care and cleanliness.*

*From sweeps to floor scrubs, angle brooms to dusters, we take pride in your floor care, saving you money on operational costs.*





# BROOMS

Carlisle's brooms are **designed for extended use and offer superior performance.** Whether you're sweeping a lobby, warehouse floor or parking lot, we have **a high-quality solution for you.**



## Duo-Sweep® Angled

- For reaching into corners, along walls and into hard to reach areas
- Block made with tough & durable material that resists cracking, splitting, chipping
- Color coded angle brooms have one handle hole making them more hygienic and HAACP compliant
- Standard color (00) angle brooms have two handle holes; one angled, one upright

## Recycled Angle Broom

- Contains 80% recycled flagged PET bristles and 60% recycled polypropylene copolymer shroud for increased stability
- Includes 48" durable vinyl coated metal handle with swivel hanging cap for storage

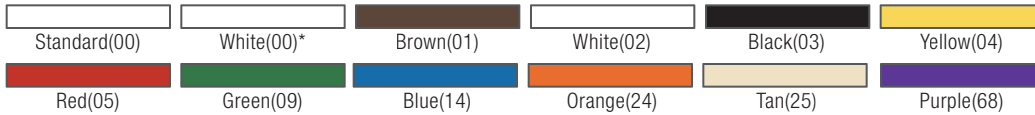

Prod No	Description	Bristle Length	Color	Pack	Cs Wt/Cube
<b>Flagged Duo-Sweep Angle Brooms</b>					
36861	6-1/2" Flagged Duo-Sweep Angle Broom with 30" Metal Handle	5-1/2" - 7"	00	12 ea	9.00/0.31
36865	12" Flagged Duo-Sweep Medium Duty Angle Broom with 48" Metal Handle	5-1/2" - 7"	00	12 ea	9.00/5.08
41082	12" Flagged Duo-Sweep Broom with 48" Fiberglass Handle	5-1/2" - 7"	01, 02, 03, 04, 05, 09, 14, 24, 68	12 ea	28.00/4.89
36867	12" Flagged Duo-Sweep Angle Broom – (Head Only)	5-1/2" - 7"	00, 01, 02, 03, 04, 05, 09, 14, 24, 68	12 ea	12.70/1.56
<b>Unflagged Duo-Sweep Angle Brooms</b>					
36885	12" Unflagged Duo-Sweep Heavy Duty Angle Broom with 48" Metal Handle	5-1/2" - 7"	00	12 ea	21.04/0.31
41083	12" Unflagged Duo-Sweep Broom with 48" Fiberglass Handle	5-1/2" - 7"	01, 02, 03, 04, 05, 09, 14, 24, 68	12 ea	21.34/4.87
36868	12" Unflagged Duo-Sweep 12" Angle Broom (Head Only)	5-1/2" - 7"	01, 02, 03, 04, 05, 09, 14, 24, 25, 68	12 ea	12.44/1.43
<b>Replacement Handles</b>					
41225	48" Fiberglass Handle with Self-Locking Flex™ Tip – 1" D	—	00*, 01, 03, 04, 05, 09, 14, 25	12 ea	10.50/0.64
3620294	48" Plastic Coated Metal Threaded Handle – 15/16" D	—	03	12 ea	8.00/0.46
3620194	48" Powder Coated Metal Threaded Handle – 7/8" D	—	14	12ea	7.85/0.71
<b>Recycled Angle Broom</b>					
40650	12" Flagged Recycled Angle Broom with 48" Steel Handle	6" - 7"	00	12 ea	22.00/5.23



**Flagged**

Great for fine debris and use on smooth surfaces



**Unflagged**

Great for larger debris and rough surfaces: Bristles prevent ends from matting making this style perfect for back-of-house and outdoor applications

**Duo-Sweep® Straight**

- Two handle holes; upright hole for general purpose sweeping or angle hole for reaching into corners, along walls or into hard to reach areas
- Flagged blue synthetic bristle for fine debris
- Stiff black synthetic bristles can be easily cleaned to extend broom life
- Guaranteed to outlast corn brooms 4 to 1



36859



36863



36883



36860



36864



36884

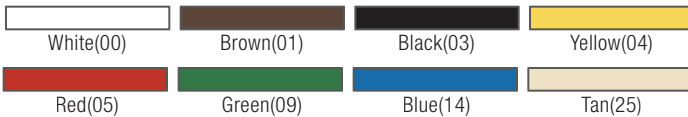

Prod No	Description	Bristle Length	Color	Pack	Cs Wt/Cube
<b>Flagged Duo-Sweep Brooms</b>					
36859	7-1/2" Flagged Duo-Sweep Lobby Broom with 30" Black Metal Handle	4"	14	12 ea	9.00/1.33
36863	11" Flagged Duo-Sweep Light Industrial Broom with 48" Blue Metal Handle	4"	14	12 ea	15.50/4.63
36853	11" Flagged Duo-Sweep Light Industrial Broom (Head Only)	4"	14	12 ea	10.00/1.16
36883	13" Flagged Duo-Sweep Warehouse Broom with 48" Blue Metal Handle	7"	14	12 ea	17.00/3.92
36873	13" Flagged Duo-Sweep Warehouse Broom (Head Only)	7"	14	12 ea	9.00/1.47
<b>Unflagged Duo-Sweep Brooms</b>					
36860	7-1/2" Unflagged Duo-Sweep Lobby Broom with 30" Black Metal Handle	4"	03	12 ea	9.50/1.33
36864	11" Unflagged Duo-Sweep Light Industrial Broom with 48" Blue Metal Handle	4"	03	12 ea	16.00/4.47
36854	11" Unflagged Duo-Sweep Light Industrial Broom (Head Only)	4"	03	12 ea	10.90/1.01
36884	13" Unflagged Duo-Sweep Warehouse Broom with 48" Black Metal Handle	7"	03	12 ea	22.50/4.63
36874	13" Unflagged Duo-Sweep Warehouse Broom (Head Only)	7"	03	12 ea	9.00/1.47
<b>Replacement Handles</b>					
41225	48" Fiberglass Handle with Self-Locking Flex™ Tip – 1" D	—	00, 01, 03, 04, 05, 09, 14, 25	12 ea	10.50/0.64
3620294	48" Plastic Coated Metal Threaded Handle – 15/16" D	—	03	12 ea	8.00/0.46
3620194	48" Powder Coated Metal Threaded Handle – 7/8" D	—	14	12ea	7.85/0.71



# BROOMS

## Natural Corn Blend

- Corn blend brooms have a heavy-duty lacquered wood handle and a high bristle fill count
- 41354 and 36855 heavy-duty warehouse brooms have metal retaining bands and strong synthetic stitching for long-lasting use.
- 41350 janitor broom has wide fan head for greater reach



## 100% Natural Corn

- Heavy-duty lacquered wood handle
- High bristle fill count and 5-sew construction



Prod No	Description	Stitch	Color	Pack	Cs Wt/Cube
<b>Natural Corn Blend Brooms</b>					
36633	10" Corn Whisk	2-Sew	00	12 ea	4.40/0.42
3681	34" Corn Lobby Broom	2-Sew	00	12 ea	6.96/1.33
3682	40" Corn Lobby Broom	3-Sew	00	12 ea	9.00/3.96
41349	55" Housekeeping Broom	3-Sew	67	12 ea	34.00/3.76
41352	55" Housekeeping Broom	4-Sew	00	12 ea	24.00/3.76
41350	56" Janitor Broom	5-Sew	67	12 ea	31.00/3.38
36855	56" Warehouse Broom	4-Sew/1-Wire	00	12 ea	33.00/6.05
41354	56" Heavy Duty Warehouse Broom	4-Sew/1-Wire	67	12 ea	36.75/4.76
<b>100% Natural Corn Broom</b>					
40634	56" Janitor Broom	5-Sew	00	6 ea	15.00/2.57



## Synthetic Corn

- “X” shaped polypropylene bristles allow for superior sweeping on carpeting and entry mats
- Chemical and liquid resistant bristles; sustains temperatures to 225°F
- All, except 36634, have wooden handle
- 41679 has a foam gripped handle
- 45643 and 45649 have metal top for added durability



Prod No	Description	Stitch	Color	Pack	Cs Wt/Cube
<b>Synthetic Corn Brooms</b>					
41679	57" Warehouse/Janitor Broom	6-Sew	03	12 ea	23.75/3.85
41680	55" Housekeeping Broom	5-Sew	03	12 ea	25.75/4.76
45649	54" Housekeeping Broom with Metal Top	Wire/Metal Top	01	6 ea	17.30/1.61
45643	48" Maid Broom with Metal Top	Wire/Metal Top	04	12 ea	18.86/3.44
41683	40" Toy/Lobby Broom	3-Sew	03	12 ea	10.25/1.21
36634	9" Plastic Corn Whisk	2-Sew	00	12 ea	3.96/1.34



# DUSTPANS

## Lobby Pan & Broom Combos

- Lobby pans and brooms with sectional handles to give you over 50% reduction in carton size; lower cube saves warehouse space and shipping costs
- The lobby pans pivot and lock into place during use and release for easy carrying or emptying
- Handles feature a pivoting hanging hole at top for storage

### 361415 Combo includes the following:

- Serrated edge allows you to comb the broom's bristles and drop debris into the pan
- Handy clip to attach broom for convenient storage
- 30" two-piece handle made from vinyl coated steel

### 361416 Combo includes the following:

- Adjustable position head for more functional use in corners and under counters or tables
- Handy clip to attach broom for convenient storage
- Shelf-friendly packaging



Black(03)

Prod No	Description	Material	Style	Color	Pack	Cs Wt/Cube
<b>Lobby Pan &amp; Broom Combos</b>						
361415	Duo-Pan™ Lobby Pan & Duo-Sweep Broom Combo	Plastic	Lobby	03	1 ea	3.75/0.46
361412	Broom Handle Clip for 361415	—	—	03	12 ea	5.04/0.16
361416	Duo-Pan™ II Lobby Pan & Broom Combo	Plastic	Lobby	03	4 ea	12.00/1.56





## Dust & Lobby Pans

- Dust Pans are available in metal or plastic as well as in a “flip-up” lobby style or hand held
- Dust pan (361437) features a 90° threaded handle hole to convert it to an economy lobby dustpan
- 361420 features a 2 piece handle which reduces the carton size saving warehouse space and shipping costs



361437



36236



361420

## Floor Sweepers

- Brushless mechanical sweeper has non-marking rubber blades that grab fine particles and heavy debris from various types of floor surfaces
- Large capacity dust bins thoroughly clean blades as they rotate; won't re-deposit dirt like ordinary sweepers
- Easy one touch doors for emptying debris
- Shelf-friendly packaging



36399



Prod No	Description	Material	Style	Color	Pack	Cs Wt/Cube
<b>Dust &amp; Lobby Pans</b>						
36142003	Lobby Dust Pan with 2-Piece Handle	—	Lobby	03	1 ea	2.53/0.47
361437	12" Wide Rubberized Plastic Dustpan	Plastic	Hand-Held	03	24 ea	12.96/3.13
36236	12" Metal Dustpan	Heavy Gauge Steel	Hand-Held	03	12 ea	14.04/2.08
361410	12" Duo-Pan™ Plastic Lobby Pan with Metal Handle	Plastic	Lobby	03	6 ea	14.50/2.05
36141003-1	12" Duo-Pan™ Plastic Lobby Pan with Metal Handle	Plastic	Lobby	—	1 ea	3.02/1.16
<b>Floor Sweepers</b>						
36399	9-1/2" Multi-Surface Sweeper	—	—	14	4 ea	10.30/0.91
36400	12" Multi-Surface Sweeper	—	—	14	4 ea	12.0/1.56

# FLOOR SWEEPING

Omni Sweep's patented unique design combines the features of fine, medium, and heavy floor sweeps in a **convenient all-in-one design**. For light to heavy dirt, Omni Sweep is the best choice for any surface application.



## Omni Sweep®

- Effective on all types of floor surfaces
- Short, heavy bristles in front easily sweeps up heavy debris
- Long, fine/medium bristles in back sweep fine dust and particles
- Anchor Style hardwood block requires 60" Anchor Hardwood Handle (45270), sold separately



**Anchor Clamp**  
Holds hardwood Anchor Block



**Angled Pitch**  
Fast, effective sweeping



Handles sold separately; see pages 176-180 for handle recommendations

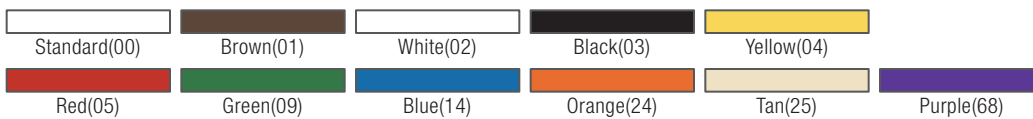

Prod No	Description	Bristle Length	Handle	Color	Pack	Cs Wt/Cube
<b>Omni Sweep – Plastic Block</b>						
41880	18" Omni Sweep	1-5/8" - 2-3/8"	Threaded	00	12 ea	21.00/2.14
41890	18" Omni Sweep	1-5/8" - 2-3/8"	Threaded	02, 04, 05, 09, 14, 24, 68	12 ea	21.00/2.14
41881	24" Omni Sweep	1-5/8" - 2-3/8"	Threaded	00	12 ea	27.75/2.61
41891	24" Omni Sweep	1-5/8" - 2-3/8"	Threaded	02, 04, 05, 09, 14, 24, 68	12 ea	27.75/2.61
<b>Anchor Style Omni Sweep – Hardwood Block and Clamp</b>						
41870	18" Anchor Style Omni Sweep*	1-5/8" - 2-3/8"	Anchor	00	12 ea	30.00/2.82
41871	24" Anchor Style Omni Sweep*	1-5/8" - 2-3/8"	Anchor	00	12 ea	40.00/3.69
41872	36" Anchor Style Omni Sweep*	1-5/8" - 2-3/8"	Anchor	00	6 ea	30.00/3.48
<b>Omni Sweep Replacements &amp; Accessories</b>						
40225	60" Sparta Spectrum Fiberglass Handle with Self-Locking Flex-Tip – 1" D	—	—	01, 02, 03, 04, 05, 09, 14, 24, 25, 68	12 ea	13.00/0.80
45196	Anchor Clamp with 2 ea bolt & wing nuts	—	—	00	12 ea	6.48/0.16
45270	60" Anchor Wood Handle – 1-1/8" D	—	—	00	12 ea	22.50/0.84

\*Anchor clamp included





### Sweep Complete™

- Sweep Complete includes a 60" handle and brace
- Dual handle holes extends the life of a sweep
- Integrated squeegee is ideal for wet applications



36219618

Blue(14)

Prod No	Description	Bristle Length	Handle	Color	Pack	Cs Wt/Cube
<b>Sweep Complete Floor Sweeps</b>						
36219618	18" Sweep Complete Floor Sweep with Squeegee	3"	Threaded	14	6 ea	17.47/1.95
36219624	24" Sweep Complete Floor Sweep with Squeegee	3"	Threaded	14	6 ea	21.12/2.37



# FLOOR SWEEPING

## Fine/Medium Ready Sweeps

- Come assembled with a 60" handle and 1-1/8" brace
- Wet or dry sweeping of smooth surfaces

367382TC



367396TC



367366TC



Prod No	Description	Trim	Handle	Color	Pack	Cs Wt/Cube
<b>Fine Ready Sweeps - Hardwood Block</b>						
367382TC	24" Fine Sweep w/Flagged Blue Plastic Bristles	3"	Juno	14	4 ea	19.00/8.83
<b>Medium Ready Sweeps - Hardwood Block</b>						
367360TC	24" Medium Polypropylene Sweep	3"	Juno	03	4 ea	33.96/8.83
367366TC	24" Medium Sweep w/Stiff Polypropylene Bristles Center & Softer Border	3-1/4"	Juno	24*	4 ea	36.00/8.83
367386TC †	24" Medium Sweep w/Blue Plastic Bristles & Center Row Wire	3"	Juno	14	4 ea	19.00/8.83
367396TC	24" Medium Scraperbroom® w/Orange Flagged Plastic Bristles	3-1/4"	Juno	24	3 ea	9.00/6.18

† Resists most solvents and water



## Rough Ready Sweeps

- Come assembled with a 60" handle and 1-1/8" brace
- Wet or dry sweeping of rough surfaces
- 367395TC has a shaped steel blade for scraping caked-on debris



367395TC



367378TC



367372TC



365160TC

## Ready Sweep Replacements

- Ends fasten to the brush block while the center clamps around the handle (works w/24" and 36" blocks)
- Mounting hardware included



Prod No	Description	Trim	Handle	Color	Pack	Cs Wt/Cube
<b>Rough Ready Sweeps - Hardwood Block</b>						
367372TC	24" Rough Sweep w/Palmyra Bristles	4"	Juno	00	4 ea	33.00/0.71
367378TC †	24" Rough Sweep w/Stiff Maroon Plastic Bristles	3-1/4"	Juno	00*	4 ea	33.00/8.83
367390TC	24" Rough Sweep w/Heavy Duty Stiff Blue Plastic Bristles	3"	Juno	14	4 ea	19.00/8.83
367394TC**	24" Heavy and Rough Sweep w/Stiff Blue Plastic Bristles	4-1/4"	Juno	14	4 ea	26.00/8.83
367395TC	24" Rough Scraperbroom® w/Orange Plastic Bristles	3"	Juno	24	3 ea	15.24/8.83
<b>Ready Sweep Replacements</b>						
365160TC	Heavy Duty Wide Angle Brace	—	—	00	12 ea	4.56/1.68

† Resists most solvents and water

\*\*For concrete and street work



# FLOOR SWEEPING

## Fine

### Flagged Polypropylene

- For dry sweeping of dust and fine particles on smooth surfaces
- Soft, lightly crimped, flagged bristle



### Horsehair/Polypropylene

- For dry sweeping on smooth surfaces
- Combines sweeping effectiveness of horsehair with the durability of long-lasting, synthetic bristles



### Horsehair

- For dry sweeping on smooth surfaces



Handles sold separately; see pages 176-180 for handle recommendations



Prod No	Description	Bristle Length	Handle	Color	Pack	Cs Wt/Cube
<b>Flagged Polypropylene Sweeps – Hardwood Block</b>						
45013	18" Flagged Polypropylene Sweep	3"	Threaded	23, 24	12 ea	23.00/2.55
45014	24" Flagged Polypropylene Sweep	3"	Threaded	23, 24	12 ea	33.00/3.27
45016	36" Flagged Polypropylene Sweep	3"	Threaded	23, 24	6 ea	25.75/2.27
<b>Flagged Polypropylene Sweeps – Plastic Block</b>						
36204818	18" Flagged Polypropylene Sweep	3"	Threaded	23	12 ea	23.00/1.95
36204824	24" Flagged Polypropylene Sweep	3"	Threaded	23	12 ea	26.00/2.46
<b>Horsehair/Polypropylene Blend Sweeps – Hardwood Block</b>						
45030	18" Blended Horsehair Sweep	3"	Threaded	03	12 ea	23.00/2.05
45031	24" Blended Horsehair Sweep	3"	Threaded	03	12 ea	34.00/2.56
45032	36" Blended Horsehair Sweep	3"	Threaded	03	6 ea	23.32/2.27
<b>Horsehair/Polypropylene Blend Sweeps – Plastic Block</b>						
40561	18" Blended Horsehair Sweep	3"	Threaded	00	12 ea	25.00/2.14
40562	24" Blended Horsehair Sweep	3"	Threaded	00	12 ea	31.50/2.61
<b>100% Pure Horsehair Sweeps – Hardwood Block</b>						
3643418	18" Horsehair Sweep	2.88"	Threaded	03	12 ea	25.00/2.13
3643424	24" Horsehair Sweep	2.88"	Threaded	03	12 ea	28.50/3.05
3643436	36" Horsehair Sweep	2.88"	Threaded	03	6 ea	24.00/2.71



## Fine/Medium

### Polypropylene

- For wet or dry sweeping of fine dust or coarse debris
- Will not absorb moisture; resistant to most chemicals, acids and oils
- Durable synthetic sweep can be washed to extend performance life



362208P18



45073

### Tampico

- For dry sweeping on semi-smooth surfaces
- Tampico fiber resists heat and chemicals



40565



45054



**TOP SELLER**

Handles sold separately; see pages 176-180 for handle recommendations



Prod No	Description	Bristle Length	Handle	Color	Pack	Cs Wt/Cube
<b>Polypropylene Sweeps – Hardwood Block</b>						
45072	18" Polypropylene Sweep	3"	Threaded	03	12 ea	23.00/2.55
45073	24" Polypropylene Sweep	3"	Threaded	03	12 ea	30.00/2.61
45074	36" Polypropylene Sweep	3"	Threaded	03	6 ea	26.50/2.27
<b>Polypropylene Sweeps – Plastic Block</b>						
362208P18	18" Polypropylene Sweep	3"	Threaded	03	12 ea	23.00/2.02
362208P24	24" Polypropylene Sweep	3"	Threaded	03	12 ea	27.64/2.56
<b>Tampico Sweeps – Hardwood Block</b>						
45051	14" Tampico Sweep	3"	Threaded	03	12 ea	19.50/1.28
45053	18" Tampico Sweep	3"	Threaded	03	12 ea	25.50/2.60
45054	24" Tampico Sweep	3"	Threaded	03	12 ea	32.50/3.27
45056	36" Tampico Sweep	3"	Threaded	03	6 ea	25.00/2.27
<b>Tampico Sweeps – Plastic Block</b>						
40564	18" Tampico Sweep	3"	Threaded	00	12 ea	25.00/1.17
40565	24" Tampico Sweep	3"	Threaded	00	12 ea	34.00/2.61



# FLOOR SWEEPING

Fine/Medium

## Blended Border

- Horsehair blend border with Tampico center
- Great for dry sweeping on smooth or semi-smooth surfaces



45041



362024

## Flagged Border & Heavy Center

- For all around use on smooth and medium surfaces
- Heavy plastic center loosens dirt; flagged border controls dust
- Juno style blocks are made of solid hardwood and with the use of handle brace provide longer, stronger performance

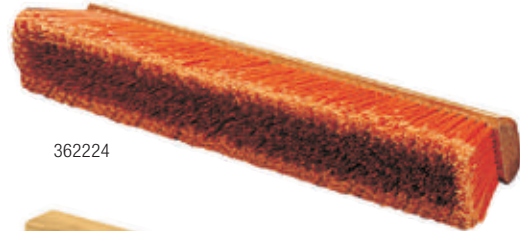

362224



36102224

Handles sold separately; see pages 176-180 for handle recommendations



Prod No	Description	Bristle Length	Handle	Color	Pack	Cs Wt/Cube
<b>Horsehair Blend Borders with Tampico Centers Sweeps – Hardwood Block</b>						
45040	18" Horsehair Blend Sweep with Tampico Center	3"	Threaded	03	12 ea	22.00/2.55
45041	24" Horsehair Blend Sweep with Tampico Center	3"	Threaded	03	12 ea	34.00/3.27
45043	36" Horsehair Blend Sweep with Tampico Center	3"	Threaded	03	6 ea	26.00/2.27
<b>Horsehair Blend Borders Sweeps with Polypropylene Centers – Hardwood Block</b>						
362018	18" Horsehair/Polypropylene Blend Sweep	3"	Threaded	03	12 ea	23.00/2.13
362024	24" Horsehair/Polypropylene Blend Sweep	3"	Threaded	03	12 ea	30.00/2.46
362036	36" Horsehair/Polypropylene Blend Sweep	3"	Threaded	03	6 ea	22.00/2.27
<b>Flagged Polypropylene Border with Heavy Polypropylene Center Sweeps – Hardwood Block</b>						
362218	18" Polypropylene Sweep with Polypropylene Center	3"	Threaded	24	12 ea	22.50/2.13
362224	24" Polypropylene Sweep with Polypropylene Center	3"	Threaded	24	12 ea	29.50/2.08
362236	36" Polypropylene Sweep with Polypropylene Center	3"	Threaded	24	6 ea	24.00/2.59
36102218	18" Juno Style Polypropylene Sweep with Polypropylene Center	3"	Juno	24	12 ea	22.50/2.13
36102224	24" Juno Style Polypropylene Sweep with Polypropylene Center	3"	Juno	24	12 ea	28.00/2.08
36102236	36" Juno Style Polypropylene Sweep with Polypropylene Center	3"	Juno	24	6 ea	20.50/2.27





## Medium

### Heavy Center Polypropylene

- For dry or wet sweeping on concrete, wood or any coarse surface
- Aggressive center sweeps heavy debris and medium border sweeps finer particles
- Not affected by petroleum products



366224

### Tampico with Wire Center

- For dry sweeping of rough or smooth paved or concrete surfaces
- Wire center to loosen and remove soil and debris



45136

### Horsehair/Polypropylene Blend with Wire Center

- Wet or dry sweeping of rough surfaces
- Wire center removes stubborn debris



3602424

Handles sold separately; see pages 176-180 for handle recommendations



Prod No	Description	Bristle Length	Handle	Color	Pack	Cs Wt/Cube
<b>Medium Polypropylene Border with Heavy Polypropylene Center Sweep – Hardwood Block</b>						
366224	24" Polypropylene Sweep with Heavy Polypropylene Center	3-1/4"	Threaded	03	12 ea	30.80/3.62
<b>Tampico with Wire Center Sweeps – Hardwood Block</b>						
45135	18" Tampico Sweep with Wire Center	3"	Threaded	00	12 ea	23.00/2.13
45136	24" Tampico Sweep with Wire Center	3"	Threaded	00	12 ea	33.00/2.46
3601236	36" Tampico Sweep with Wire Center	3"	Threaded	00	6 ea	28.02/2.59
<b>Horsehair/Polypropylene with Wire Center Sweeps – Hardwood Block</b>						
3602418	18" Horsehair/Polypropylene Sweep with Wire Center	3"	Threaded	03	12 ea	26.00/2.13
3602424	24" Horsehair/Polypropylene Sweep with Wire Center	3"	Threaded	03	12 ea	25.44/2.08
3602436	36" Horsehair/Polypropylene Sweep with Wire Center	3"	Threaded	03	6 ea	26.00/2.27



# FLOOR SWEEPING

## Heavy

### Polypropylene

- Wet or dry sweeping of rough surfaces
- Not affected by water or petroleum products



### Natural Fiber Palmyra

- Wet or dry sweeping on rough surfaces under harsh conditions
- Greasy concrete or asphalt



### Juno Style Polypropylene

- Wet or dry sweeping of rough surfaces
- Not affected by water or petroleum products
- Bolt-on handle system for secure handle attachment



Handles sold separately; see pages 176-180 for handle recommendations



Prod No	Description	Bristle Length	Handle	Color	Pack	Cs Wt/Cube
<b>Heavy Polypropylene Sweeps – Hardwood Block</b>						
45201	18" Heavy Polypropylene Sweep	3-1/4"	Threaded	01	12 ea	27.50/1.99
367618	18" Heavy Polypropylene Sweep	3-1/4"	Threaded	24	12 ea	20.00/2.27
45202	24" Heavy Polypropylene Sweep with Brace	3-1/4"	Threaded	01	12 ea	36.50/2.61
367624	24" Heavy Polypropylene Sweep with Brace	3-1/4"	Threaded	24	12 ea	29.26/2.46
45204	36" Heavy Polypropylene Sweep with Brace	3-1/4"	Threaded	01	6 ea	32.25/2.59
<b>Heavy Polypropylene Sweeps – Plastic Block</b>						
36207218	18" Heavy Polypropylene Sweep	3-1/4"	Threaded	00	12 ea	21.60/2.01
36207224	24" Heavy Polypropylene Sweep	3-1/4"	Threaded	00	12 ea	35.52/2.63
<b>Natural Fiber Palmyra Sweeps – Hardwood Block</b>						
45221	18" Palmyra Floor Sweep	4"	Threaded	00	12 ea	22.56/2.60
45222	24" Palmyra Floor Sweep with Brace	4"	Threaded	00	12 ea	43.00/3.63
45224	36" Palmyra Floor Sweep with Brace	4"	Threaded	00	6 ea	34.00/2.59
<b>Juno Style Polypropylene Sweep – Hardwood Block</b>						
36107624	24" Juno Style Polypropylene Sweep	3-1/4"	Juno	24	12 ea	29.00/3.57



## Scraperbroom®

- Wet or dry sweeping of rough surfaces
- Shaped steel blade for scraping caked-on debris
- Includes handle connection, handle and brace

369524



## Heavy Polypropylene

- Wet or dry sweeping on rough concrete or asphalt in harsher environments
- Durable, tough, long-wearing crimped bristles are perfect for street crews, construction, and other demanding work sites

36114016



361116



36113016



## Palmyra

- Wet or dry sweeping on rough surfaces under harsh conditions; greasy concrete or asphalt

36219416



Handles sold separately; see pages 176-180 for handle recommendations



Prod No	Description	Bristle Length	Handle	Color	Pack	Cs Wt/Cube
<b>Scraperbroom Sweep – Hardwood Block &amp; Scraper</b>						
369524	24" Polypropylene Sweep with Steel Scraper Blade	3-1/4"	Juno	24	3 ea	16.00/1.16
<b>Heavy Polypropylene Sweeps – Hardwood Block</b>						
36114016	16" Heavy Polypropylene Sweep	4-1/2"	Tapered/Threaded	14	12 ea	34.00/2.60
36113016	16" Heavy Polypropylene Sweep	5-1/8"	Tapered/Threaded	01	12 ea	27.50/3.56
361116	16" Heavy Polypropylene Sweep	5-1/8"	Tapered/Threaded	24	12 ea	28.00/3.00
36114018	18" Heavy Polypropylene Sweep	4-1/2"	Tapered/Threaded	14	6 ea	18.14/2.30
36113018	18" Heavy Polypropylene Sweep	5-1/8"	Tapered/Threaded	01	6 ea	16.50/1.99
361118	18" Heavy Polypropylene Sweep	5-1/8"	Tapered/Threaded	24	6 ea	18.00/2.46
36114024	24" Heavy Polypropylene Sweep	4-1/2"	Tapered/Threaded	14	6 ea	22.50/2.39
36113024	24" Heavy Polypropylene Sweep	5-1/8"	Tapered/Threaded	01	6 ea	21.00/2.08
361124	24" Heavy Polypropylene Sweep	5-1/8"	Tapered/Threaded	24	6 ea	22.00/2.08
<b>Palmyra Sweep – Hardwood Block</b>						
36219416	16" Palmyra Stalk Street Broom	6-1/4"	Tapered/Threaded	00	12 ea	17.00/3.22



# FLOOR SCRUBBING

## Dual Surface® Scrubs

- Floor scrubs are made with three different brush surfaces for cleaning at different angles
- Non-absorbent plastic blocks and crimped synthetic bristles wash easily and prevent gathering of mold and mildew
- 36197 has Flo-Thru channels
- 36190 and 40421 have squeegee for water control
- 40422 has end bristles to provide efficient scrubbing of baseboards and corners



**TOP SELLER**

40423



Handles sold separately; see pages 176-180 for handle recommendations

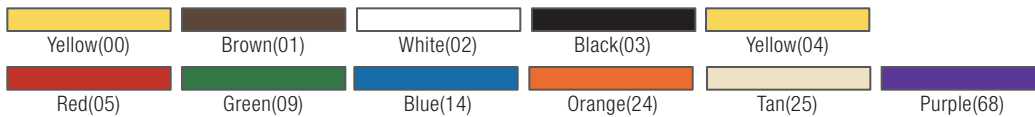

Prod No	Description	Bristle Length	Handle	Color	Pack	Cs Wt/Cube
<b>Dual Surface Floor Scrubs</b>						
36197	10" Dual Surface Scrub Brush	2"	Flo-Thru/Threaded	14	12 ea	14.14/1.95
36190	10" Dual Surface Scrub Brush with Squeegee	2"	Threaded	14	12 ea	13.75/1.56
40423	10" Hi-Lo Floor Scrub Brush	1-3/4"	Threaded	01, 02, 03, 04, 05, 09, 14, 24, 25, 68	12 ea	16.00/1.26
40421	10" Hi-Lo Floor Scrub Brush with Squeegee	1-3/4"	Threaded	00	12 ea	16.20/1.26
40422	10" Hi-Lo Scrub Brush with End Bristles	1-3/4"	Threaded	00, 05, 09, 14	12 ea	16.45/1.34



## Natural Fiber Deck Scrubs

- Palmyra bristles are perfect for scrubbing rough surfaces or etching floors
- Tampico bristles provide durability and high resistance to solvents and heat
- 36395 palmyra deck scrub has durable rubber squeegee built into block



## Polypropylene Deck Scrubs

- Crimped polypropylene bristles are chemical resistant and hold solutions well
- Synthetic bristle is not affected by solvents or acids; good for general scrubbing



## Silicone Carbide Infused Nylon Deck Scrub

- Silicone carbide infused nylon for aggressive floor scrubbing and stripping
- Use in corners, along baseboards and areas where floor machines can't reach



**Handles sold separately; see pages 176-180 for handle recommendations**



Prod No	Description	Bristle Length	Handle	Color	Pack	Cs Wt/Cube
<b>Natural Fiber Deck Scrubs – Hardwood Block</b>						
36192	10" Palmyra Deck Scrub	2"	Threaded/Tapered	00	12 ea	12.00/0.87
36292	12" Palmyra Deck Scrub	2"	Threaded/Tapered	00	12 ea	15.00/0.97
36395	14" Palmyra Deck Scrub with Squeegee	2"	Threaded/Tapered	00	12 ea	15.75/1.49
36193	10" Tampico Deck Scrub	2"	Threaded/Tapered	00	12 ea	11.75/0.82
<b>Silicone Carbide Impregnated Nylon Deck Scrub – Hardwood Block</b>						
36191	10" Silicone Carbide Impregnated Nylon Deck Scrub	1-3/4"	Threaded/Tapered	00	12 ea	13.00/0.52
<b>Polypropylene Deck Scrubs – Hardwood Block</b>						
36175	10" Stiff Polypropylene Deck Scrub	1-3/4"	Threaded/Tapered	14	12 ea	11.50/0.75
36193P	10" Polypropylene Deck Scrub	2"	Threaded/Tapered	14	12 ea	11.50/0.78
36193MX	10" Polypropylene Deck Scrub	2"	Threaded/Tapered	04	12 ea	12.00/0.52
36275	12" Stiff Polypropylene Deck Scrub	1-3/4"	Threaded/Tapered	14	12 ea	14.50/0.97
36293P	12" Polypropylene Deck Scrub	2"	Threaded/Tapered	14	12 ea	14.50/0.97

# FLOOR SCRUBBING

## Swivel Scrubs

- Swivels onto its side to clean baseboards, walls, around equipment and other hard-to-reach areas
- The low profile design helps get into places that would be impossible with a normal floor brush

### Nylon Grit Bristle is best for:

- General Swivel Scrub for routine scrubbing
- Power Scrub for heavy scrubbing and stripping wax build up

### Polyester Bristle Swivel Scrub is best for:

- Polyester bristle resists water, high temperatures, acids, alkalis and most cleaning solutions
- Polyester bristle is perfect for everyday use in food processing, schools, or health care facilities.

### Polypropylene Bristle Swivel Scrubs are best for

- General scrubbing



3638831



365310



365300

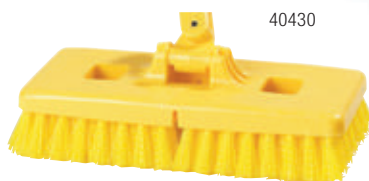

40430

Standard(00)	Yellow(00)*	White(02)	Black(03)	Yellow(04)
Red(05)	Green(09)	Blue(14)	Light Green(14)*	Rust(27)

Prod No	Description	Bristle Length	Handle	Color	Pack	Cs Wt/Cube
<b>Swivel Scrubs – Plastic Block</b>						
365300	8" General Swivel Scrub with Nylon Grit Bristles	1-1/2"	Threaded	14*	12 ea	9.50/0.68
365310	8" Power Swivel Scrub with Heavy Nylon Grit Bristles	1-1/2"	Threaded	27	12 ea	9.50/0.68
3638831	8" Swivel Scrub with Polyester Bristles	1"	Threaded	02, 03, 04, 05, 09, 14	12 ea	8.86/0.70
40430	9" All-Around Scrub Brush with Stiff Polypropylene Bristles	2"	Threaded	00*	12 ea	13.00/1.83
36219663	8" Polypropylene Swivel Scrub with 48" Handle	1-1/2"	Includes Handle	00	4 ea	6.12/1.84





## Scrub Pads & Holder

- Swivel pad holder is great for cleaning baseboards, floor edges, underneath fixtures and ceramic tile



365380 Pad Holder  
w/40724 Scrubber Pad



40724

40725

## Tile & Grout Scrubs

### 365320 Swivel Grout Brush

- Bevel cut bristles to reach into grout lines
- Pivoting head lets brush glide along grout line and access corners and other hard-to-reach areas
- Stiff crimped nylon bristles remove dirt, grime and residue



41323

### 41323 Dual-Purpose Tile & Grout Brush

- FDA compliant materials used in block and bristles
- This dual-purpose brush, with molded-in scraper, can be held in your hand or used with a handle in two different positions
- Stiff crimped nylon bristles remove dirt, grime and residue



365320

### 365351 Grout Brush

- Great for cleaning tile and grout in small areas



365351

Handles sold separately; see pages 176-180 for handle recommendations

Standard(00)	White(02)	Black(03)	Yellow(04)	Red(05)	Green(09)	Blue(14)
--------------	-----------	-----------	------------	---------	-----------	----------

Prod No	Description	Bristle Length	Handle	Color	Pack	Cs Wt/Cube
<b>Scrub Pads &amp; Holder</b>						
40724	10" x 4-5/8" x 1" Nylon Fine Scrub Pad, 5 ea/pack, 4 pks/case	—	—	00	4 pks	2.50/0.70
40725	10" x 4-5/8" x 1" Nylon Medium Scrub Pad, 5 ea/pack, 4 pks/case	—	—	00	4 pks	2.80/0.70
365380	Swivel Pad Holder	—	—	14	12 ea	4.00/0.33
<b>Tile &amp; Grout Scrubs</b>						
365320	7-1/2" Swivel Head Grout Line Brush, Nylon Bristle	1" and 1-1/2"	Threaded/Tapered	03	12 ea	3.60/0.33
365351	8-1/2" Grout Brush, Nylon Bristle	1-1/4"	—	03	24 ea	2.00/0.26
41323	9" Tile & Grout Brush	1"	Threaded	02, 04, 05, 09, 14	12 ea	7.50/0.44



# FLOOR ACCESSORIES

## Floor Drain Brushes & Handles

- Brushes available in 4 sizes and made of long lasting polypropylene bristles
- Special female threaded handle accepts floor drain brushes only to prevent cross-contamination
- "USE FOR FLOOR DRAIN ONLY" is prominently imprinted in English and Spanish on the plastic drain handle (sold separately)



## Drain Opener

- Convenient, sanitary way to remove floor drain covers
- Easy to use, simply insert into drain and twist to remove drain cover and drain basket
- One-piece construction for easy sanitizing



## Baseboard Scrubber

- Triangular design cleans baseboards, moldings and floor edges
- Polypropylene for general scrubbing



361966

Handles sold separately; see pages 176-180 for handle recommendations



Prod No	Description	Bristle Length	Handle	Color	Pack	Cs Wt/Cube
<b>Floor Drain Brushes &amp; Handles</b>						
40146	3" Floor Drain Brush	3"	Female Threaded	00	6 ea	4.00/0.31
40147	4" Floor Drain Brush	4"	Female Threaded	00	6 ea	6.00/0.44
41093	5" Floor Drain Brush	5"	Female Threaded	00	6 ea	3.25/0.77
40148	6" Floor Drain Brush	6"	Female Threaded	00	6 ea	3.55/1.07
40236	36" Plastic Drain Brush Handle	—	—	00	12 ea	18.00/0.55
40237	48" Plastic Drain Brush Handle	—	—	00	12 ea	22.00/0.76
40238	60" Plastic Drain Brush Handle	—	—	00	12 ea	27.00/0.91
<b>Drain Opener</b>						
40144	Drain Opener	—	—	02	12 ea	6.50/0.55
<b>Baseboard Scrubber – Hardwood Block</b>						
361966	Triangle Scrubber with Polypropylene Bristles	1-1/8"	Threaded	14	12 ea	14.42/1.10





## Floor Scrapers

- Heavy gauge stainless steel blade resists rust; provides aggressive scraping action for concrete, tile, and resilient floors
- “V” shaped blade construction maintains the optimal scraping angle and also collects debris



## Carpet & Upholstery Brushes

### Pile Brushes

- Professionally rejuvenates carpet pile



### Carpet Rake

- Lift carpet pile and restore a fresh look to carpet



Handles sold separately; see pages 176-180 for handle recommendations



Prod No	Description	Bristle Length	Handle	Color	Pack	Cs Wt/Cube
<b>Floor Scrapers</b>						
41619	8" Floor Scraper with Polycarbonate Threaded Handle Socket	—	Threaded	00	12 ea	9.50/0.74
41078	8" Floor Scraper with Tapered Zinc Handle Socket	—	Tapered	00	12 ea	13.75/0.74
<b>Carpet Rake – Plastic Block</b>						
45751	18" Carpet Rake with Nylon Bristles and 54" Handle	1-3/8"	—	00	12 ea	25.40/1.71
<b>Pile Brushes</b>						
36297	18" Pile Brush, Nylon Bristles	1-3/4"	Tapered	03	12 ea	12.50/1.30
36397	18" Pile Brush, Extra-Stiff Nylon Bristle	1-1/8"	Tapered	00	12 ea	12.00/1.30



# SQUEEGEES

Count on Carlisle to provide **reliable tools** to keep your surfaces clean and bright. Carlisle has considered every squeegee project and our product offering will meet your needs. Get the job done with **floor squeegees and brushes**.



**TOP SELLER**

## Double Foam Squeegees with Metal Frame

- Rugged black neoprene for heavy-duty removal of dirt, water and debris on uneven surfaces
- Common applications include restaurant, light industrial warehouses and other surfaces with uneven surfaces and textured tile.
- Medium flexibility and non-marking

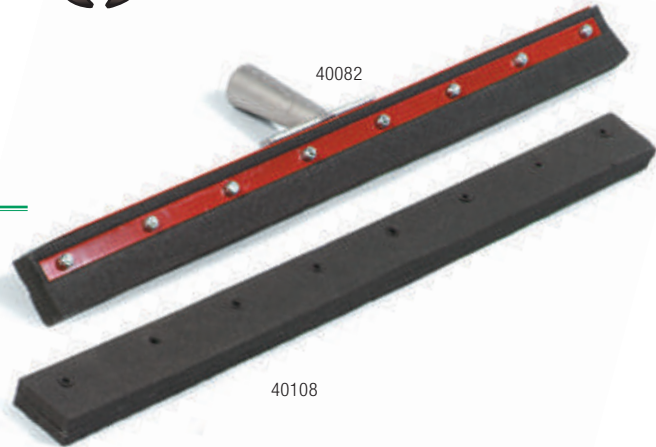

## Double Moss Foam Rubber with Metal Frame

- Moss Foam squeegee is designed for non-textured, uneven, grouted and smooth surface floors
- Red Moss Foam is fat and oil resistant
- Black Moss Foam (366724) is ideal for general purpose cleaning in schools and commercial facilities.



Handles sold separately; see pages 176-180 for handle recommendations

Prod No	Description	Handle Style	Color	Pack	Cs Wt/Cube
<b>Double Foam Squeegee with Metal Frame</b>					
40081	18" Double Foam Neoprene Rubber	1-1/8" Dia Only - Tapered	00	6 ea	9.20/0.77
40082	24" Double Foam Neoprene Rubber	1-1/8" Dia Only - Tapered	00	6 ea	14.00/1.00
40083	30" Double Foam Neoprene Rubber	1-1/8" Dia Only - Tapered	00	6 ea	14.20/1.25
40107	18" Double Foam Neoprene Rubber Refill	—	00	12 ea	1.55/0.20
40108	24" Double Foam Neoprene Rubber Refill	—	00	12 ea	2.01/0.26
40109	30" Double Foam Neoprene Rubber Refill	—	00	12 ea	3.00/0.32
<b>Double Moss Foam Rubber Squeegee with Metal Frame</b>					
366318	18" Soft Black Foam Rubber	15/16" Dia Only - Tapered	00	10 ea	5.80/0.54
366324	22" Soft Black Foam Rubber	15/16" Dia Only - Tapered	00	10 ea	8.30/1.03
366724	22" Reinforced Soft Black Foam Rubber	15/16" Dia Only - Tapered	00	10 ea	12.00/1.03
366824	22" Soft Black Heavy-Duty Foam Rubber	Threaded	00	10 ea	12.00/1.03
366330	30" Reinforced Soft Black Foam Rubber	15/16" Dia Only - Tapered	00	10 ea	16.00/1.58
366530	30" Reinforced Red Foam Rubber	15/16" Dia Only - Tapered	00	10 ea	16.00/1.58



## Double Foam Rubber Squeegee with Plastic Frame

- All plastic construction will not rust or bend and helps prevent hazard sparks when cleaning-up flammable fluids
- High-quality, double foam for full color-coded systems to prevent cross contamination between work areas
- Available in colors to support HACCP compliance
- For uneven or smooth surfaces



## Double Moss Foam Rubber Squeegee with Plastic Frame

- Soft, double foam is fat and oil resistant
- All plastic construction will not rust or bend and helps prevent hazard sparks when cleaning-up flammable fluids
- For uneven or smooth surfaces



## Double Foam Rubber Squeegee & Brush with Plastic Frame

- Use the brush side to remove stubborn debris, dirt and soil; use the squeegee side to dry the floor
- All plastic construction will not rust or bend and helps prevent hazard sparks when cleaning-up flammable fluids
- For use in high traffic areas including restrooms and kitchens

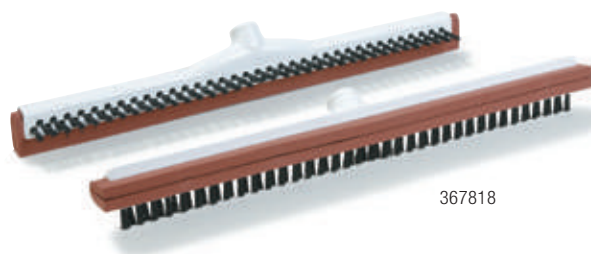

Handles sold separately; see pages 176-180 for handle recommendations

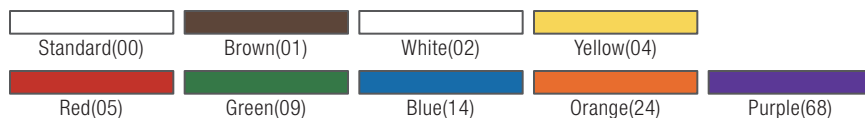

Prod No	Description	Handle Style	Color	Pack	Cs Wt/Cube
<b>Double Foam Rubber Squeegee with Plastic Frame</b>					
41567	18" Double Foam Rubber Floor Squeegee	Threaded	01, 02, 04, 05, 09, 14, 24, 68	6 ea	4.40/0.66
41568	24" Double Foam Rubber Floor Squeegee	Threaded	01, 02, 04, 05, 09, 14, 24, 68	6 ea	5.72/0.85
<b>Double Moss Foam Rubber Squeegee with Plastic Frame</b>					
366222	22" Soft Black Foam Rubber	15/16" Dia Only - Tapered	00	10 ea	8.75/1.34
366230	30" Soft Black Foam Rubber	15/16" Dia Only - Tapered	00	10 ea	10.60/1.83
366918	18" Red Foam Rubber	15/16" Dia Only - Tapered	00	10 ea	7.50/1.34
366922	22" Red Foam Rubber	15/16" Dia Only - Tapered	00	10 ea	10.60/1.97
366930	30" Red Foam Rubber	15/16" Dia Only - Tapered	00	10 ea	27.96/3.21
<b>Double Foam Rubber Squeegee/Brush with Plastic Frame</b>					
367818	18" Red Double Foam Red Rubber	Threaded	00	10 ea	6.30/1.05



# SQUEEGEES

## One-Piece Rubber Squeegee with Plastic Frame

- Economical choice for lighter duty applications and shallow grout
- All plastic construction will not rust or bend and helps prevent hazard sparks when cleaning-up flammable fluids
- Available in colors to support HACCP compliance
- For smooth surfaces



## Curved End Rubber Squeegee with Metal Frame

- Curved end to control liquid and debris including harmful chemicals
- For heavy industrial applications including manufacturing facilities or other surfaces that may commonly use caustic chemicals, strong solvents and oils
- For smooth surfaces
- Rubber is durable for heavy duty use including chemical and solvent resistant; red gum rubber is non-marking

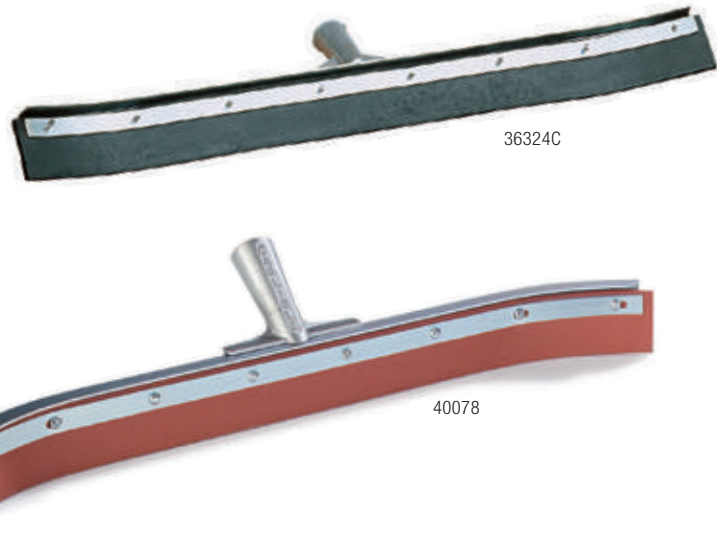

Handles sold separately; see pages 176-180 for handle recommendations

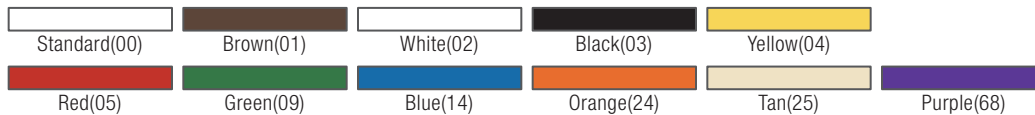

Prod No	Description	Handle Style	Color	Pack	Cs Wt/Cube
<b>One-Piece Rubber Squeegee with Plastic Frame</b>					
36567	20" Solid, One-Piece Rubber Squeegee	Threaded	01, 02, 03, 04, 05, 09, 14, 24, 25, 68	6 ea	5.50/0.51
36568	24" Solid, One-Piece Rubber Squeegee	Threaded	01, 02, 03, 04, 05, 09, 14, 24, 68	6 ea	6.50/0.61
<b>Curved End Rubber Squeegee with Metal Frame</b>					
36324C	24" Curved End Black Rubber Squeegee	1-1/8" Dia Only - Tapered	00	6 ea	15.00/0.35
36336C	36" Curved End Black Rubber Squeegee	1-1/8" Dia Only - Tapered	00	6 ea	22.00/0.37
40078	24" Curved End Red Gum Rubber Squeegee	1-1/8" Dia Only - Tapered	00	6 ea	15.00/1.00



## Straight Rubber Squeegee with Metal Frame

- For heavy industrial applications including manufacturing facilities or other surfaces that may commonly use caustic chemicals, strong solvents and oils
- Red and black rubber is durable for heavy duty use including chemical and solvent resistant; red gum rubber is non-marking
- 366124 has gray vinyl with non-sparking frame for use with petroleum products

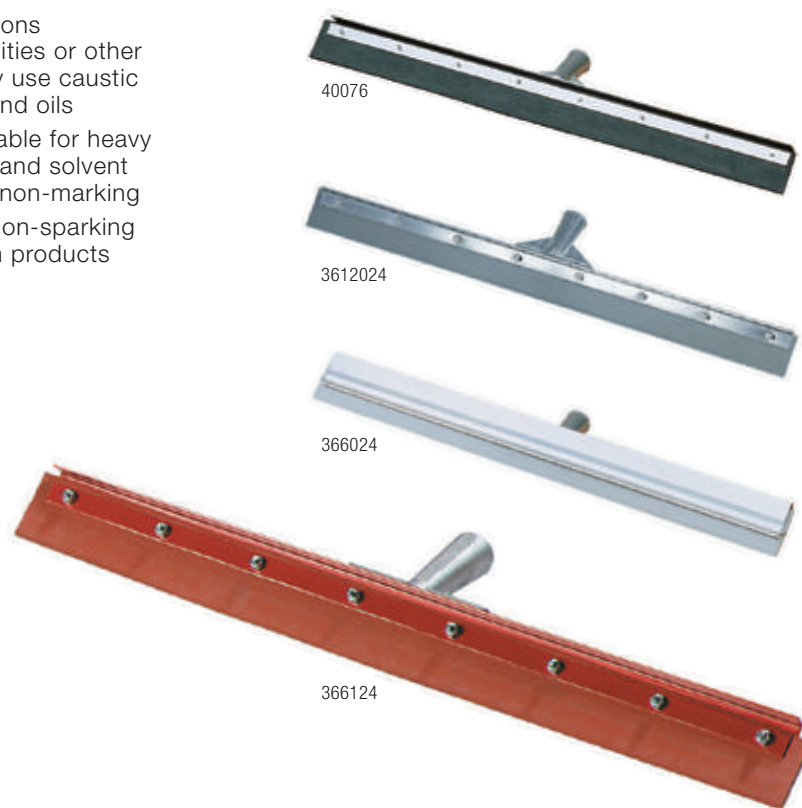

Handles sold separately; see pages 176-180 for handle recommendations

Standard(00)

Prod No	Description	Handle Style	Color	Pack	Cs Wt/Cube
<b>Straight Rubber Squeegee with Metal Frame &amp; Powder Coating</b>					
40075	18" Straight Red Gum Squeegee	1-1/8" Dia Only - Tapered	00	6 ea	10.95/0.77
40076	24" Straight Red Gum Squeegee	1-1/8" Dia Only - Tapered	00	6 ea	14.15/1.04
40077	36" Straight Red Gum Squeegee	1-1/8" Dia Only - Tapered	00	6 ea	23.00/1.49
<b>Straight Rubber Squeegee with Metal Frame</b>					
3612018	18" Straight Blade Black Rubber Squeegee	1-1/8" Dia Only - Tapered	00	6 ea	2.30/0.85
3612024	24" Straight Blade Black Rubber Squeegee	1-1/8" Dia Only - Tapered	00	6 ea	16.00/0.26
3612036	36" Straight Blade Black Rubber Squeegee	1-1/8" Dia Only - Tapered	00	6 ea	22.02/0.20
366024	24" Straight Gray Vinyl Blade Squeegee	1-1/8" Dia Only - Tapered	00	6 ea	15.48/0.20
366036	36" Straight Gray Vinyl Blade Squeegee	1-1/8" Dia Only - Tapered	00	6 ea	22.02/0.39
<b>Straight Rubber Squeegee with Non-Sparking Metal Frame</b>					
366124	24" Push/Pull Vinyl Squeegee	1-1/8" Dia Only - Tapered	00	6 ea	14.52/0.26



# SQUEEGEES

Only Carlisle offers this **unique brush and squeegee combination** designed and manufactured as one rubber piece.

## VersaClean™ Brushes

- For everyday cleaning in a food and beverage environment
- Scrub heavy tile, grout or even rough concrete surfaces clean; can be used as an agitator for stubborn spots
- Unique electrostatic pull-broom action will pick up light flyaway debris from carpets, rugs, or bare floors
- Built-in one-piece squeegee cleans up wet surfaces quickly and discourages bacteria growth
- Resists most chemicals and withstands temperatures up to 212°F; Compatible with autoclave machines



Squeegee cleans up wet surfaces quickly.



Picks up light debris from carpet, rugs, or bare floors.



Use as an agitator for stubborn spots on tile or concrete.



Built-in one-piece squeegee works on rough concrete surface.

Handles sold separately; see pages 176-180 for handle recommendations



Black(03)

Prod No	Description	Handle Style	Color	Pack	Cs Wt/Cube
<b>VersaClean Brush &amp; Squeegee</b>					
36592 <span style="color: green;">▲</span>	VersaClean Brush with Squeegee	Threaded	03	12 ea	11.00/1.08
36596 <span style="color: green;">▲</span>	VersaClean Brush with Squeegee	Threaded	03	12 ea	14.00/1.42

NSF Listed products are designated with a ▲ and may be prefixed with an N

# MOPPING



## Microfiber Dry Mop

- Looped end with microfiber center clings to dust like a magnet
- Quickly attaches itself to aluminum head
- Machine washable



## Launderable Dust Mops

- Hospital Grade
- Pre-laundered; synthetic backing and looped-end construction for less lint and effective dust mopping
- Blue synthetic backing with key hole and ties withstands repeated laundering; sewn construction for longer life



## Microfiber Wet Mop

- Dries quicker, cleans more thoroughly than a standard mop
- Machine washable and still effective with over 500 washings
- Quickly attaches itself to aluminum head



Prod No	Description	Color	Pack	Cs Wt/Cube
<b>Microfiber Dry Mops</b>				
3633118	18" Microfiber Dry Mop Pad	14	12 ea	3.10/0.41
3633124	24" Microfiber Dry Mop Pad	14	12 ea	4.25/0.80
3633136	36" Microfiber Dry Mop Pad	14	12 ea	6.55/0.90
<b>Launderable Dust Mops – Fits 5" Frame</b>				
3648824	24" Blended Launderable Dust Mop	14	12 ea	15.96/1.36
3648836	36" Blended Launderable Dust Mop	14	12 ea	21.96/1.61
<b>Microfiber Wet Mops</b>				
3633218	18" Microfiber Wet Mop Pad	04, 05, 09, 14	12 ea	2.10/0.21
3633224	24" Microfiber Wet Mop Pad	14	12 ea	2.80/0.33



# MOPPING

## Tie-Back Dust Mops & Frames

- An economical choice for a cotton dust mop with full tie back
- Frame is constructed of heavy gauge metal
- Zinc plating reduces rust and corrosion
- Use dust mop handle (sold separately) on page 101



## Wedge Dust Mop

- Cotton dust mop with frame
- Threaded handle hole
- For hard-to-reach areas
- Use dust mop handle (sold separately) on page 101



Handles sold separately; see pages  
176-180 for handle recommendations

Standard(00)

Prod No	Description	Handle	Color	Pack	Cs Wt/Cube
<b>Value Line Tie Back Dust Mops – Fits 3" Frame</b>					
3647324	24" Dust Mop	Dust Mop	00	12 ea	11.04/0.85
3647336	36" Dust Mop	Dust Mop	00	12 ea	21.96/2.00
<b>Value Line Tie Back Dust Mops – Fits 5" Frame</b>					
3647524	24" Dust Mop	Dust Mop	00	12 ea	15.96/1.08
3647536	36" Dust Mop	Dust Mop	00	12 ea	18.96/1.42
3647548	48" Dust Mop	Dust Mop	00	12 ea	24.96/1.83
<b>Dust Mop Frames</b>					
41672	24" Mop Frame, 5" Wide	Clip-On/Flexible	00	12 ea	12.75/0.42
41673	36" Mop Frame, 5" Wide	Clip-On/Flexible	00	12 ea	17.00/0.62
3647248	48" Mop Frame, 5" Wide	Clip-On/Flexible	00	12 ea	24.00/1.01
<b>Wedge Dust Mop</b>					
36490	Wedge Dust Mop	Threaded	00	12 ea	7.20/1.07
36490R	Wedge Mop Replacement	Threaded	00	12 ea	5.04/1.07





## Microfiber Charging Bucket

- Rectangular bucket with 6 gallon capacity
- Includes snap-on lid and clip-on plastic sleeve for window washers and squeegees
- Molded-in graduations
- Ergonomic handle for easy transportation



## Aluminum Flat Mop Heads & Telescoping Handle For Microfiber

### Mop Heads

- Heavy duty construction and swivel mechanism
- For use with wet and dry microfiber flat mops

### Handle

- 70" telescopic handle for use with Aluminum flat mop heads



Handles sold separately; see pages 176-180 for handle recommendations



Prod No	Description	Handle	Color	Pack	Cs Wt/Cube
<b>Rectangular Microfiber Bucket</b>					
3633019	6 gal Rectangular Microfiber Bucket	—	23	3 ea	12.50/1.15
<b>Aluminum Flat Mop Heads</b>					
3633519	18" Aluminum Flat Mop Head	3633670	00	12 ea	8.60/0.98
3633525	24" Aluminum Flat Mop Head	3633670	00	12 ea	10.90/1.25
3633537	36" Aluminum Flat Mop Head	3633670	00	12 ea	13.30/1.92
<b>Telescoping Handle</b>					
3633670	70" Aluminum Telescopic Handle	—	00	12 ea	3.70/1.20

# MOPPING

Use the guide below to help choose the right products for your floor care needs.

## General Mopping

Choose mops with high absorbency, release and durability. If laundering facilities are available, it is beneficial to take advantage of launderable mops to save money. For performance and durability choose a synthetic blend or rayon mop with looped end and woven tailbands.

## Yarn

- It is important to choose the right mop in order to get maximum efficiency
- Some yarns naturally perform specific cleaning tasks better than others

## Yarn Ply

- Yarn ply is the number of strands twisted together to make a single yarn strand
- Although more plies give added strength, it does not always mean higher quality yarn
- More strands can add durability, but they decrease absorbency
- It is better & more cost effective to choose a higher quality yarn than a high ply, low quality yarn

## Twist

- The “twist” of a yarn is a result of how tightly the fiber strands are wound together
- A tightly twisted yarn might have more strength & last longer, but it can have less absorbency
- The best choice is determined by the type & quality of the yarn, as well as the mop’s construction
- Mops with looped-end construction allow the yarn to have a loose twist without the fraying

## Finish Mopping

For finish mopping applications look for a rayon or synthetic mop. These mops offer high absorbency and release. To make sure you are achieving maximum floor coverage with minimal streaking choose a tailband and looped end yarn.

	Advantages	Disadvantages	Use
<b>Cotton</b>	Good absorption & retention with limited shrinkage & a low initial cost.	Break-in period required. Slow drying yarn leads to mildew & deterioration. Lints.	Designed for general use. Scrubbing & cleaning up liquids.
<b>Synthetic</b>	Long stable fiber offers excellent tensile strength without linting.	Higher cost. Poor absorption.	Rough surfaces.
<b>Cotton Synthetic Blend</b>	Excellent choice for performance, price & durability. Synthetic fiber offers durability & color options.	Possible shrinkage.	Requested by professionals who require a better, longer lasting mop.
<b>Rayon</b>	Absorbs quickly with easy release. Dries fast & is mildew resistant. Cleaner yarn with less linting.	Shrinks when laundered and has less liquid retention.	Use for applying liquids such as disinfectant or floor finishes.



## Band Styles



**Wide Band**  
Vinyl coated mesh. 5" Width



**Narrow Band**  
Textured polyester tape. 1-1/4" Width



**Screw Top**  
Textured polyester tape with a metal screw on attachment. 1.25" Width

## Handle — Jaw Style



## Handle — Quick Change/Release



## Handle — Screw In





## Cut-End Or Looped-End



### Cut-End

- Cut-end mops are the most popular
- Low purchase price compared to looped end
- Cannot be laundered
- Cover less area per pass when mopping

### Looped-End

- Superior performance & lasts longer than cut-end mops
- Launderable
- Tailband style gives better mopping coverage
- Looped-ends prevent fraying & unraveling so you can achieve reduced labor costs & replace mops less often
- Although the initial investment is more than a cut-end style, the life expectancy makes looped-end mops a more economical choice

## How We Rate Our Mops

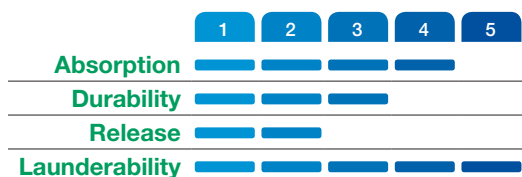

### Absorbency

The absorbency of a mop refers to the ability to pick up and retain liquid. Higher levels allow faster floor drying times, leading to greater productivity and safety. Rayon and cotton yarns have the highest absorbency.

### Durability

Mop durability is a measure of how long it will last or perform before needing replacement. Synthetic and blended mops are the most durable.

### Release/Retention

Release is the ability of a mop to disperse liquid onto the floor or during wringing. Higher levels allow faster and more complete wringing, as well as more efficient application of cleaning solutions on the floor.

### Launderability

The launderability is based on the number of washing cycles it can withstand before the construction of the mop is degraded. Synthetic and blended fiber mops have the highest levels of launderability.

## Sizes Are Indicated By Tailband Color

Small



Medium



Large



X-Large



### Brick Packs

Mops that are available in brick packs reduce cube up to 62%

(Item #s ending with a "B" are sold in brick packs)





# MOPPING

## Synthetic/Cotton Blend Looped-End

- Maximum Durability
- 50-75 uses per mop
- S, M, and L are available in brick packs

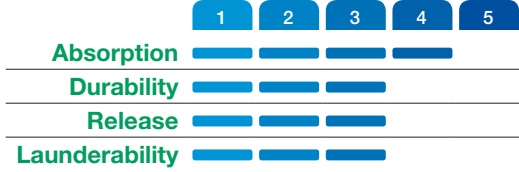

## 4 Ply Cotton Looped-End

- All purpose for general cleaning
- Packaged in brick packs

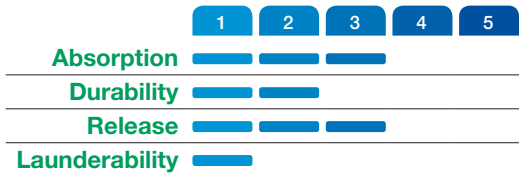

Handles sold separately; see pages 176-180 for handle recommendations



Prod No	Description	Handle	Color	Pack	Cs Wt/Cube
<b>Synthetic/Cotton Blend (Wide Band)</b>					
369412B	Small Yellow Wide Band Mop with White Yarn	Jaw Style	00	12 ea	8.00/0.68
369442B	Small Yellow Wide Band Mop with Blue Yarn	Jaw Style	14	12 ea	8.00/0.68
369472B	Small Yellow Wide Band Mop with Green Yarn	Jaw Style	09	12 ea	8.00/0.68
369418B	Medium Green Wide Band Mop with White Yarn	Jaw Style	00	12 ea	12.5/0.68
369448B	Medium Green Wide Band Mop with Blue Yarn	Jaw Style	14	12 ea	12.50/0.68
369478B	Medium Green Wide Band Mop with Green Yarn	Jaw Style	09	12 ea	12.50/0.74
369424B	Large Red Wide Band Mop with White Yarn	Jaw Style	00	12 ea	17.20/0.74
369454B	Large Red Wide Band Mop with Blue Yarn	Jaw Style	14	12 ea	17.20/0.74
369484B	Large Red Wide Band Mop with Green Yarn	Jaw Style	09	12 ea	17.20/0.74
369430	X-Large Blue Wide Band Mop with White Yarn	Jaw Style	00	12 ea	23.04/2.71
369460	X-Large Blue Wide Band Mop with Blue Yarn	Jaw Style	14	12 ea	23.04/2.92
<b>4-Ply Cotton (Wide Band)</b>					
369550B	Small Yellow Band Looped-End Mop	Jaw Style	00*	12 ea	8.00/0.68
369551B	Medium Green Band Looped-End Mop	Jaw Style	00*	12 ea	12.50/0.68
369552B	Large Red Band Looped-End Mop	Jaw Style	00*	12 ea	17.20/0.74
<b>4 Ply Cotton (Narrow Band)</b>					
369413B	Small Yellow Band Looped-End Mop	Quick Release/Quick Change	00*	12 ea	8.10/0.68
369419B	Medium Green Band Looped-End Mop	Quick Release/Quick Change	00*	12 ea	12.60/0.68
369425B	Large Red Band Looped-End Mop	Quick Release/Quick Change	00*	12 ea	17.80/0.74



### Microfiber Looped-End

- Microfiber mop combines the absorbency and durability of microfiber with conventional mop design and functionality
- Washable mop dries quickly and is still effective with 500 washings
- See pages 85 & 87 for a complete list of microfiber products

	1	2	3	4	5
Absorption	█	█	█	█	█
Durability	█	█	█	█	█
Release	█	█	█	█	█
Launderability	█	█	█	█	█



### Rough Surface Looped-End

- 17 oz knitted fleece provides twice the absorbency of cotton yarn mops
- Excellent for abrasive surfaces: stone, quarry, tile, and concrete

	1	2	3	4	5
Absorption	█	█	█	█	█
Durability	█	█	█	█	█
Release	█	█	█	█	█
Launderability	█	█	█	█	█



Handles sold separately; see pages 176-180 for handle recommendations



Prod No	Description	Handle	Color	Pack	Cs Wt/Cube
<b>Microfiber (Wide Band)</b>					
369420	Medium Loop End Microfiber Mop	Jaw Style	02, 14	12 ea	14.00/1.33
<b>Rough Surface (Narrow Band)</b>					
369320	Medium Looped-End Rough Surface Mop	Quick Release/Quick Change	00	12 ea	11.04/1.06



# MOPPING

## Rayon Blend Finishing Looped-End

- Durable 4-ply rayon blend has narrow band
- Releases liquid faster than a conventional mop for a smoother finish
- Brick packed

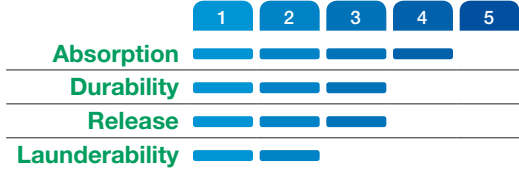

369674B



## 4 Ply Cotton Cut-End

- Economical choice for general mopping
- Brick packed

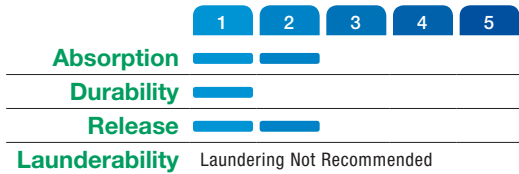

369817B



369824B

Handles sold separately; see pages 176-180 for handle recommendations



Prod No	Description	Handle	Color	Pack	Cs Wt/Cube
<b>4 Ply Rayon Blend Finishing (Wide Band)</b>					
369670B	#20 Medium Finishing Looped-End Mop	Quick Release/Quick Change	14	12 ea	14.00/0.68
369674B	#24 Large Finishing Looped-End Mop	Quick Release/Quick Change	14	12 ea	17.20/0.74
<b>4 Ply Cotton (Narrow Band)</b>					
369816B	#16 Small Cut-End Mop	Quick Release/Quick Change	00	12 ea	10.25/0.68
369820B	#20 Medium Cut-End Mop	Quick Release/Quick Change	00	12 ea	13.25/0.68
369824B	#24 Large Cut-End Mop	Quick Release/Quick Change	00	12 ea	16.25/0.68
369832	#32 X-Large Cut-End Mop	Quick Release/Quick Change	00	12 ea	20.52/1.66
<b>4 Ply Cotton (Wide Band)</b>					
369811B	#16 Small Cut-End Mop	Jaw Style	00	12 ea	9.50/0.68
369814B	#20 Medium Cut-End Mop	Jaw Style	00	12 ea	10.25/0.68
369817B	#24 Large Cut-End Mop	Jaw Style	00	12 ea	14.00/0.68
369819B	#32 X-Large Cut-End Mop	Jaw Style	00	12 ea	15.50/0.68



### 8 Ply Cotton Cut-End

- Abrasion-resistant, long lasting 8 ply cotton
- Best for general purpose cleaning

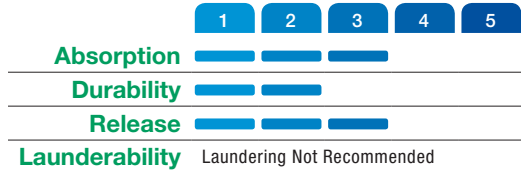

### 4 Ply Rayon Cut End

- Easy to change mop heads lie flat for more efficient mopping
- 40345 Kwik-On wood handle (sold separately) attaches securely to Kwik-On mop head with a counter-sunk, reinforced thread

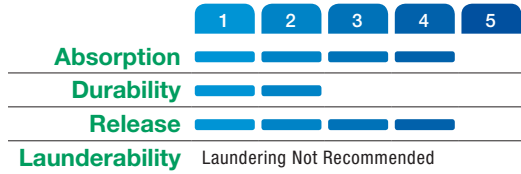

Handles sold separately; see pages 176-180 for handle recommendations

Standard(00)

Prod No	Description	Handle	Color	Pack	Cs Wt/Cube
<b>8-Ply Cotton (Narrow Band)</b>					
369724	#24 Select Cut-End Mop	Quick Release/Quick Change	00	12 ea	18.96/1.81
369732	#32 Select Cut-End Mop	Quick Release/Quick Change	00	12 ea	26.04/1.96
<b>4-Ply Rayon (Narrow Band)</b>					
369066B	#16 Small Cut-End Mop	Quick Release/Quick Change	00	12 ea	8.00/0.68
369070B	#20 Medium Cut-End Mop	Quick Release/Quick Change	00	12 ea	13.25/0.68
369074B	#24 Large Cut-End Mop	Quick Release/Quick Change	00	12 ea	16.45/0.74
369082	#32 X-Large Cut-End Mop	Quick Release/Quick Change	00	12 ea	20.52/1.58



# MOPPING

## Kwik-On™ Screw Top

- Easy to change mop heads lie flat for more efficient mopping
- 40345 Kwik-On wood handle (sold separately) attaches securely to Kwik-On mop head with a counter-sunk, reinforced thread

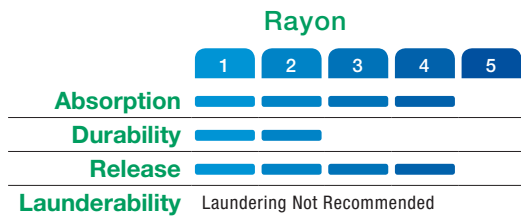
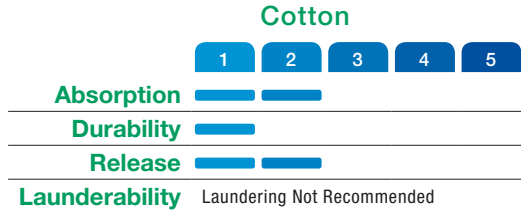

Handles sold separately; see pages 176-180 for handle recommendations

Standard(00)

Prod No	Description	Handle	Color	Pack	Cs Wt/Cube
<b>8-Ply Cotton (Narrow Band)</b>					
369724	#24 Select Cut-End Mop	Quick Release/Quick Change	00	12 ea	18.96/1.81
369732	#32 Select Cut-End Mop	Quick Release/Quick Change	00	12 ea	26.04/1.96
<b>4-Ply Cotton (Kwik-On Screw Top)</b>					
369024C	#24 Kwik-On Cotton Mop	Kwik-On	00	12 ea	18.96/1.50
<b>4-Ply Rayon (Kwik-On Screw Top)</b>					
369024R	#24 Kwik-On Rayon Mop Head	Kwik-On	00	12 ea	18.96/1.26
<b>Kwik-On Handle</b>					
40345	60" Kwik-On Handle 1-1/8" Diameter	—	00	12 ea	16.70/0.54





### Automatic Sponge Mop

- Recommended for mopping smooth surfaces
- Synthetic sponge head absorbs liquid fast

### Ty-Dee™ Sponge Mop

- Recommended for mopping smooth surfaces
- Cellulose sponge head with non-corrosive metal parts and enameled wood handle

### Wax Applicator

- Synthetic woven pile perfect for applying waxes, sealers and finishes
- Handle sold separately; see pages 176-180 for handle recommendations



Standard(00)

Prod No	Description	Color	Pack	Cs Wt/Cube
<b>Automatic Sponge Mops – Aluminum Handle</b>				
40300	8-1/2" Automatic Sponge Mop	00	12 ea	23.80/5.78
40301	12" Automatic Sponge Mop	00	6 ea	13.85/7.23
40305	8-1/2" Automatic Sponge Mop Refill	00	12 ea	3.85/0.44
40306	12" Automatic Sponge Mop Refill	00	6 ea	2.75/2.21
<b>Ty-Dee Sponge Mop – Enamel Wood Handle</b>				
36990	8-1/4" Ty-Dee Sponge Mop with Built-in Wringer	00	12 ea	18.96/4.04
36990R	8-1/4" Ty-Dee Refill	00	12 ea	3.96/0.35
<b>Wax Applicator</b>				
361600	16" Applicator	00	12 ea	16.00/0.68
361603	16" Applicator Refill	00	24 ea	4.00/0.92



# MOPPING

## Bucket & Wringer Combos

- Made of durable, corrosion resistant polyethylene
- Non-marking casters
- Available in 26 or 35 quart sizes
- Individual Side Press Wringer available – fits both 26 quart (36908) and 35 quart (36904) mop buckets

**LASTS  
65,000  
CYCLES**  
30% longer\* than the competition!



Prod No	Description	Color	Pack	Cs Wt/Cube
<b>Mop Buckets</b>				
36908	26 qt Bucket with Side Press Wringer	04, 05, 09, 14, 69	1 ea	15.40/3.01
36904	35 qt Bucket with Side Press Wringer	04, 05, 09, 14, 69	1 ea	19.10/3.15
36908W	Side Press Wringer for 26 qt and 35 qt Mop Bucket	04, 05, 09, 14, 69	1 ea	8.00/1.62
36905	35 qt Bucket with Down Press Wringer	04	1 ea	22.20/3.32
36908C	3" Swivel Casters for all Mop Buckets	00	2 ea	8.00/2.88

\*Based on internal testing of Carlisle's Down Press Wringer



## Wet Floor Signs

- Durable polypropylene
- Specially designed feet minimize contact with floor to protect floor finishes
- 36900 locks into place to prevent collapsing
- Compact for easy storage



## Freestanding Caution Cones and Accessories

- 360° visibility
- Caution message appears in English, Spanish and French



The Flashing Hazard Light (36949) and Caution Top Card (36947) can be inserted in Caution Cones (36940, 36941) for increased visibility.



## Caution Pop Up Cones

- 360° visibility
- Caution message appears in English, Spanish and French
- Case can be mounted to wall for easy access



Case for 36942 Pop Up Caution Cone

## Caution Barrier

- Two-sided barrier
- Caution message appears in English, Spanish and French



Prod No	Description	Color	Pack	Cs Wt/Cube
<b>Folding Wet Floor Signs</b>				
36900*	Floor Sign (English/Spanish)	00	6 ea	11.25/1.88
36909	Economy Wet Floor Sign (English/Spanish/German)	04	6 ea	12.60/1.45
<b>Caution Cones &amp; Barriers</b>				
36940	27" Caution Cone	04	3 ea	22.00/3.70
36941	36" Caution Cone	04	3 ea	22.00/4.75
36942	20" Pop Up Caution Cone	04	12 ea	57.00/2.18
36949	Caution Cone Flashing Hazard	04	12 ea	7.37/1.30
36947	Caution Cone Top Card	04	12 ea	11.00/1.59
36944	Three Panel Caution Barrier	04	1 ea	9.47/2.53
36945	One Panel Caution Barrier Add On	04	1 ea	4.62/2.53

\*Listed under US Patent No. 7013590B1

# HANDLE MATERIALS

*All handles serve an important purpose for every cleaning job.*

**Carlisle provides many different handle materials** to meet your specific need and application.

	Fiberglass	Plastic	Wood
<b>Durability</b>	Medium*	Medium*	Medium*
<b>Corrosion Resistance</b>	N/A	N/A	N/A
<b>Weight</b>	Medium	Medium	Low
<b>Chemical Resistance</b>	High	Polypropylene – High PVC – Medium	Medium
<b>Flexibility</b>	Low	High	Medium*

\* Wall thickness or handle diameter may vary and affect durability or flexibility

Fiberglass



Plastic



Wood



	Aluminum	Stainless Steel	Steel
<b>Durability</b>	Low	High	Medium*
<b>Corrosion Resistance</b>	Medium	High	Low
<b>Weight</b>	Low	High*	Medium
<b>Chemical Resistance</b>	Medium	High	Low
<b>Flexibility</b>	High*	Low	Medium

\* Wall thickness or handle diameter may vary and affect durability or flexibility

Aluminum



Stainless Steel



Steel





# HANDLES

## Quick-Release Mop Handles

- Only Carlisle offers a unique locking mechanism that prevents mop being dislodged or falling off
- Color coded for compliance with HAACP regulations
- 60" durable fiberglass
- Flexible plastic head with hinged gripper bites into any size mop band
- Releases mop head quickly for labor savings; employees never need to touch a dirty mop head



### For Narrow Band Mops



## Quick Change Handles

- Economical choice
- Use with narrow band mops
- Plastic head with thumb wheel clamps mop in place
- Metal heads feature standard wing nut construction with a quick release cross bar

### For Narrow Band Mops

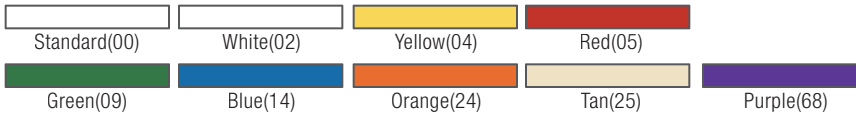

Prod No	Description	Handle Dia	Color	Pack	Cs Wt/Cube
<b>Color-Coded Quik-Release Mop Handle</b>					
41664	60" Fiberglass Mop Handle	1"	02, 04, 05, 09, 14, 24, 25, 68	12 ea	15.75/2.78
<b>Quik-Release Handle</b>					
369595	Quik-Release Powder-Coated Metal Handle	—	00	12 ea	17.60/2.68
<b>Quick Change Handles – Wood</b>					
369365	60" Wood Mop Handle with Plastic Head	1-1/8"	00	12 ea	22.50/3.46
40340	63" Wood Mop Handle with Metal Head	1-1/8"	00	12 ea	30.00/2.00
<b>Quick Change Handle – Fiberglass</b>					
369375	60" Fiberglass Mop Handle with Plastic Head	1"	00	12 ea	16.25/3.46
<b>Quick Change Handle – Vinyl Coated Metal</b>					
36968	60" Handle with Plastic Head	1"	00	12 ea	15.36/2.27



## Jaw Style Mop Handles

- Jaw clamp attachment prevents handle to floor contact avoiding scratching and other damage
- Color coded for compliance with HAACP regulations
- Releases mop head without employee touching dirty mop head
- Clamp teeth for secure hold and more efficient cleaning



For Wide Band Mops



369475 – Color coded for HAACP compliance

36970

## Kwik-On™ Screw Top

- Most secure mop head fit
- Easy to change mop heads lie flat for more efficient mopping
- 40345 Kwik-On wood handle attaches securely to Kwik-On mop head (sold separately) with a counter-sunk, reinforced thread



For Kwik-On Mop



40345



362013 – High durability



45850 – Economy wood



364105 – Easy attachment

## Dust Mop Handles

- Available in wood, coated metal and fiberglass
- 360° movement for fast and easy cleaning
- 364105 features a flexible connector
- 362113 fiberglass color coded for compliance with HAACP regulations

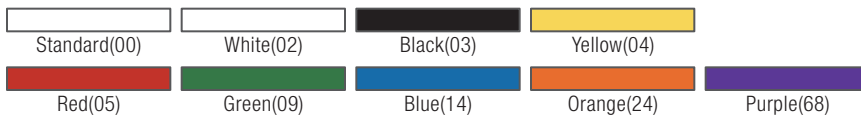

Prod No	Description	Handle Dia	Color	Pack	Cs Wt/Cube
<b>Jaw Style Mop Handles</b>					
369475	60" Fiberglass Mop Handle	1"	00, 02, 03, 04, 05, 09, 24, 68	12 ea	25.00/3.46
36970	60" Vinyl Coated Metal Mop Handle	15/16"	00	12 ea	13.92/2.27
<b>Kwik-On Handle</b>					
40345	60" Kwik-On Handle 1-1/8" Diameter	—	00	12 ea	16.70/0.54
<b>Dust Mop Handles</b>					
364105	60" Vinyl Coated Metal Dust Mop Handle with Flexible Connector	15/16"	00	12 ea	15.00/2.10
45850	60" Wood Dust Mop Handle with Clip-On Connector	15/16"	00	12 ea	20.00/1.63
362013	60" Vinyl Coated Metal Dust Mop Handle with Clip-On Connector	15/16"	00	12 ea	20.10/2.54
<b>Fiberglass Dust Mop Handles</b>					
362113	60" Fiberglass Dust Mop Handle	1"	02, 03, 04, 05, 09, 14, 24, 68	12 ea	25.00/3.46



# HANDLES

Carlisle offers a **large selection of professional quality handles** that include fiberglass, plastic, metal, hardwood and telescoping.

## Wood Handles

- All-purpose handles
- Made of lacquered hardwood
- Available in a large selection of standard threaded and tapered styles, along with our Anchor™ Style
- Economical choice

**Learn more about the Flex-All handle on page 106**



Standard(00)

Prod No	Description	Handle Dia	Handle Style	Color	Pack	Cs Wt/Cube
<b>Wood Threaded Handles</b>						
3620104	48" Wood Handle	7/8"	Threaded	00	12 ea	9.96/0.44
40271	60" Wood Handle	15/16"	Threaded	00	12 ea	13.36/0.49
40267	60" Wood Handle	1-1/8"	Threaded	00	12 ea	16.00/0.62
3620016	72" Wood Handle	15/16"	Threaded	00	12 ea	14.04/0.88
<b>Flex-All Adapter Handle</b>						
40281	54" Wood Handle with 4" Flex-All Adapter	15/16"	Threaded	00	6 ea	7.00/0.43
<b>Nylon Threaded Handle</b>						
40285	60" Nylon Thread Tip Wood Handle	15/16"	Nylon Thread	00	12 ea	13.00/0.52
<b>Anchor Style Handle</b>						
45270	60" Anchor Style Wood Handle	1-1/8"	Anchor	00	12 ea	22.50/0.84
<b>Tapered Handles</b>						
40261	54" Wood Handle	1-1/8"	Tapered	00	12 ea	15.00/0.59
3620125	60" Wood Handle	15/16"	Tapered	00	12 ea	11.04/0.56
40262	60" Wood Handle	1-1/8"	Tapered	00	12 ea	16.80/0.66
<b>Juno Style Handle</b>						
3620405	60" Juno Style Wood Handle	1-1/8"	Juno	00	12 ea	18.00/0.70
<b>Metal Threaded Handles</b>						
40275	40" Metal Threaded Wood Handle	7/8"	Metal Thread	00	12 ea	9.65/0.40
45267	60" Metal Threaded Wood Handle	15/16"	Metal Thread	00	12 ea	13.75/0.49
3620055	60" Metal Threaded Wood Handle	1-1/8"	Metal Thread	00	12 ea	16.92/0.42
45268	72" Metal Threaded Wood Handle	15/16"	Metal Thread	00	12 ea	17.00/0.58
3620058	96" Metal Threaded Wood Handle	1-1/8"	Metal Thread	00	12 ea	27.96/1.39





41291 – Flex Tip, available in 36"

41225 – Flex Tip, available in 36"

40225 – Flex Tip, available in 60"

41226 – Flex Tip, available in 72"

40220 – Compatible with tapered or threaded

40210 – Fits locking collar tools

40227 – Foam filled, most durable

41020 – Adjusts up to 8' long

## Color-Coded Fiberglass Handles

- Durable for heavy usage
- For use with push brooms, sweeps, squeegees and floor scrubs
- Fiberglass handles are available in threaded, tapered/threaded and telescoping
- Self-Locking Flex-Tip Handle offers greater flexibility and reduces handle stress
- Available in up to 10 different colors to ensure HAACP compliance

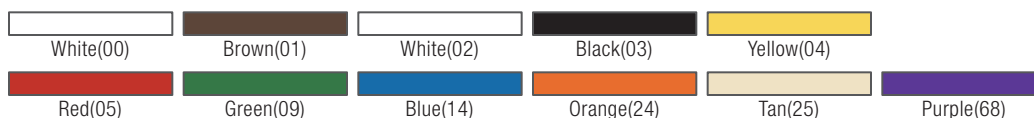

Prod No	Description	Handle Dia	Handle Style	Color	Pack	Cs Wt/Cube
<b>Fiberglass Handles</b>						
41225	48" Fiberglass Handle with Self-Locking Flex-Tip	1"	Threaded	00, 01, 04, 05, 09, 14, 25	12 ea	10.50/0.64
41291	36" Fiberglass Handle with Self-Locking Flex-Tip	1"	Threaded	00	12 ea	8.50/0.48
40225	60" Fiberglass Handle with Self-Locking Flex-Tip	1"	Threaded	01, 02, 03, 04, 05, 09, 14, 24, 25, 68	12 ea	13.00/0.80
40227	60" Solid Foam Filled Fiberglass Handle with Self-Locking Flex-Tip	1"	Tapered/Threaded	02, 04, 05, 09, 14	12 ea	16.00/0.80
40220	60" Fiberglass Handle	1"	Tapered/Threaded	01, 02, 04, 05, 09, 14	12 ea	12.00/2.14
40210	60" Economy Fiberglass Handle	15/16"	Threaded	01, 02, 04, 05, 09, 14	12 ea	10.26/0.89
41226	72" Fiberglass Handle with Self-Locking Flex-Tip	1"	Threaded	00	12 ea	15.65/0.96
362113	60" Fiberglass Dust Mop Handle	1"	—	02, 03, 04, 05, 09, 14, 24, 68	12 ea	25.00/3.46
41020	54" to 8' Threaded Telescoping Fiberglass Handle	1"	Threaded	01, 02, 04, 05, 09, 14, 25	12 ea	28.00/1.00



# HANDLES

## Steel Handles

- Heavy-duty stainless steel handles are highly chemical resistant
- For use with caustic chemicals or in a sanitary food processing environment
- Highly durable alternative to fiberglass

## Coated Metal Handles

- Lightweight and economical
- Plastic hanging cap

## Flo-Thru Handle

- Use with most window, wall and vehicle Flo-Thru brushes
- Features an on/off valve to control water flow

## 3-Piece Aluminum Handle

- Utilizes metal y-connectors to secure sections
- Easily broken down for easy storage and transport for on demand use
- Compact size saves on shipping costs
- Shelf-ready packaging
- Universal thread



41199



45259



40223 – Wood grain; environmental choice



3620275 – Extremely tight fit



3620194 – Compatible with DuoSweep brooms



3620294 - Compatible with DuoSweep brooms



40241 – Compatible with most flo-thru brushes



40224



Prod No	Description	Handle Dia	Handle Style	Color	Pack	Cs Wt/ Cube
<b>Steel Handles</b>						
41199	60" Stainless Steel Handle	1"	Threaded	00	12 ea	24.00/0.91
45259	60" Steel Handle	15/16"	Threaded	00	12 ea	14.70/0.69
<b>Coated Metal Handles</b>						
3620275	60" Heavy-Duty Plastic Coated Metal Handle with Metal Tip	15/16"	Threaded	03	12 ea	30.00/0.45
40223	60" Wood Grain Plastic Coated Metal Handle with Metal Tip	15/16"	Threaded	00	12 ea	13.50/0.56
3620194	48" Light-Weight Powder Coated Metal Handle with Plastic Tip	7/8"	Threaded	14	12 ea	7.85/0.71
3620294	48" Plastic Coated Metal Handle with Plastic Tip	15/16"	Threaded	03	12 ea	8.00/0.46
<b>Flo-Thru Handle</b>						
40241	60" Fiberglass Flo-Thru Handle with NPT Thread and Shut-Off Valve	7/8"	Threaded	04	12 ea	15.00/0.80
<b>3-Piece Aluminum Handle</b>						
40224	60" 3-Piece Aluminum Handle with Standard Thread	1"	Threaded	00	12 ea	13.00/0.80



365408



40251



41020



40233 – Available in 36" and 48"



40232 – Available in 54" and 60"



41232 – Tapered

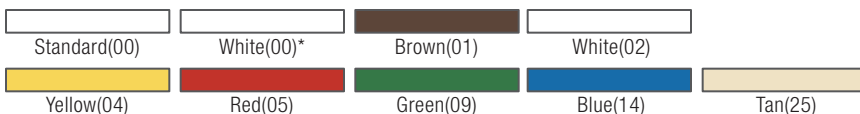

## Telescopic Handles

- Adjusts quickly to desired length
- Standard threaded end
- Ideal for window brushes and squeegees

## Aluminum with Locking Joints

- Ribbed aluminum for grip
- Tapered threaded tip for compatibility with all window squeegees
- Twist locking joints for securing desired length

## Aluminum Handle

- Smooth finish
- Three section adjustability for more specific length needs

## Threaded Fiberglass Handle

- Color coded options for compliance with HAACP regulations
- High durability fiberglass

## Plastic Handles

- A variety of sizes with reinforced threaded tip
- For light usage
- For foodservice and sanitary applications when fiberglass is not compatible

Prod No	Description	Handle Dia	Handle Style	Color	Pack	Cs Wt/Cube
<b>Telescopic Handles</b>						
365408	54" to 8' Aluminum Telescopic Handle with Locking Joints	1"	European Tapered/Standard Threaded	00	10 ea	11.90/0.48
365414	67" to 14' Aluminum Telescopic Handle with Locking Joints	1"	European Tapered/Standard Threaded	00	10 ea	30.00/1.42
365420	87" to 20' Aluminum Telescopic Handle with Locking Joints	1"	European Tapered/Standard Threaded	00	10 ea	40.00/1.62
40251	41" to 8' Aluminum Telescopic Handle	3/4"	Threaded	00	6 ea	9.00/0.25
40250	57" to 12' Aluminum Telescopic Handle	1"	Threaded	00	6 ea	12.00/0.44
41014	79" to 18' Aluminum Telescopic Handle	1"	Threaded	00	6 ea	16.25/0.89
36424T	83" to 24' Aluminum Telescopic Handle	1"	Threaded	00	6 ea	22.02/1.16
41020	54" to 8' Threaded Telescoping Fiberglass Handle	1"	Threaded	01, 02, 04, 05, 09, 14, 25	12 ea	28.00/1.00
<b>Plastic Handles</b>						
40230	36" Plastic Handle with Reinforced Tip	1"	Threaded	00*	12 ea	17.70/0.55
40233	48" Plastic Handle with Reinforced Tip	1"	Threaded	00*	12 ea	22.00/0.76
41165	54" Plastic Handle with Reinforced Tip	1"	Threaded	00*	12 ea	23.00/0.79
40232	60" Plastic Handle with Reinforced Tip	1"	Threaded	00*	12 ea	27.00/0.91
41232	60" Plastic Handle	1"	Tapered	00*	12 ea	27.25/0.91



# HANDLES

## Flex-All™ Adapter Handle

- Provides a flexible link to prevent tip breakage, deforming, or whipping of handle if broom comes into contact with immobile objects
- Reduces the chance of personal injury or equipment and door facing damage
- Prevents broom handle tip from breaking off in broom head

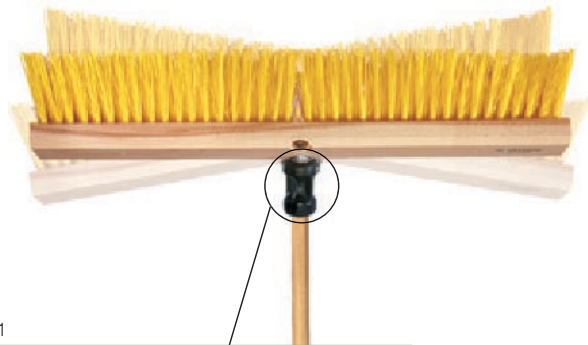

40281



## Braces & Adapters

- Prevents broken handles even when sweeping large accumulations
- Rust-resistant; includes necessary hardware and instructions
- Use with 24" and 36" push brooms

### 45280

- Compatible with broom lengths 24" and higher
- Most heavy duty brace connection to prevent handle breaking

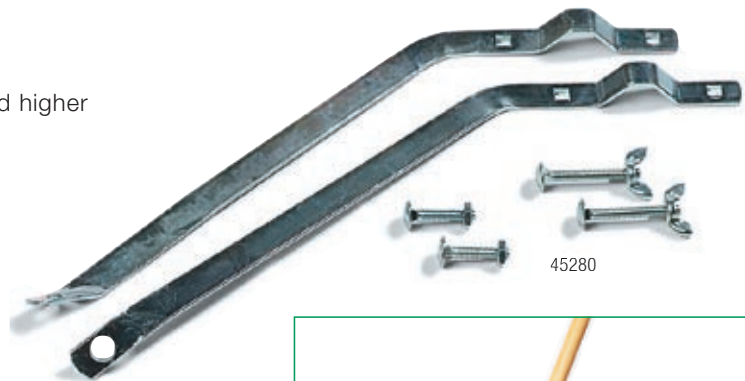

45280

### 365150

- Compatible with all handle styles



365150



Standard(00)

Prod No	Description	Handle Dia	Handle Style	Color	Pack	Cs Wt/Cube
<b>Flex-All Adapter Handle</b>						
40281	54" Wood Handle with 4" Flex-All Adapter	15/16"	Threaded	00	6 ea	7.00/0.43
<b>Braces &amp; Adapters</b>						
45280	Large Metal Handle Brace	—	—	00	12 ea	6.00/0.49
365150	Small Metal Block Handle Brace	—	—	00	24 ea	6.50/0.17
45282	Aluminum Replacement Thread	15/16"	—	00	12 ea	2.00/0.05



## Roll 'N Grip™ Broom & Brush Holder System

- Adjustable rack holds a variety of different handle diameters
- Comes with a convenient hook for tools and brushes (additional hooks and grippers are available by special order)
- Rack anchor holes are 16" on center (mounting screws included)



TOP SELLER



40737

## Roll 'N Grip Plus

- Constructed of light-weight, durable ABS and rubber
- Fold-up hanging hooks for smaller items
- For use in temperatures from -4°F to 176°F
- Grips accommodate items from 5/8" - 1-1/4" in diameter and 0.4 - 8-1/4 lbs
- Hanging hooks can hold up to 1-1/2 lbs each



## Color-Coded Brush Rack

- Heavy-gauge aluminum
- Extra deep (2-1/4") frame extends out from wall to allow brushes to hang with bristles facing the wall
- Holds up to 10 hanging tools
- Mounting holes are 16" on center (mounting screws included)
- Available in 5 colors to support HACCP compliance

40735



Prod No	Description	Color	Pack	Cs Wt/Cube
<b>Roll 'N Grip Broom &amp; Brush Holder System</b>				
40731	18" Roll 'N Grip Broom & Brush Holder System	00	12 ea	9.00/1.06
40732	Roll 'N Grip Replacement Roller (2 per pack) with 4 Wood Screws	00	12 pk	3.35/0.30
40733	Roll 'N Grip Replacement Hooks (2 per pack) with 4 Wood Screws	00	12 pk	0.50/0.16
<b>Roll 'N Grip Plus</b>				
40737	16-1/2" Roll 'N Grip Plus Broom & Brush Holder	00	24 ea	35.00/2.68
<b>Color-Coded Brush Rack</b>				
40735	17" Brush Rack	00*, 04, 05, 09, 14	12 ea	3.50/0.77

# ***EZSnap***

SAVE MONEY & BE ECO-FRIENDLY



# THE **TOTAL** FLOOR CARE SYSTEM

## Value Rotary Brushes & EZ Snap Clutch Plates

Carlisle knows that proper floor cleaning and maintenance requires the right equipment and supplies. **We couple our value rotary brushes and EZ Snap clutch plates to create a simple solution for floor maintenance.** Combine all of their features and what you get is real, measurable cost savings along with “peace of mind” knowing you are doing what is right for the environment.

When compared to floor pads, Value Rotary Brushes are:

- **MORE COST EFFECTIVE** – outlasts floor pads 100 to 1
- **MORE EFFICIENT** – less change outs of brushes lowers your labor cost
- **MORE SUSTAINABLE** – long lasting brushes reduce packaging, storage and landfill waste

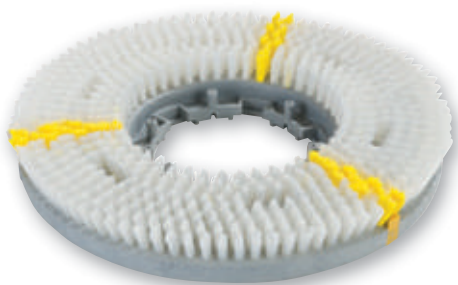

### Daily Cleaning Brush

#### *Replaces White Floor Pads*

- Specifically designed for daily cleaning and maintaining of all high gloss floor surfaces
- Ideal for use on ceramic tile, concrete, marble, quarry tile, slate, terrazzo and VCT

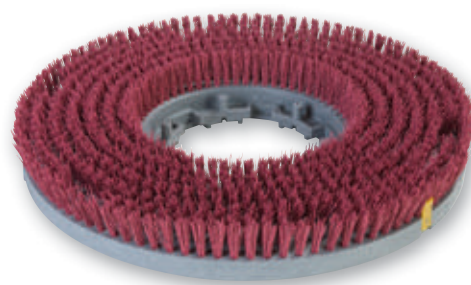

### Red Cleaning Brush

#### *Replaces Red Floor Pads*

- For medium to mildly aggressive cleaning of ceramic tile, concrete, marble, non-slip flooring, quarry tile, rubber, slate, terrazzo and VCT
- .022" nylon fibers impregnated with 320 grit silicon carbide



### Scrubbing/Stripping Brush

#### *Replaces Black Floor Pads*

- Excellent for scrubbing concrete and stripping quarry tile, terrazzo and VCT
- .050" nylon fibers impregnated with 80 grit silicon carbide

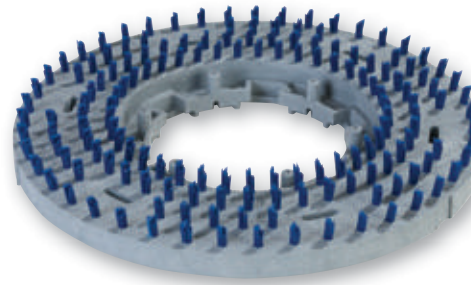

### Short Trim Pad Driver

- 1/2" long, polypropylene bristles unevenly trimmed and widely spaced for excellent holding power

To see how you can save even more money visit [www.carlislefsp.com/ez](http://www.carlislefsp.com/ez)



# EZ SNAP FLOOR CARE SYSTEM

Carlisle has combined our value rotary brushes and EZ Snap clutch plates to create a **simple, cost-efficient solution for floor maintenance.**

## Value Rotary Brushes

- Long lasting brushes reduce packaging, storage and landfill waste
- Wear Indicator on side of block takes the guesswork out of when to change out brush
- Available in three popular bristle “strengths” for all hard floor maintenance applications
- Irregular bristle length for optimal cleaning on uneven surfaces

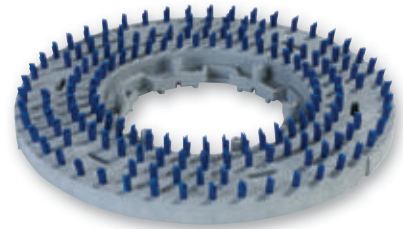
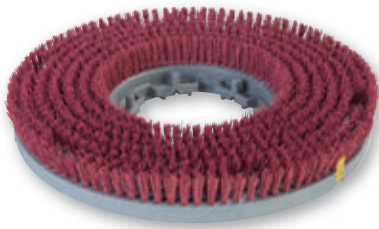
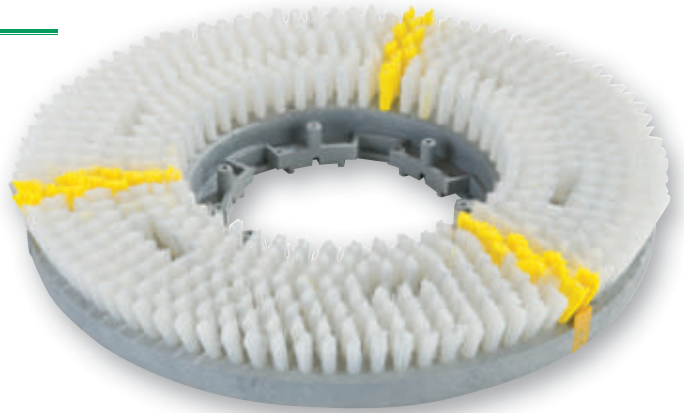

Prod No	Description	Pack	Cs Wt/Cube
<b>Value Rotary Brushes</b>			
<b>White</b>	<b>Red</b>	<b>Black</b>	
3611VWH	3611VRD	3611VBK	11" Value Rotary Brush
3612VWH	3612VRD	3612VBK	12" Value Rotary Brush
3613VWH	3613VRD	3613VBK	13" Value Rotary Brush
3614VWH	3614VRD	3614VBK	14" Value Rotary Brush
3615VWH	3615VRD	3615VBK	15" Value Rotary Brush
3616VWH	3616VRD	3616VBK	16" Value Rotary Brush
3617VWH	3617VRD	3617VBK	17" Value Rotary Brush
3618VWH	3618VRD	3618VBK	18" Value Rotary Brush
3619VWH	3619VRD	3619VBK	19" Value Rotary Brush
3620VWH	3620VRD	3620VBK	20" Value Rotary Brush

Prod No	Description	Pack	Cs Wt/Cube
<b>Short Trim Pad Driver</b>			
3611PD	11" Short Trim Pad Driver	1 ea	2.50/0.25
3612PD	12" Short Trim Pad Driver	1 ea	3.75/0.37
3613PD	13" Short Trim Pad Driver	1 ea	3.75/0.37
3614PD	14" Short Trim Pad Driver	1 ea	3.94/0.45
3615PD	15" Short Trim Pad Driver	1 ea	4.00/0.51
3616PD	16" Short Trim Pad Driver	1 ea	5.20/0.68
3617PD	17" Short Trim Pad Driver	1 ea	5.75/0.72
3618PD	18" Short Trim Pad Driver	1 ea	6.10/0.68
3619PD	19" Short Trim Pad Driver	1 ea	7.00/0.87
3620PD	20" Short Trim Pad Driver	1 ea	7.70/0.87





## EZ Snap Clutch Plates

- Patent pending design provides durability and ease of use
- Simple, snap in installation
- Variety of styles to fit popular machines models



364192BD



364108BD



364192REZ



364112BD



36P74BD



364200BD



364148BD



364200REZ

### No Tools Required for Installation

Snap On



Snap Off



Go to the EZ Snap landing page at [www.carlislefsp.com/ez](http://www.carlislefsp.com/ez). Here you can find all the EZSnap tools you need.

Prod No	Description	Pack	Cs Wt/Cube
<b>EZ Snap Clutch Plates</b>			
364192BD	Universal Style Clutch Plate	6 ea	2.75/0.41
364108BD	Clip On Style Brush Driver	6 ea	5.25/0.56
36P74BD	Lug Style Brush Driver	6 ea	4.40/1.07
364112BD	Win Snap Brush Driver	6 ea	4.26/0.79
364148BD	Tri Snap Brush Driver	6 ea	3.13/0.37
<b>EZ Snap Adapter Plate</b>			
364200BD	Adapter Plate	6 ea	2.76/0.37
<b>EZ Risers</b>			
364192REZ	Universal Style Combo Brush Driver	6 ea	6.24/0.79
364200REZ	Adapter Combo Brush Driver	6 ea	6.28/0.79

# ROTARY BRUSHES | COLORTECH

Only Colortech Rotary Brushes Outlast  
Floor Pads More Than 200 To 1\*



FLOOR CARE PRODUCTS



Rotary Brushes are the simple floor care solution. They clean more effectively, using nylon filament impregnated with Silicon Carbide grit. And, we offer a wide selection of rotary brushes to match all of your floor care needs including stripping, scrubbing and general cleaning of high traffic areas in office buildings, malls, schools, hospitals, and stores.

\* Based on an independent 2009 University of Illinois Colortech Rotary Brush Study – Durability/Sustainability

## Advantages Over Pads:

- Rotary brushes outlast floor pads more than 200 to 1, ultimately saving time and money
- Reduces packaging, storage and waste
- Lowers labor cost by reducing change out frequency and time
- Eliminates pad tearing and the need to re-center pads
- All rotary brushes utilize durable plastic blocks specially constructed to provide long lasting, superior performance
- Brushes perform well on all types of surfaces including new or old floors with uneven surfaces
- Solution feed design allows cleaning solution to flow through rotary brush block for thorough cleaning



## Showerfeed Rotary Block

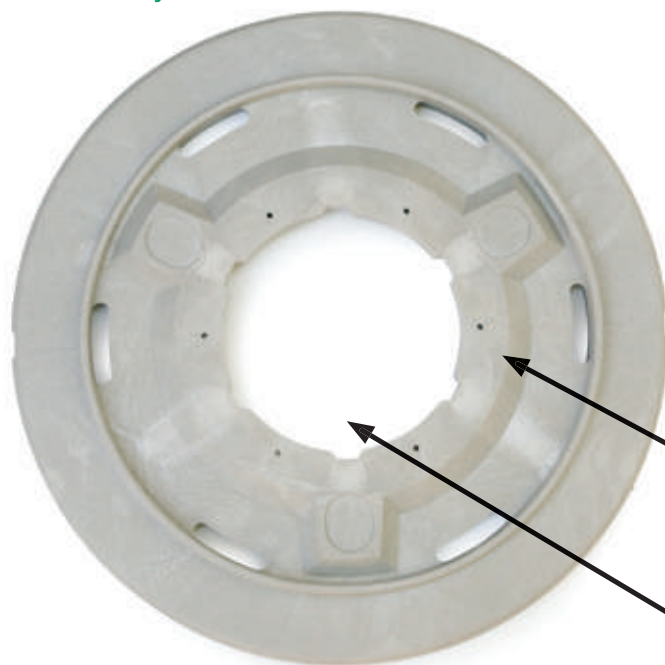

### Solution Feed Holes

Redesigned for better usage and a more even coverage. This improvement alone proves to be 10 times more effective at directing solution for utilization.

### Interlocking Design

Increases the durability of the riser and the block.



### Riser Installation

Interlocking Riser comes with stainless steel fasteners for securing the connection to the rotary brush block.



### Wear Indicator

The wear indicator tab is a non-marking visual indicator for when it is time to replace the rotary brush.

## Online Tools

Check out our two online tools which aid in the transition from pads to brushes.



[www.carlislefsp.com/colortech\\_calc](http://www.carlislefsp.com/colortech_calc)



[www.carlislefsp.com/rotarywizard](http://www.carlislefsp.com/rotarywizard)

# ROTARY BRUSHES | COLOR TECH



## Daily Cleaning For all High Gloss Floor Surfaces

- Specifically designed for daily cleaning of all High Gloss floor surfaces while still maintaining floor shine
- For daily cleaning of ceramic tile, concrete, marble, quarry tile, slate, terrazzo and VCT
- Irregular bristle length to assure cleaning on uneven surfaces
- Available in 11" – 20" diameter showerfeed blocks
- Great for grout lines less than 1/2" in width

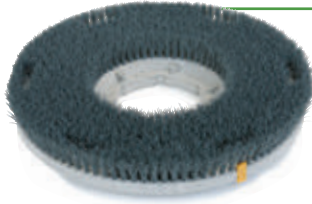

## Light Cleaning Replaces Light Green Pad

- For light to medium cleaning of ceramic tile, concrete, marble, quarry tile, rubber floors, slate, terrazzo and VCT
- .018" nylon fibers impregnated with 500 grit silicon carbide
- Available in 11" – 20" diameter showerfeed blocks with 1-1/2" trim
- Great for grout lines less than 1/2" in width



## Cleaning Replaces Red Pads

- For medium to mildly aggressive cleaning of ceramic tile, concrete, marble, non-slip flooring, quarry tile, rubber, slate, terrazzo and VCT
- .022" nylon fibers impregnated with 320 grit silicon carbide
- Available in 11" – 20" diameter showerfeed blocks with 1-1/2" trim
- Great for grout lines less than 1/2" in width



## Scrubbing Replaces Blue Pads

- For aggressive top scrubbing of ceramic tile, rubber, terrazzo and VCT
- .035" nylon fibers impregnated with 180 grit silicon carbide
- Available in 11" – 19" diameter showerfeed blocks with 1-1/2" trim
- Great for grout lines less than 1/2" in width



## Stripping Replaces Black Pads

- Excellent for scrubbing of concrete and stripping of quarry tile, terrazzo and VCT
- .050" nylon fibers impregnated with 80 grit silicon carbide
- Available in 11" – 20" diameter showerfeed blocks with 1-1/2" trim
- Great for grout lines 1/2" or greater in width



## Aggressive Stripping Replaces High Productivity Pads

- Aggressive scrubbing of concrete and aggressive stripping of terrazzo and VCT
- .060" nylon fibers impregnated with 46 grit silicon carbide
- Available in 11" – 20" diameter showerfeed blocks with 1-1/2" trim
- Great for grout lines 1/2" or greater in width



## Concrete Floor Care

- Our most aggressive brush for scrubbing heavy soil from concrete in industrial applications
- .070" nylon fibers impregnated with 36 grit silicon carbide
- Available in 11" – 20" diameter showerfeed blocks with 1-1/2" trim



**Daily Cleaning Brush**

*High Gloss Surfaces*

Replaces Lt. Green & Red Pads

Block Dia	Prod No
11"	361100HG
12"	361200HG
13"	361300HG
14"	361400HG
15"	361500HG
16"	361600HG
17"	361700HG
18"	361800HG
19"	361900HG
20"	362000HG

**Green Brush**

*Light Cleaning*

Replaces Light Green Pads

Block Dia	Prod No
11"	361100G18-5N
12"	361200G18-5N
13"	361300G18-5N
14"	361400G18-5N
15"	361500G18-5N
16"	361600G18-5N
17"	361700G18-5N
18"	361800G18-5N
19"	361900G18-5N
20"	362000G18-5N

**Red Brush**

*General Cleaning*

Replaces Red Pads

Block Dia	Prod No
11"	361100G22-5N
12"	361200G22-5N
13"	361300G22-5N
14"	361400G22-5N
15"	361500G22-5N
16"	361600G22-5N
17"	361700G22-5N
18"	361800G22-5N
19"	361900G22-5N
20"	362000G22-5N

**Blue Brush**

*Scrubbing*

Replaces Blue Pads

Block Dia	Prod No
11"	361100G35-5N
12"	361200G35-5N
13"	361300G35-5N
14"	361400G35-5N
15"	361500G35-5N
16"	361600G35-5N
17"	361700G35-5N
18"	361800G35-5N
19"	361900G35-5N
20"	N/A

**Black Brush**

*Stripping*

Replaces Black Pads

Block Dia	Prod No
11"	361100G50-5N
12"	361200G50-5N
13"	361300G50-5N
14"	361400G50-5N
15"	361500G50-5N
16"	361600G50-5N
17"	361700G50-5N
18"	361800G50-5N
19"	361900G50-5N
20"	362000G50-5N

**Purple Brush**

*Aggressive Stripping*

Replaces High Productivity Pads

Block Dia	Prod No
11"	361100G60-5N
12"	361200G60-5N
13"	361300G60-5N
14"	361400G60-5N
15"	361500G60-5N
16"	361600G60-5N
17"	361700G60-5N
18"	361800G60-5N
19"	361900G60-5N
20"	362000G60-5N

**Brown Brush**

*Concrete Floor Care*

Block Dia	Prod No
11"	361100G70-5N
12"	361200G70-5N
13"	361300G70-5N
14"	361400G70-5N
15"	361500G70-5N
16"	361600G70-5N
17"	361700G70-5N
18"	361800G70-5N
19"	361900G70-5N
20"	362000G70-5N



# ROTARY BRUSHES | GUIDE

1. Find the make and model number of your floor machine on pages 132-145 to determine the correct brush block size and clutch plate. Additional clutch plate information can be found on pages 130-131. See A1 & A2 as referred.

- Brushes and long fill pad drivers for single brush, swing machines are usually 2" smaller than the machine size. For example: a 20" machine uses an 18" block.
- Short trim pad drivers are usually 1" smaller than the machine size. Add 1" to the block size in this table for these drivers.
- Special sizes, or brushes without available plates may require a preparation charge. These are noted by instructions to CALL Customer Service for information and prices.

2. Find the brush type for your cleaning application in the Brush Selection Guide on pages 118-121. See figures B1 & B2 as referred.

3. The Rotary Wizard can also determine the item number by machine, make and model number, brush type and/or brush number. Visit [www.carlislefsp.com/rotarywizard](http://www.carlislefsp.com/rotarywizard).

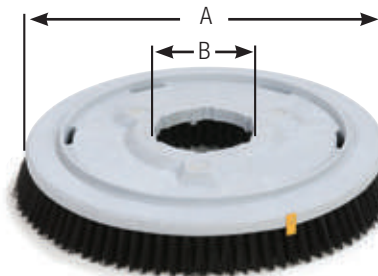

Figure A3

Flo-Pac® recommends the popular "P" Series Plastic Universal Clutch Plate. Alternate Universal Metal Plates are described on page 130.

When ordered with a brush, clutch plates are mounted with no installation fee.

If ordering a brush without a clutch plate, or if no plate is available for your model, specify machine model, block diameter (dimension A), and center hole diameter (dimension B). See Figure A3 above.

## A1 Nilfisk-Advance (Advance)

Model No	Block Dia	Sugg Plate
All Purpose Matador 17	15"	364147P
All Purpose Matador 20	18"	364147P
BA 5321, BA 5321D	20"	364148P
Converta Max 26 (2 brushes)	12"	5-1/2" CH - 36P74
Convertamatic 17	15"	364147P
Convertamatic 18	16"	5-1/2" CH - 36P74
Convertamatic 20	18"	364147P
Convertamatic 21	19"	5-1/2" CH - 36P74

## A2 Hardware

### Plastic Universal 5" CH

#### Prod No

- 364183P
- 364192P
- 364147P
- 364146P

### Metal Universal 5" CH

#### Prod No

- 364101A
- 364101B
- 364101C
- 364101D

## B1

### Aggressive Stripping

- Replaces High Productivity floor pads
- Aggressive scrubbing of concrete and aggressive stripping of terrazzo and VCT
- Irregular bristle length to assure cleaning on uneven surfaces
- Great for grout lines 1/2" or greater in width
- .060" nylon fibers impregnated with 46 grit silicon carbide
- Available in 11" - 20" dia showerfeed blocks with 1-3/4" trim

Clutch plate and riser block charts are listed on pages 130-131.

## B2

### Aggressive Stripping

#### Block Dia Prod No

#### Replaces High Productivity Pads

- 11" 361100G60-5N
- 12" 361200G60-5N
- 13" 361300G60-5N
- 14" 361400G60-5N
- 15" 361500G60-5N
- 16" 361600G60-5N
- 17" 361700G60-5N
- 18" 361800G60-5N
- 19" 361900G60-5N



# ROTARY BRISTLE MATERIAL GUIDE



Choose the best brush for your specific application. Synthetic materials are the best choice with high quality natural materials as a good alternate. Our fine selection of bristles offers you a choice of solutions for any application.

## Synthetic Bristles

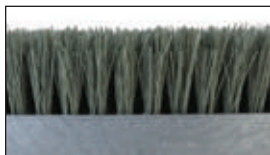

### Colortech™

An aggressive Nylon filament with Silicon Carbide Grit. Use Colortech instead of traditional floor pads for all your floor care needs including stripping, scrubbing, and daily maintenance operations. Six grits to choose from, see page 114 for details.



### Polypropylene

A synthetic bristle material with more durability than plastic; highly resistant to chemicals, fungus, and bacteria. Ideal for floor care programs that require general scrubbing, wet scrubbing, as well as stripping and re-coating operations.



### Nylon

A durable synthetic bristle material with excellent abrasion resistance and bristle bend recovery. Nylon provides very good chemical resistance and is an excellent bristle choice for general scrubbing.

## Natural Bristles



### Union Mix

An economical blend of two or more bristle materials, usually Tampico and Palmyra which is used in general floor buffing/polishing operations.



### Bassine

A natural, high quality coarse bristle material for general scrubbing applications. Economical and durable, Bassine does have limitations when compared to synthetic fibers.



### Steel Wire

Provides excellent chemical resistance and a high degree of abrasion. Primarily used in scrubbing and scarifying concrete floors and surfaces.

**Warning:** Do not use brush or pad with flammable materials (fuels, solvents, thinner, etc.) as serious bodily harm or injury could result from possible fire or explosion. Any brush used for carpet cleaning must be broken in properly or carpet damage could result.

# QUICK REFERENCE GUIDE

## Scrubbing Brushes

Block Dia	Bassine	Poly .022 (Med)	Poly .028 (Stiff)	Nylon .012 (Soft)	Nylon .022 (Med)	Nylon .028 (Stiff)	Nylon .032 (Heavy)	Light Cleaning
11"	361100BA-5N	361100P22-5N	361100P28-5N	361100N12-5N	361100N22-5N	361100N28-5N	361100N32-5N	361100G18-5N
12"	361200BA-5N	361200P22-5N	361200P28-5N	361200N12-5N	361200N22-5N	361200N28-5N	361200N32-5N	361200G18-5N
13"	361300BA-5N	361300P22-5N	361300P28-5N	361300N12-5N	361300N22-5N	361300N28-5N	361300N32-5N	361300G18-5N
14"	361400BA-5N	361400P22-5N	361400P28-5N	361400N12-5N	361400N22-5N	361400N28-5N	361400N32-5N	361400G18-5N
15"	361500BA-5N	361500P22-5N	361500P28-5N	361500N12-5N	361500N22-5N	361500N28-5N	361500N32-5N	361500G18-5N
16"	361600BA-5N	361600P22-5N	361600P28-5N	361600N12-5N	361600N22-5N	361600N28-5N	361600N32-5N	361600G18-5N
17"	361700BA-5N	361700P22-5N	361700P28-5N	361700N12-5N	361700N22-5N	361700N28-5N	361700N32-5N	361700G18-5N
18"	361800BA-5N	361800P22-5N	361800P28-5N	361800N12-5N	361800N22-5N	361800N28-5N	361800N32-5N	361800G18-5N
19"	361900BA-5N	361900P22-5N	361900P28-5N	361900N12-5N	361900N22-5N	361900N28-5N	361900N32-5N	361900G18-5N
20"	362000BA-5N	362000P22-5N	362000P28-5N	362000N12-5N	362000N22-5N	362000N28-5N	362000N32-5N	362000G18-5N





### Scrubbing Brushes

Block Dia	General Cleaning	Scrubbing
11"	361100G22-5N	361100G35-5N
12"	361200G22-5N	361200G35-5N
13"	361300G22-5N	361300G35-5N
14"	361400G22-5N	361400G35-5N
15"	361500G22-5N	361500G35-5N
16"	361600G22-5N	361600G35-5N
17"	361700G22-5N	361700G35-5N
18"	361800G22-5N	361800G35-5N
19"	361900G22-5N	361900G35-5N
20"	362000G22-5N	

### Stripping Brushes

Wire	Stripping	Aggressive Stripping	Concrete Floor
361100W30-5N	361100G50-5N	361100G60-5N	361100G70-5N
361200W30-5N	361200G50-5N	361200G60-5N	361200G70-5N
361300W30-5N	361300G50-5N	361300G60-5N	361300G70-5N
361400W30-5N	361400G50-5N	361400G60-5N	361400G70-5N
361500W30-5N	361500G50-5N	361500G60-5N	361500G70-5N
361600W30-5N	361600G50-5N	361600G60-5N	361600G70-5N
361700W30-5N	361700G50-5N	361700G60-5N	361700G70-5N
361800W30-5N	361800G50-5N	361800G60-5N	361800G70-5N
361900W30-5N	361900G50-5N	361900G60-5N	361900G70-5N
362000W30-5N	362000G50-5N	362000G60-5N	362000G70-5N



# QUICK REFERENCE GUIDE

## Polishing Brushes

Block Dia	Union
11"	361100UN-5N
12"	361200UN-5N
13"	361300UN-5N
14"	361400UN-5N
15"	361500UN-5N
16"	361600UN-5N
17"	361700UN-5N
18"	361800UN-5N
19"	361900UN-5N
20"	362000UN-5N

## Pad Drivers

Short Trim	Long Trim
361100W30-5N	361100G50-5N
361200W30-5N	361200G50-5N
361300W30-5N	361300G50-5N
361400W30-5N	361400G50-5N
361500W30-5N	361500G50-5N
361600W30-5N	361600G50-5N
361700W30-5N	361700G50-5N
361800W30-5N	361800G50-5N
361900W30-5N	361900G50-5N
362000W30-5N	362000G50-5N

## Clutch Plates & Lugs

### 5" CH Clutch Plates

Metal Universal	Plastic Universal
364101A	364183P
364101B	364192P
364101C	364147P
364101D	364146P

### Clip-On Style Clutch Plates

Prod No
364103
364108
364115

### Conventional Style CH Clutch Plates

Prod No
36P3A
36P9
3661238 or 364148P

## Lug Style Mounting Sets

Prod No	Description
36P74	Lug Style Mounting Sets
36P42A	Lug Style Mounting Sets
364174	Lug Style Mounting Sets

## Accessories

Prod No	Description
3613511	Plastic Riser Block
363522	Pad Grab®
363523	Pad Grab® 2000



## Carpet Cleaning Brushes

Block Dia	Nylon Outer - .028 Inner - .022	Nylon .028 (Stiff)	Nylon .022 (Med)	Poly .022 (Med)	Adjust-A-Glide® .025 (Stiff)	Adjust-A-Glide® .018 (Soft)	Dirt Napper System®
11"	361100NDF-5N	361100N28-5N	361100N22-5N	361100P22-5N			
12"	361200NDF-5N	361200N28-5N	361200N22-5N	361200P22-5N	361200A25-5N	361200A18-5N	
13"	361300NDF-5N	361300N28-5N	361300N22-5N	361300P22-5N	361300A25-5N	361300A18-5N	
14"	361400NDF-5N	361400N28-5N	361400N22-5N	361400P22-5N	361400A25-5N	361400A18-5N	
15"	361500NDF-5N	361500N28-5N	361500N22-5N	361500P22-5N	361500A25-5N	361500A18-5N	361500DN-5N
16"	361600NDF-5N	361600N28-5N	361600N22-5N	361600P22-5N	361600A25-5N	361600A18-5N	
17"	361700NDF-5N	361700N28-5N	361700N22-5N	361700P22-5N	361700A25-5N	361700A18-5N	361700DN-5N
18"	361800NDF-5N	361800N28-5N	361800N22-5N	361800P22-5N	361800A25-5N	361800A18-5N	361800DN-5N
19"	361900NDF-5N	361900N28-5N	361900N22-5N	361900P22-5N			361900DN-5N
20"	362000NDF-5N	362000N28-5N	362000N22-5N	362000P22-5N			

## Carpet Cleaning Accessories

Prod No	Description
361300DNB	Bonnet for 15" Dirt Napper
361500DNB	Bonnet for 17" and 18" Dirt Napper
361700DNB	Bonnet for 19" Dirt Napper

## Wood Floor Preparation

### Sand-Away

Block Dia	Prod No
15"	361500SA-5N
16"	361600SA-5N
17"	361700SA-5N
19"	361900SA-5N

## Concrete Floor Preparation

### Scrape-Away

Block Dia	Prod No	Description	Prod No
13"	361300CC	Brackets, Springs & Cutter Blades (set of 3)*	363525
15"	361500CC	Cutter Blades (set of 3)*	363526
17"	361700CC	Brackets & Springs (set of 3)*	363527

\* Standard Scrape-Away uses 2 sets

### Grind-Away

Block Dia	Prod No	Description	Prod No
15"	361500GA	Grit Block Kit (set of 3)	3635828
17"	361700GA		

### Grind-Away Accessories



# SCRUBBING BRUSHES

These long-wearing rotary brushes with stiff bristles are designed for general scrubbing. Available in a choice of bassine, polypropylene, or nylon.

## Bassine

- Stiff fiber for general scrubbing
- Available in 11" - 20" diameter blocks with 1-3/4" trim



**Bassine**

## Polypropylene (Poly)

- For economical, general scrubbing
- .028" stiff bristles for general scrubbing, available in 11" - 20" diameter showerfeed blocks with 1-3/4" trim
- .022" medium bristles for light general scrubbing, available in 11" - 20" diameter showerfeed blocks with 1-3/4" trim



**Polypropylene**

## Nylon

- Long-wearing, general scrub rotary brush
- Extra stiff .032" bristles for extra tough scrubbing, available in 11" - 20" diameter showerfeed blocks with 1-3/4" trim
- .028" stiff bristles for general scrubbing, available in 11" - 20" diameter showerfeed blocks with 1-3/4" trim
- .022" medium bristles for light general scrubbing, available in 11" - 20" diameter showerfeed blocks with 1-3/4" trim
- .012 soft bristles for scrubbing marble and finished concrete, available in 11" - 20" diameter showerfeed blocks with 1-3/4" trim



**Nylon**



### Bassine

Block Dia	Prod No
11"	361100BA-5N
12"	361200BA-5N
13"	361300BA-5N
14"	361400BA-5N
15"	361500BA-5N
16"	361600BA-5N
17"	361700BA-5N
18"	361800BA-5N
19"	361900BA-5N
20"	362000BA-5N

### Poly .022 (Medium)

Block Dia	Prod No
11"	361100P22-5N
12"	361200P22-5N
13"	361300P22-5N
14"	361400P22-5N
15"	361500P22-5N
16"	361600P22-5N
17"	361700P22-5N
18"	361800P22-5N
19"	361900P22-5N
20"	362000P22-5N

### Poly .028 (Stiff)

Block Dia	Prod No
11"	361100P28-5N
12"	361200P28-5N
13"	361300P28-5N
14"	361400P28-5N
15"	361500P28-5N
16"	361600P28-5N
17"	361700P28-5N
18"	361800P28-5N
19"	361900P28-5N
20"	362000P28-5N

### Nylon .012 (Soft)

Block Dia	Prod No
11"	361100N12-5N
12"	361200N12-5N
13"	361300N12-5N
14"	361400N12-5N
15"	361500N12-5N
16"	361600N12-5N
17"	361700N12-5N
18"	361800N12-5N
19"	361900N12-5N
20"	362000N12-5N

### Nylon .022 (Medium)

Block Dia	Prod No
11"	361100N22-5N
12"	361200N22-5N
13"	361300N22-5N
14"	361400N22-5N
15"	361500N22-5N
16"	361600N22-5N
17"	361700N22-5N
18"	361800N22-5N
19"	361900N22-5N
20"	362000N22-5N

### Nylon .028 (Stiff)

Block Dia	Prod No
11"	361100N28-5N
12"	361200N28-5N
13"	361300N28-5N
14"	361400N28-5N
15"	361500N28-5N
16"	361600N28-5N
17"	361700N28-5N
18"	361800N28-5N
19"	361900N28-5N
20"	362000N28-5N

### Nylon .032 (Heavy)

Block Dia	Prod No
11"	361100N32-5N
12"	361200N32-5N
13"	361300N32-5N
14"	361400N32-5N
15"	361500N32-5N
16"	361600N32-5N
17"	361700N32-5N
18"	361800N32-5N
19"	361900N32-5N
20"	362000N32-5N

## STRIPPING BRUSHES

### Steel Wire

- For stripping and scrubbing of rough concrete surfaces
- High carbon steel, 30 ga. wire fill
- Available in 11" - 20" diameter blocks with 1.56" trim

Block Dia	Prod No
11"	361100W30-5N
12"	361200W30-5N
13"	361300W30-5N
14"	361400W30-5N
15"	361500W30-5N
16"	361600W30-5N
17"	361700W30-5N
18"	361800W30-5N
19"	361900W30-5N
20"	362000W30-5N



Steel Wire

**Warning:** Do not use brushes, pads, or tools with flammable materials as serious bodily injury could result.



# POLISHING BRUSHES

## Union

- A blend of palmyra and white tampico fiber for general purpose polishing
- Available in 11" - 20" diameters with 1-3/4" trim

Block Dia	Prod No
11"	361100UN-5N
12"	361200UN-5N
13"	361300UN-5N
14"	361400UN-5N
15"	361500UN-5N
16"	361600UN-5N
17"	361700UN-5N
18"	361800UN-5N
19"	361900UN-5N
20"	362000UN-5N



Union

# PAD DRIVER BRUSHES & ACCESSORIES

## Short Trim Pad Driver

- 1/2" long, polypropylene bristles unevenly trimmed and widely spaced to hold a floor pad
- Available in 11" - 20" diameter
- Can be converted for use on some high speed machines\*
- Order with riser 3613511 for use with swing machines



Short Trim Pad Driver

## Long Trim Pad Driver

- Stiff polypropylene bristles trimmed to 1" long
- Available in 11" - 20" diameter blocks



Long Trim Pad Driver

\* Prep charge may be required, which includes cutting the center hole and static balancing. Check the machine listing on pages 132-145 or call Customer Service for more information.



### Pad Grab® Pad Holder

- Unique three piece construction, teeth on base and washer hold pad in place, retainer slides on the washer for easy pad installation and removal
- Fits most pads, from stripping to buffing
- Holds pads on center without tearing
- Molded of high-impact plastic for extra strength
- Easily and securely fastens to brush block with six screws, included



363522 – Pad Grab Pad Holder

### Pad Grab 2000 Pad Holder

- Includes 6 screws for easy mounting
- Made of high impact polymer for extra strength and long life
- Attaches quickly to different pad thicknesses and holds the pad on center without tearing
- Retainer ring always seats itself for proper pad positioning and leveling
- Eliminates right/left rotation considerations



363523 – Pad Grab 2000 Pad Holder

#### Short Trim Pad Driver

Block Dia	Prod No
11"	361100PDS-5N
12"	361200PDS-5N
13"	361300PDS-5N
14"	361400PDS-5N
15"	361500PDS-5N
16"	361600PDS-5N
17"	361700PDS-5N
18"	361800PDS-5N
19"	361900PDS-5N
20"	362000PDS-5N

#### Long Trim Pad Driver

Block Dia	Prod No
11"	361100PDL-5N
12"	361200PDL-5N
13"	361300PDL-5N
14"	361400PDL-5N
15"	361500PDL-5N
16"	361600PDL-5N
17"	361700PDL-5N
18"	361800PDL-5N
19"	361900PDL-5N
20"	362000PDL-5N

#### Pad Grab Pad Holders

Description	Prod No
Pad Grab	363522
Pad Grab 2000	363523

**Warning:** Do not use brushes, pads, or tools with flammable materials as serious bodily injury could result.



# CARPET CLEANING BRUSHES

## Karpet Kare™ Nylon

- Excellent for general scrubbing
- 11" - 20" showerfeed blocks with 1-3/4" trim
- Outer rows of .028" nylon bristles and inner rows of .022" nylon bristles
- Requires a few minutes of concrete surface "break-in" operation before use



Karpet Kare Nylon

## Nylon

- Long wearing nylon for effective carpet cleaning
- Available in .028" stiff nylon in 11" to 20" diameter showerfeed blocks for general cleaning; or .022" medium stiff nylon in 11" - 20" diameter showerfeed blocks for light cleaning; 1-3/4" trim



Nylon

## Polypropylene

- For economical carpet cleaning
- .022" polypropylene bristles with a 1-3/4" trim
- Available in 11" - 20" diameter showerfeed blocks



Polypropylene

## Dirt Napper System®

- Carpet Cleaning System consisting of a polyester brush and a bonnet for fast, effective cleaning
- Outside rows of 1-1/4" trim bristles scrub carpet
- Inside rows of .31" trim bristles hold absorbent looped microfiber bonnet in place
- Available in 15", 17", 18", and 19" diameter plastic blocks with 1" riser
- Replacement bonnets available, specify Dirt Napper size when ordering, packed 6 per case



Dirt Napper System

## Adjust-A-Glide®

- Polyester bristle brush effectively scrubs carpet while the smooth glide plate supports the weight of the machine for easier operator handling, while reducing operator fatigue
- .025" for general cleaning; or .018" for light cleaning
- Available in 12" - 18" diameter showerfeed plastic blocks



Adjust-A-Glide

Clutch Plates for Carpet Cleaning Brushes are sold separately. See Machine Listing on pages 132-145 for recommended Clutch Plate.





### Karpet Kare Nylon

Outer Rows .028 (Stiff)

Inner Rows .022 (Med.)

Block Dia	Prod No
11"	361100NDF-5N
12"	361200NDF-5N
13"	361300NDF-5N
14"	361400NDF-5N
15"	361500NDF-5N
16"	361600NDF-5N
17"	361700NDF-5N
18"	361800NDF-5N
19"	361900NDF-5N
20"	362000NDF-5N

### Nylon .028 (Stiff)

Block Dia	Prod No
11"	361100N28-5N
12"	361200N28-5N
13"	361300N28-5N
14"	361400N28-5N
15"	361500N28-5N
16"	361600N28-5N
17"	361700N28-5N
18"	361800N28-5N
19"	361900N28-5N
20"	362000N28-5N

### Nylon .022 (Medium)

Block Dia	Prod No
11"	361100N22-5N
12"	361200N22-5N
13"	361300N22-5N
14"	361400N22-5N
15"	361500N22-5N
16"	361600N22-5N
17"	361700N22-5N
18"	361800N22-5N
19"	361900N22-5N
20"	362000N22-5N

### Poly .022 (Medium)

Block Dia	Prod No
11"	361100P22-5N
12"	361200P22-5N
13"	361300P22-5N
14"	361400P22-5N
15"	361500P22-5N
16"	361600P22-5N
17"	361700P22-5N
18"	361800P22-5N
19"	361900P22-5N
20"	362000P22-5N

### Dirt Napper System

Block Dia	Prod No
11"	N/A
12"	N/A
13"	N/A
14"	N/A
15"	361500DN-5N
16"	N/A
17"	361700DN-5N
18"	361800DN-5N
19"	361900DN-5N
20"	N/A

### Carpet Cleaning Accessories

Block Dia	Prod No
Bonnet for 15" Dirt Napper	361300DNB
Bonnet for 17" and 18" Dirt Napper	361500DNB
Bonnet for 19" Dirt Napper	361700DNB

### Adjust-A-Glide .018 (Soft)

Block Dia	Prod No
11"	N/A
12"	361200A18-5N
13"	361300A18-5N
14"	361400A18-5N
15"	361500A18-5N
16"	361600A18-5N
17"	361700A18-5N
18"	361800A18-5N
19"	N/A
20"	N/A

### Adjust-A-Glide .025 (Stiff)

Block Dia	Prod No
11"	N/A
12"	361200A25-5N
13"	361300A25-5N
14"	361400A25-5N
15"	361500A25-5N
16"	361600A25-5N
17"	361700A25-5N
18"	361800A25-5N
19"	N/A
20"	N/A

**Warning:** Do not use brushes, pads, or tools with flammable materials as serious bodily injury could result.

# CONCRETE FLOOR PREPARATION

## Scrape-Away®

- The productive, economical, and environmentally safe method for scraping and preparing concrete floors and stripping of film coatings, packed soils, ice, etc
- Equipped with 6 replaceable carbon steel cutter blades; each blade has 8 cutting edges; three replacement blades per set
- Available in 13", 15", and 17" sizes
- Scrape-Away can be fit with Grind-Away grit blocks
- Order 2" smaller than machine size



Scrape-Away

### Scrape-Away

Block Dia	Prod No
13"	361300CC
15"	361500CC
17"	361700CC

### Scrape-Away Accessories

Block Dia	Prod No
Brackets, Springs & Cutter Blades (set of 3)*	363525
Cutter Blades (set of 3)*	363526
Brackets & Springs (set of 3)*	363527

\* Standard Scrape-Away uses 2 sets



363526

Scrape-Away and Grind-Away tools are designed for use only on 175 rpm rotary machines with 1 HP or greater. The heavy-duty circular aluminum casting has a 5" center hole, and a metal clutch plate is required. These tools cannot be used with riser blocks. When the machine listing on pages 132-145 recommends a "P" series universal clutch plate, use the proper metal clutch plate from the table on the following page.

### Important:

All concrete floor tools are designed for use only by experienced rotary floor machine operators wearing protective eyewear, footwear, and dust mask. Always use the proper size standard 175 rpm rotary floor machine, equipped with the proper heavy-duty metal clutch plate. Do not use with "P" series or 364101 series universal clutch plates. Do not use with flammable materials.



### Grind-Away®

- For smoothing and finishing after concrete patchwork
- Equipped with three replaceable silicon carbide grit blocks; three replacement grit blocks per set
- Available in 15" and 17" sizes.
- Grind-Away can be fit with Scrape-Away cutting hardware
- For dry use only
- Order 2" smaller than machine size

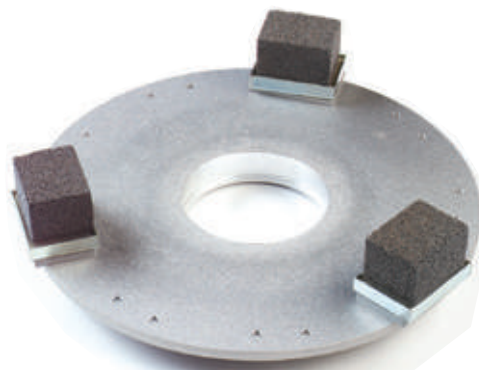

Grind-Away

### Grind-Away

Block Dia	Prod No
15"	361500GA
17"	361700GA

### Grind-Away Accessories

Block Dia	Prod No
Grit Block Kit (set of 3)	3635828

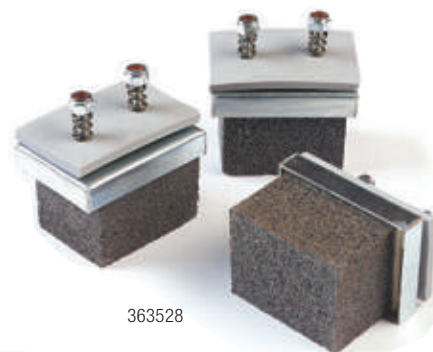

363528

### Universal Metal Plate

Prod No	
364101A	Instead of
364101B	Instead of
364101C	Instead of
364101D	Instead of

### Universal Plastic Plate

Prod No.
364183P
364192P
364147P
364146P



364101A

## WOOD FLOOR PREPARATION

### Sand-Away® Sanding Disk Driver for Wood Floors

- Durable plastic block with the finest quality felt face and a molded plastic holding cup securely holds sandpaper discs
- Equipped with a 1-7/16" plastic riser with 5" center hole for use with Plastic Universal Clutch Plates or Standard Metal Universal Clutch Plates
- Available in 15", 16", 17", and 19" sizes



Sand-Away

### Sand-Away

Block Dia	Prod No
15"	361500SA-5N
16"	361600SA-5N
17"	361700SA-5N
19"	361900SA-5N

**Warning:** Do not use brushes, pads, or tools with flammable materials as serious bodily injury could result.



# CLUTCH PLATES & LUGS

Clutch plates available in standard metal, plastic, or heavy-duty metal. Refer to the cross reference chart at the bottom of this page for options.

## Standard (Metal) Universal Clutch Plates

- Cast of durable zinc alloy with a 5" center hole
- Can be used instead of plastic ("P" Series) plates for the same applications
- Numbers for plates are listed in the table



## Plastic Universal Clutch Plates

- Durable ("P" Series) plates molded to the same tight dimensions as metal counterparts with a 5" center hole and are recommended for most applications
- Plastic plates won't stick to the drive hub; makes installation and removal easy



### Metal Universal 5" CH

**Prod No**

364101A

364101B

364101C

364101D

### Plastic Universal 5" CH

**Prod No**

364183P

364192P

364147P

364146P

**Warning:** Do not use brushes, pads, or tools with flammable materials as serious bodily injury could result.



## Additional Clip-On Style Plates

- Match OEM design for brushes to fit automatic scrubbers

### Clip-On Style Clutch Plates

Center Hole	Prod No
2-61/64" CH	364103
4-7/8" CH	364115
5" CH	364105
5" CH	364108
5" CH	364109
5" CH	364110
5" CH	364112



### Conventional Style CH

Center Hole	Prod No
3-3/8" CH	36P9
4" CH	3661238
4" CH	36P3A
5" CH	364148P



## LUGS

### Metal Lugs

- Match OEM design for mounting on this style drive
- Set of 3 lugs

### Lug Style Mounting Sets

Center Hole	Prod No
5-17/32" CH	36P74
2-7/8" CH	36P42A
Plastic, 5-17/32" CH	364174



### Plastic Riser Blocks

- For use with plastic block brushes
- 1-7/16" high x 6-1/2" diameter; specify center hole size

### Plastic Riser Block

Size	Prod No
6-1/2" Dia. (1-7/16" High) Specify Center Hole Size	3613511



# ROTARY BRUSHES | MACHINE LISTINGS

The listings below will assist you in selecting the correct brush block size and clutch plate for your equipment.

- Scrubbing brushes and long-trim pad drivers are usually 2" smaller than the machine size. This is the block diameter listed in the table.
- Short-trim pad drivers are usually 1" smaller than the machine size. Add 1" to the block size listed in this table for short-trim pad drivers.
- Automatic scrubbers will use brushes, short-trim pad drivers, and long-trim pad drivers as listed in this table.

Brushes for certain machine models may require special preparation, or may be available in select fill types.

Call Customer Service at 800-654-8210 for information on machines not listed.

Machine Manufacturer's Model No	Block Dia	Suggested Carlisle Plate	Suggested EZ Snap Plate
<b>Advance (Nilfisk-Advance)</b>			
See Nilfisk-Advance on pages 138-140.			
<b>American-Lincoln</b>			
17 Deluxe, 17 Deluxe CR	15"	364192P	364192BD
22	20"	364192P	364192BD
66 (2 brushes)	14"	364105	364200BD & 364105
81 (2 brushes)	17"	364105	364200BD & 364105
116	14"	364192P	364192BD
119	17"	364192P	364192BD
121	19"	364192P	364192BD
151, 156, 161	14"	364192P	364192BD
150 Series	12"	364192P	364192BD
152 Series	17"	364192P	364192BD
160 Series	12"	364192P	364192BD
161	14"	364192P	364192BD
162 Series	17"	364192P	364192BD
188-01	13"	364192P	364192BD
188-005	15"	364192P	364192BD
189	15"	364192P	364192BD
191-11, 191-15	13"	364192P	364192BD
192, 198	15"	364192P	364192BD
193 Series	12"	364192P	364192BD
197 Series	13"	364192P	364192BD
214, 214HD	13"	364192P	364192BD
215, 216	14"	364192P	364192BD
219	17"	364192P	364192BD
221, S221	19"	364192P	364192BD
301	18"	364192P	364192BD
314	12"	364192P	364192BD

Machine Manufacturer's Model No	Block Dia	Suggested Carlisle Plate	Suggested EZ Snap Plate
316, 316-021	14"	364192P	364192BD
317	15"	364192P	364192BD
319	17"	364192P	364192BD
320	18"	364192P	364192BD
321	19"	364192P	364192BD
322	20"	364192P	364192BD
621CE	19"	364192P	364192BD
721	19"	364192P	364192BD
726 (2 brushes)	13" - 4" CH	N/A	N/A
730 (2 brushes)	14" - 4" CH	N/A	N/A
936 (2 brushes)	17" - 4" CH	N/A	N/A
2112A	11"	364192P	364192BD
Champion 14	12"	364192P	364192BD
Champion 15	13"	364192P	364192BD
Champion 17	15"	364192P	364192BD
Champion 19	17"	364192P	364192BD
EM-16, EPM-16	14"	364192P	364192BD
Gold Line 14	12"	364192P	364192BD
Gold Line 15	13"	364192P	364192BD
Gold Line 17	15"	364192P	364192BD
Mini-Max 26 (2 brushes)	13" - 5.53" CH	36P74	36P74BD
S-214	13"	364192P	364192BD
S-221	19"	364192P	364192BD
SD-14	13"	364192P	364192BD
SD-15	14"	364192P	364192BD
SD-16	14"	364192P	364192BD
SD-18	17"	364192P	364192BD
SD-19	17"	364192P	364192BD
SD-20	19"	364192P	364192BD
<b>Aztec</b>			
Power Scrub 20	19" - 5.53" CH	36P74	36P74BD
ProScrub 20	19" - 5.53" CH	36P74	36P74BD
<b>Betco/Powerbuff</b>			
20HD	18"	364192P	364192BD
32	16" - 5.53" CH	36P74	36P74BD
AS2600B, AS2600T (2 brushes)	13" - 5.53" CH	36P74	36P74BD
AS3200 (2 brushes)	16" - 5.53" CH	36P74	36P74BD
FL 17, FL 17HD, FL 17DS	15"	364192P	364192BD
FL 19, FL 19HD, FL 19DS	17"	364192P	364192BD
Foreman AS20B	18"	364192P	364192BD
Foreman 26 (2 brushes)	13" - 5.53" CH	36P74	36P74BD
Foreman 32 (2 brushes)	16" - 5.53" CH	36P74	36P74BD
<b>Bluestar</b>			
607043-33 (2 brushes)	15" - 5.53" CH	36P74	36P74BD
607045-27 (2 brushes)	12" - 5.53" CH	36P74	36P74BD

**CALL\*** – Use the Rotary Wizard on the Carlisle website located in the Support section or call Customer Service at 800-654-8210.

**WARNING:** Do not use brushes, pads, or tools with flammable materials as serious bodily injury could result.





Machine Manufacturer's Model No	Block Dia	Suggested Carlisle Plate	Suggested EZ Snap Plate
607046-24, 607047-24 (2 brushes)	11" - 5.53" CH	36P74	36P74BD
607395-17	15"	364115	364200BD & 364115
608852-20	19" - 5.53" CH	36P74	36P74BD
612209-17, 612210-14	15"	364192P	364192BD
61221-20, 612212-20	18"	364192P	364192BD
<b>Breuer (Tornado)</b>			
See Tornado on pages 143-144.			
<b>Cassidy (Clean-O-Matic)</b>			
14, 14A, 140	12"	364192P	364192BD
15, VP-15, 150	13"	364192P	364192BD
16, 160	14"	364192P	364192BD
17, VP-17, 170	15"	364192P	364192BD
190	17"	364192P	364192BD
20, VP-20	18"	364192P	364192BD
<b>Clarke</b>			
34 RST (2 brushes)	17"	364105	364200BD & 364105
820	19"	364192P	364192BD
1700 Mini-Scrubber	17"	CALL*	CALL*
2000 Mini-Scrubber	18"/19"	CALL*	CALL*
2400 (2 brushes)	13"	CALL*	CALL*
6200 Rider (3 brushes)	14"	364105	364200BD & 364105
Burnisher 1000, 1500, 2000 - high speed pad driver	18"	CALL*	CALL*
Burnisher 2000B, 2000E - high speed pad driver	19"	CALL*	CALL*
C-15	13"	364192P	364192BD
C-16, C-1600	14"	364192P	364192BD
C-18, C-1800, C-1800HS	16"	364192P	364192BD
C-20, C-2000	18"	364192P	364192BD
C-22	20"	364192P	364192BD
C2K 13	11"	364192P	364192BD
C2K 16, C2K 160, C2K 1600, C2K 1600HS, C2K 1600DS	14"	364192P	364192BD
C2K 18, C2K 180, C2K 1800, C2K 1800HS	16"	364192P	364192BD
C2K 200, C2K 2000, C2K 2000HS, C2K 2000DS	18"	364192P	364192BD
CFP-130	11"	364183P	364200BD & 364183P
CFP-170, 1700	15"	364183P	364200BD & 364183P
CFP-200, 2000, 2000DS	18"	364192P	364192BD
Compact Leader 1700B, 1700E	16"/17"	CALL*	CALL*
Compact Leader 2000B, 2000E	18"/19"	CALL*	CALL*

Machine Manufacturer's Model No	Block Dia	Suggested Carlisle Plate	Suggested EZ Snap Plate
Direct Speed 20 (DS20)	18"	364192P	364192BD
E-15	13"	364192P	364192BD
EM-16	14"	364192P	364192BD
E-18	16"	364192P	364192BD
Encore L17	16/17"	CALL*	CALL*
Encore L20, S20, S20E	18"/19"	CALL*	CALL*
Encore L28, S28 (2 brushes)	14"	364105	364200BD & 364105
Encore 30 (2 brushes)	15"	364105	364200BD & 364105
Encore 32 (2 brushes)	16"	364105	364200BD & 364105
Encore 33, L33, S33, 34, R34 (2 brushes)	17"	364105	364200BD & 364105
Encore 35 (2 brushes)	16"	364105	364200BD & 364105
Encore L38, R38, S38 (2 brushes)	19"	CALL*	CALL*
Encore L2426 (2 brushes)	13"	364105	364200BD & 364105
Encore S2426 (2 brushes)	13"	CALL*	CALL*
FM-1300 (old)	11" - 3.38" CH	36P9	N/A
FM-13 (new)	11"	364192P	364192BD
FM-14	12"	364192P	364192BD
FM-15, FM-1500	13"	364192P	364192BD
F-16, FM-16	14"	364192P	364192BD
FM-17, FM-1700HS	15"	364192P	364192BD
FM-1700	15"	364147P	364200BD & 364147P
FM-18	16"	364192P	364192BD
FM-20, FM-2000HS	18"	364192P	364192BD
FM-2000	18"	364147P	364200BD & 364147P
Focus 17	17"	364148P	364148BD
Focus 20	20"	364148P	364148BD
Focus 28 (2 brushes)	14"	364105	364200BD & 364105
Focus 33 (2 brushes)	17"	CALL*	CALL*
Focus 34 (2 brushes)	17"	364105	364200BD & 364105
Focus 38 (2 brushes)	19"	CALL*	CALL*
Focus II L20, S20	18"	364148P	364148BD
Focus II 26 (2 brushes)	13"	364105	364200BD & 364105
Focus II 28 (2 brushes)	14"	364105	364200BD & 364105
Focus II Large (2 brushes)	17"	364105	364200BD & 364105
Focus II Microrider 28	14"	364105	364200BD & 364105
GM-15	13"	364192P	364192BD
GM-17	15"	364192P	364192BD
GM-18	16"	364192P	364192BD
IN-15	13"	364192P	364192BD
IN-17	15"	364192P	364192BD
IN-20	18"	364192P	364192BD

CALL\* – Use the Rotary Wizard on the Carlisle website located in the Support section or call Customer Service at 800-654-8210.

**WARNING:** Do not use brushes, pads, or tools with flammable materials as serious bodily injury could result.

# ROTARY BRUSHES | MACHINE LISTINGS



Machine Manufacturer's Model No	Block Dia	Suggested Carlisle Plate	Suggested EZ Snap Plate
<b>Clarke (cont.)</b>			
LP-80, LP-136	15"	364192P	364192BD
Leader 2400, 2400D, 2400UDS (2 brushes) high speed pad driver	13"	364105	364200BD & 364105
Leader 3200, 3400 (2 brushes) high speed pad driver	17"	364105	364200BD & 364105
MP-18	16"	364192P	364192BD
P-13	11"	364192P	364192BD
P-15	13"	364192P	364192BD
P-17	15"	364192P	364192BD
P-20	18"	364192P	364192BD
PE-20	19"	364192P	364192BD
P-22	20"	364192P	364192BD
S-13	11"	364192P	364192BD
S-16	14"	364192P	364192BD
S-18	16"	364192P	364192BD
S-20, SS-20	18"	364192P	364192BD
TB-60 (2 brushes) - high speed pad driver	13"	364105	364200BD & 364105
TB-80 (2 brushes) - high speed pad driver	17"	364105	364200BD & 364105
Vantage 17	15"	364148P	364148BD
VP-16	14"	364192P	364192BD
VP-18	16"	364192P	364192BD
VP-20	18"	364192P	364192BD
Vision - 17, 17B, 17BT, 17E (Compact)	16"	364192P	364192BD
Vision 20	18"/19"	CALL*	CALL*
Vision 21; 21i (2 brushes)	11"	CALL*	CALL*
Vision 26 (2 brushes)	14"	364105	364200BD & 364105
Vision 32, 32i, 32ix (2 brushes)	17"	364105	364200BD & 364105
Vision 38 (2 brushes)	19"	CALL*	CALL*
Vision 3400 (2 brushes)	17"	364105	364200BD & 364105
Vision V (2 brushes)	13"	364105	364200BD & 364105
<b>Crusader</b>			
9013, C-13	11"	364192P	364192BD
9017, C-17	15"	364192P	364192BD
9002, C-20, 9003, C-20-2SP	18"	364192P	364192BD
<b>Dart</b>			
15A	13"	364192P	364192BD
18A	16"	364192P	364192BD
21A	19"	364192P	364192BD
130, 131	11"	364192P	364192BD
140, 141, 142	12"	364192P	364192BD
150, 151, 152, 153	13"	364192P	364192BD
160, 161, 162	14"	364192P	364192BD
170, 171, 172	15"	364192P	364192BD
190, 191	17"	364192P	364192BD

Machine Manufacturer's Model No	Block Dia	Suggested Carlisle Plate	Suggested EZ Snap Plate
341, 342, 343	12"	364192P	364192BD
360, 361, 362	14"	364192P	364192BD
371, 372	15"	364192P	364192BD
390, 391	17"	364192P	364192BD
423	19"	364192P	364192BD
430	11"	364192P	364192BD
451, 452, 453	13"	364192P	364192BD
482, 483	16"	364192P	364192BD
630, 631	11"	364192P	364192BD
641, 642, 643	12"	364192P	364192BD
661, 662, 663	14"	364192P	364192BD
672, 673	15"	364192P	364192BD
692, 693	17"	364192P	364192BD
723	19"	364192P	364192BD
751, 752, 753	13"	364192P	364192BD
782, 783	16"	364192P	364192BD
823	19"	364192P	364192BD
863	14"	364192P	364192BD
873	15"	364192P	364192BD
893	17"	364192P	364192BD
921	19"	364192P	364192BD
961, 962	14"	364192P	364192BD
971, 972	15"	364192P	364192BD
991	17"	364192P	364192BD
G1 (180 Series)	14"	364192P	364192BD
<b>Dayton</b>			
1715HD	15"	364192P	364192BD
2015HD	18"	364192P	364192BD
<b>Eureka (Sanitaire)</b>			
15 Sanitaire	13"	364192P	364192BD
17 Sanitaire	15"	364192P	364192BD
20 Sanitaire	18"	364192P	364192BD
SC6001	11"	364192P	364192BD
SC6005	13"	364192P	364192BD
SC6010, SC6015, SC6030	15"	364192P	364192BD
SC6025	18"	364192P	364192BD
<b>EDIC</b>			
Saturn 13	11"	364192P	364192BD
Saturn 17	15"	364192P	364192BD
Saturn 20	18"	364192P	364192BD
<b>Factory Cat/Tomcat (RPS)</b>			
25, 250, 2500 (2 brushes)	12"	364108 or 364110**	364108BD or 364200BD/364110
250-13	12"	364108 or 364110**	364108BD or 364200BD/364110
250-15	14"	364108 or 364110**	364108BD or 364200BD/364110
250-17	16"	364108 or 364110**	364108BD or 364200BD/364110

**CALL\*** – Use the Rotary Wizard on the Carlisle website located in the Support section or call Customer Service at 800-654-8210.

**WARNING:** Do not use brushes, pads, or tools with flammable materials as serious bodily injury could result.





Machine Manufacturer's Model No	Block Dia	Suggested Carlisle Plate	Suggested EZ Snap Plate
27, 2700 (2 brushes)	13"	364108 or 364110**	364108BD or 364200BD/364110
29, 29SS, 290D (2 brushes)	14"	364108 or 364110**	364108BD or 364200BD/364110
3400D, Magnum 34 (2 brushes)	16"	364108 or 364110**	364108BD or 364200BD/364110
35, 35SS, 350, 350D (2 brushes)	16"	364108 or 364110**	364108BD or 364200BD/364110
38, 40, 40HD, 3700 (2 brushes)	18"	364108 or 364110**	364108BD or 364200BD/364110
390D	19"	364108 or 364110**	364108BD or 364200BD/364110
490D (2 brushes)	16"	364108 or 364110**	364108BD or 364200BD/364110
52, 5100 (3 brushes)	17"	364108 or 364110**	364108BD or 364200BD/364110
550D (2 brushes)	18"	364108 or 364110**	364108BD or 364200BD/364110
GTX26 (2 brushes)	12"	364108 or 364110**	364108BD or 364200BD/364110
GTX30 (2 brushes)	14"	364108 or 364110**	364108BD or 364200BD/364110
GTX34 (2 brushes)	16"	364108 or 364110**	364108BD or 364200BD/364110
GTX 250-26D (2 brushes)	12"	364108 or 364110**	364108BD or 364200BD/364110
Magnum 26D (2 brushes)	12"	364108 or 364110**	364108BD or 364200BD/364110
Magnum 30 (2 brushes)	14"	364108 or 364110**	364108BD or 364200BD/364110
Mini Mag 17	16"	364108 or 364110**	364108BD or 364200BD/364110
Mini Mag 20	19"	364108 or 364110**	364108BD or 364200BD/364110
Mini Mag 26D (2 brushes)	12"	364108 or 364110**	364108BD or 364200BD/364110
SS1017, SS1517HD, SS1517-2S	15"	364192P	364192BD
SS1020, SS1520 HD, SS1520-2S	18"	364192P	364192BD
XP-370-40D	20"	364108 or 364110**	364108BD or 364200BD/364110
XP-370-34D, 52, 5100	17"	364108 or 364110**	364108BD or 364200BD/364110

\*\* When ordering rotary brushes, specify clutch plate style: 6 point 364108 or 8 point 364110

**General**

1000 - high speed pad driver	18"	CALL*	CALL*
2000DC - high speed pad driver	18"	CALL*	CALL*
GF-15	13"	364192P	364192BD
GF-17, GVS-17	15"	364192P	364192BD
GF-19, GVS-19	16"	364192P	364192BD
GF-21, GVS-21	18"	364192P	364192BD
GF-23	20"	364192P	364192BD
K-12, KC-12, KR-12	11"	364192P	364192BD
KL-13, KR-13	11"	364192P	364192BD
KC14DHS	12"	364192P	364192BD
K-14, KC-14, KL-14, KR-14	13"	364192P	364192BD
K-15, KL-15	13"	364192P	364192BD
KC16DHS	14"	364192P	364192BD
K-16, KC-16, KL-16, KR-16	15"	364192P	364192BD

Machine Manufacturer's Model No	Block Dia	Suggested Carlisle Plate	Suggested EZ Snap Plate
KC-17, KL-17, KR-17	15"	364192P	364192BD
KC18DHS	16"	364192P	364192BD
K-18, KC-18, KR-18	16"	364192P	364192BD
KC20DHS	18"	364192P	364192BD
KC-20, KR-20	18"	364192P	364192BD
K-22, KC-22, KR-22	20"	364192P	364192BD
S-13	11"	364192P	364192BD
S-15	13"	364192P	364192BD
S-18	16"	364192P	364192BD
S-22	20"	364192P	364192BD

NOTE: Floor machine serial number identifies the clutch plate to be used. 84xxx or lower use 364183P. 85xxx or higher take 364192P.

**Hawk**

EYAS 13	11"	364192P	364192BD
EYAS 15	13"	364192P	364192BD
EYAS 17	15"	364192P	364192BD
HP 1017, HP 1517HD	15"	364192P	364192BD
HP 1020, HP 1520HD	18"	364192P	364192BD

**Hild**

2-17	15"	364146P	364200BD & 364146P
17-Pro II	15"	364146P	364200BD & 364146P
20-Pro II	18"	364146P	364200BD & 364146P
21	18"	364146P	364200BD & 364146P
22A-Pro II	20"	364146P	364200BD & 364146P
219	17"	364146P	364200BD & 364146P
A-14	12" - 2.13" CH	N/A	N/A
C-16	14"	364146P	364200BD & 364146P
C-18	16"	364146P	364200BD & 364146P
C-Master 16	14" - 2.13" CH	N/A	N/A
CP-15	13"	364146P	364200BD & 364146P
D-19	17"	364146P	364200BD & 364146P
D-Master 19	17" - 3.25" CH	N/A	N/A
F-22	20"	364146P	364200BD & 364146P
G-18	16"	364146P	364200BD & 364146P
GP 15A	13"	364146P	364200BD & 364146P
H-22	20"	364146P	364200BD & 364146P
Hi-20 - high speed pad driver	18"	CALL*	CALL*
HP-13	11"	364146P	364200BD & 364146P
HP-15	13"	364146P	364200BD & 364146P
HP-16	14"	364146P	364200BD & 364146P
HP-18	16"	364146P	364200BD & 364146P

CALL\* – Use the Rotary Wizard on the Carlisle website located in the Support section or call Customer Service at 800-654-8210.

**WARNING:** Do not use brushes, pads, or tools with flammable materials as serious bodily injury could result.

# ROTARY BRUSHES | MACHINE LISTINGS



Machine Manufacturer's Model No	Block Dia	Suggested Carlisle Plate	Suggested EZ Snap Plate
<b>Hild (cont.)</b>			
K-12-1/2, K-13	11"	364146P	364200BD & 364146P
L-14, P-14	12"	364146P	364200BD & 364146P
L-15	13"	364146P	364200BD & 364146P
Mach 1100, 1500 - high speed pad driver	18"	CALL*	CALL*
P-13	11"	364146P	364200BD & 364146P
P-15	13"	364146P	364200BD & 364146P
P-16	14"	364146P	364200BD & 364146P
P-17	15"	364146P	364200BD & 364146P
P-18	16"	364146P	364200BD & 364146P
P-22A	20"	364146P	364200BD & 364146P
PRO2-17	15"	364146P	364200BD & 364146P
PRO2-20	18"	364146P	364200BD & 364146P
PRO2-22A (22A-PROII)	20"	364146P	364200BD & 364146P
UC-16	14"	364146P	364200BD & 364146P
UC-17	15"	364146P	364200BD & 364146P
UD-19, UD-219	17"	364146P	364200BD & 364146P
UG-18	16"	364146P	364200BD & 364146P
VA-14	12"	364146P	364200BD & 364146P
<b>Hillyard</b>			
16" Hillboy	14" - 5" CH	N/A	N/A
17" Hillboy	15" - 5.63" CH	N/A	N/A
21" Hillboy	18" - 5.63" CH	N/A	N/A
Deluxe Single 14	12"	364147P	364200BD & 364147P
Standard Single 16	14"	364147P	364200BD & 364147P
Standard Single 18	16"	364147P	364200BD & 364147P
Standard Single 20	18"	364147P	364200BD & 364147P
<b>Holt (Pullman-Holt)</b>			
See Pullman-Holt on pages 141-142.			
<b>Hoover</b>			
C5023	14"	364192P	364192BD
C5025, C5033, C5035	18"	364192P	364192BD
C5027	16"	364192P	364192BD
C5029 - high speed pad driver	18"	CALL*	CALL*
C5031	15"	364192P	364192BD
F7089	15"	364147P	364200BD & 364147P
F7091, F7093	18"	364147P	364200BD & 364147P
F7095 - high speed pad driver	18"	CALL*	CALL*

Machine Manufacturer's Model No	Block Dia	Suggested Carlisle Plate	Suggested EZ Snap Plate
<b>Huntington</b>			
12, 13	11"	3661238	N/A
16, 16B, 16G, 16H	14"	3661238	N/A
18, 18P	16"	3661238	N/A
20, 20F, 20H	18"	3661238	N/A
20J	18"	364101B	364192BD
<b>IPC Eagle</b>			
CT15	13" - 5.53" CH	36P74	36P74BD
CT40-BT50	18" - 5.53" CH	36P74	36P74BD
CT60-B50	18" - 5.53" CH	36P74	36P74BD
CT70-24 (2 brushes)	12" - 5.53" CH	36P74	36P74BD
CT90 (2 brushes)	16" - 5.53" CH	36P74	36P74BD
<b>Kent/Euroclean</b>			
170E	15"	364192P	364192BD
1000E	18"	364192P	364192BD
C-13, 13"	11" - 5.63" CH	N/A	N/A
C-13, 15"	14" - 5.63" CH	N/A	N/A
C-15	15" - 5" CH	N/A	N/A
C-18	17" - 5" CH	N/A	N/A
D-20	19" - 5" CH	N/A	N/A
E-12, E-13	11"	364192P	364192BD
E-17	16"	364148P	364148BD
ECFM 17	15"	364192P	364192BD
ECFM 20	18"	364192P	364192BD
GA-15	13"	364192P	364192BD
GA-17	15"	364192P	364192BD
GA-20	18"	364192P	364192BD
K-12, KM-13	11" - 5" CH	N/A	N/A
K-13, K-14	11" - 5" CH	N/A	N/A
K-15, K-16	14" - 5" CH	N/A	N/A
K-17, K-17HD, K-117	15" - 5" CH	N/A	N/A
KA-17 Select Scrub	15"	364192P	364192BD
KA-20BT, KA-20E, KA-20B	19"	364192P	364192BD
KA-26, KA-26BT (2 brushes)	12" - 2.88" CH	36P42A	N/A
KA-26HD (2 brushes)	13" - 2.88" CH	36P42A	N/A
KA-27 Dura-Scrub (2 brushes)	13" - 2.88" CH	36P42A	N/A
KA-27SS, KA-27SSA Select Scrub (2 brushes)	13" - 2.88" CH	36P42A	N/A
KA-32 (2 brushes)	15" - 2.88" CH	36P42A	N/A
KA-33 Dura-Scrub (2 brushes)	16" - 2.88" CH	36P42A	N/A
KA33BR (2 brushes)	16"	CALL*	CALL*
KA-33SS, KA-33SSA Select Scrub (2 brushes)	16" - 2.88" CH	36P42A	N/A
KA-34BR2 (rider) (2 brushes)	16"	CALL*	CALL*
KA-36 (2 brushes)	15" - 2.88" CH	36P42A	N/A
KA-38 (2 brushes)	18" - 2.88" CH	36P42A	N/A

**CALL\*** - Use the Rotary Wizard on the Carlisle website located in the Support section or call Customer Service at 800-654-8210.

**WARNING:** Do not use brushes, pads, or tools with flammable materials as serious bodily injury could result.



Machine Manufacturer's Model No	Block Dia	Suggested Carlisle Plate	Suggested EZ Snap Plate
KA-39 Dura-Scrub (2 brushes)	19" - 2.88" CH	36P42A	N/A
KA-39SS, KA-39SSA Select Scrub (2 brushes)	19" - 2.88" CH	36P42A	N/A
KA-170B, KA-171B	15"	364192P	364192BD
KA-260B (2 brushes)	12" - 2.88" CH	36P42A	N/A
KA-261, KA-262B, KA-265, KA-266EB, 26ERB2 (2 brushes)	13" - 2.88" CH	36P42A	N/A
KA-325B (2 brushes)	15" - 2.88" CH	36P42A	N/A
KA-326EB, 32ERB2, KA-36 (2 brushes)	15" - 2.88" CH	36P42A	N/A
KA-381EB, 38ERB2 (2 brushes)	18" - 2.88" CH	36P42A	N/A
KA-382 (2 brushes)	18" - 2.88" CH	36P42A	N/A
KA-3818 (2 brushes)	18" - 2.88" CH	36P42A	N/A
KF-13, KF-13DL, KF-13SL	11"	364192P	364192BD
KF-17, KF-17DL, KF-17SL, KF-17SL2	15"	364192P	364192BD
KF-17SL2 (2 speed)	15"	364192P	364192BD
KF-20, KF-20DL, KF-20HD, KF-20SL	18"	364192P	364192BD
KF-20SL2 (2 speed)	18"	364192P	364192BD
K-130, KF-130	11"	364192P	364192BD
KF-150A	13"	364192P	364192BD
K-170, KF-170A, KF-174SL, KF-175A	15"	364192P	364192BD
KF-175SA - high speed pad driver	15"	CALL*	CALL*
KF-176, KF-176SL2 (2 speed)	15"	364192P	364192BD
KF-195, KF-195M	18"	364192P	364192BD
KF-200A, KF-201, KF-202S, KF-204SL	18"	364192P	364192BD
KF204SC	18"	CALL*	CALL*
KF-205A, KF-205S2 (2 speed)	18"	364192P	364192BD
KF-206, KF-206SL (2 speed)	18"	364192P	364192BD
M-13, MA-13	11"	364192P	364192BD
M-15, MA-15, XP-15	13"	364192P	364192BD
M-17, MA-17, XP-17	15"	364192P	364192BD
M-20, MA-20, XP-20	18"	364192P	364192BD
NA-13	11"	364192P	364192BD
Razor 17	16"	364148P	364148BD
Razor 20, 20T	19"	364148P	364148BD
Razor 26, Razor Blade 26D (2 brushes)	13"	364148P	364148BD
Razor 28 (Razor Plus), Razor Blade 28D (2 brushes)	14"	364148P	364148BD
Razor Plus 24D (2 brushes)	12"	364148P	364148BD
SD130	11"	364192P	364192BD
Select Line 13	11"	364192P	364192BD
Select Line 17, 17HD	15"	364192P	364192BD

Machine Manufacturer's Model No	Block Dia	Suggested Carlisle Plate	Suggested EZ Snap Plate
Select Line 20, 20HD, 20TS (2 speed)	18"	364192P	364192BD
SV-17	16"	364148P	364148BD
<b>Koblenz</b>			
DP-1334	11"	364192P	364192BD
RM-1715	15"	364192P	364192BD
RM-2015	18"	364192P	364192BD
TP-1710, TP-1715	15"	364192P	364192BD
TP-2010, TP-2015	18"	364192P	364192BD
<b>Lawlor</b>			
15W, 16, 151, 151W	14" - 6" CH	N/A	N/A
19, 20D, 181, 181W	17" - 6" CH	N/A	N/A
221, 221R	20" - 6" CH	N/A	N/A
C-12, C-13	11"	364192P	364192BD
C-16, CF-16	14"	364192P	364192BD
C-19, CF-19	17"	364192P	364192BD
C-22, CF-22	20"	364192P	364192BD
K-13, L-1300	12"	364192P	364192BD
K-16, L-1600	14"	364192P	364192BD
K-19, L-1900	17"	364192P	364192BD
<b>Mastercraft</b>			
1300, 1330, 3300	11"	364192P	364192BD
1550, 1575, 2550	13"	364192P	364192BD
1700, 1775	15"	364192P	364192BD
1900, 3900, 3990	17"	364192P	364192BD
3550, 3575, 4500, 4550, 4575	13"	364192P	364192BD
3700, 3775, 4775	15"	364192P	364192BD
MBS-2000E - high speed pad driver	18"	CALL*	CALL*
MD-13A	11"	364192P	364192BD
MD-15B, MD-15C, MD-15D	13"	364192P	364192BD
MD-17, MD-17C, MD-17D, MH-17E, MTS-17E, MTXV-17E	15"	364192P	364192BD
MD-20, MD-20D, MD-20E, MH-20E, MTS-20E, MTSV-20E	18"	364192P	364192BD
MD-21	19"	364192P	364192BD
MHS20E - high speed pad driver	18"	CALL*	CALL*
PR-13B	11"	364192P	364192BD
PR-17D, PR-17E	15"	364192P	364192BD
PR-20E	18"	364192P	364192BD
<b>Mercury</b>			
13, BDP-13	11"	364192P	364192BD
14, BDP-14	12"	364192P	364192BD
15-1/2, BDP-15, BDP-15-1/2	13"	364192P	364192BD
16, BDP-16	14"	364192P	364192BD
17, BDP-17	15"	364192P	364192BD
19, BDP-19	17"	364192P	364192BD
21, BDP-21	19"	364192P	364192BD

**CALL\*** – Use the Rotary Wizard on the Carlisle website located in the Support section or call Customer Service at 800-654-8210.

**WARNING:** Do not use brushes, pads, or tools with flammable materials as serious bodily injury could result.

# ROTARY BRUSHES | MACHINE LISTINGS



Machine Manufacturer's Model No	Block Dia	Suggested Carlisle Plate	Suggested EZ Snap Plate
<b>Mercury (cont.)</b>			
BGM-17, DC-17, GM-17	16"	CALL*	CALL*
BGM-19, DC-19, GM-19	17"	CALL*	CALL*
DC-21, GM-21	20"	CALL*	CALL*
H-15, HSP-15, L-15, L-15-1/2	13"	364192P	364192BD
H-17, HSP-17	15"	364192P	364192BD
H-19, HSP-19	17"	364192P	364192BD
H-21, HSP-21	19"	364192P	364192BD
L-16, 16-SpeedMaster	14"	364192P	364192BD
L-17, TS-17, Timesaver 17	15"	364192P	364192BD
L-19, P-19, TS-19, Timesaver 19	17"	364192P	364192BD
L-21, TS-21, Timesaver 21	19"	364192P	364192BD
<b>National Super Service</b>			
2010 AB/AE	18"	364192P	364192BD
24B	12"	N/A	N/A
Champ ZS29, 2929 (2 brushes)	14" - 5.53" CH	36P74	36P74BD
Champ 3329 (2 brushes)	16" - 5.53" CH	36P74	36P74BD
Champ 3529 (2 brushes)	17" - 5.53" CH	36P74	36P74BD
Filly 13	11"	364192P	364192BD
Galaxy 17	15"	364192P	364192BD
Galaxy 20	18"	364192P	364192BD
Maverick II - 15	13"	364192P	364192BD
Maverick II - 17, Maverick 300-17	15"	364192P	364192BD
Maverick II - 20, Maverick 300-20	18"	364192P	364192BD
Maverick 300	18"	364192P	364192BD
Mustang 17, Mustang 300-17	15"	364192P	364192BD
Mustang 20, Mustang 300-20	18"	364192P	364192BD
Portable 13 (old style)	11"	N/A	N/A
Portable 13-SP	11"	364192P	364192BD
SS-13	11"	364192P	364192BD
SP-15, SS-15	13"	364192P	364192BD
SP-16, SS-16	14"	364192P	364192BD
SP-17, SS-17	15"	364192P	364192BD
SP-19, SS-19	17"	364192P	364192BD
SP-20, SS-20	18"	364192P	364192BD
Thoroughbred FP15	13"	364192P	364192BD
Thoroughbred 17	15"	364192P	364192BD
Thoroughbred 20	18"	364192P	364192BD
Wrangler 17	15"	364192P	364192BD
Wrangler 20	18"	364192P	364192BD
Wrangler 24 (2 brushes)	11" - 5.53" CH	36P74	36P74BD
Wrangler 26 (2 brushes)	12" - 5.53" CH	36P74	36P74BD

Machine Manufacturer's Model No	Block Dia	Suggested Carlisle Plate	Suggested EZ Snap Plate
Wrangler 27, 2625DB (2 brushes)	13" - 5.53" CH	36P74	36P74BD
Wrangler 33, 3329 (2 brushes)	16" - 5.53" CH	36P74	36P74BD
Wrangler 1708C	17"	364192P	364192BD
Wrangler 2008C	20"	364192P	364192BD
Wrangler 2010 AB/AE	18"	364192P	364192BD
Wrangler 2016DB	18"	364192P	364192BD
<b>Nilfisk-Advance (Advance)</b>			
130, 135	11"	364147P	364200BD & 364147P
150, 155	13"	364147P	364200BD & 364147P
17A, 170, 175	15"	364147P	364200BD & 364147P
17B	15"	364192P	364192BD
200	18"	364147P	364200BD & 364147P
220, 225	20"	364147P	364200BD & 364147P
Adfinity 17ST	16"	364148P	364148BD
Adfinity 20ST, 20, X20D, X20C, 20D	19"	364148P	364148BD
Adfinity 24 (2 brushes)	11"	364148P	364148BD
Adgressor 28 (2 brushes)	13" - 5.53" CH	36P74	36P74BD
Adgressor 32, 3220 (2 brushes)	15" - 5.53" CH	36P74	36P74BD
Adgressor 35, 3520 (3 brushes)	11" - 5.53" CH	36P74	36P74BD
Adgressor 38, 3820 (3 brushes)	12" - 5.53" CH	36P74	36P74BD
Advenger 2400D (2 brushes)	11" - 5.53" CH	36P74	36P74BD
Advenger 2600D (2 brushes)	12" - 5.53" CH	36P74	36P74BD
Advenger 2810D (2 brushes)	13" - 5.53" CH	36P74	36P74BD
Advenger 3210D (2 brushes)	15" - 5.53" CH	36P74	36P74BD
Advenger 3400ST (2 brushes)	16" - 5.53" CH	36P74	36P74BD
All Purpose Matador 17	15"	364147P	364200BD & 364147P
All Purpose Matador 20	18"	364147P	364200BD & 364147P
BA 5321, BA 5321D	19"	364148P	364148BD
BR651, BR652	12"	364148P	364148BD
Captor 4300 (3 brushes)	14" - 5.53" CH	36P74	36P74BD
Captor 4800 (3 brushes)	16" - 5.53" CH	36P74	36P74BD
Captor 5400 (4 brushes)	13" - 5.53" CH	36P74	36P74BD
Centurian 17	15"	364147P	364200BD & 364147P
Centurian 20	18"	364147P	364200BD & 364147P
Centurian 150	13"	364147P	364200BD & 364147P
Converta Max 20	19"	364148P	364148BD
Converta Max 26 (2 brushes)	12" - 5.53" CH	36P74	36P74BD
Converta Max 28 (2 brushes)	14" - 5.53" CH	36P74	36P74BD

**CALL\*** - Use the Rotary Wizard on the Carlisle website located in the Support section or call Customer Service at 800-654-8210.

**WARNING:** Do not use brushes, pads, or tools with flammable materials as serious bodily injury could result.



Machine Manufacturer's Model No	Block Dia	Suggested Carlisle Plate	Suggested EZ Snap Plate
Converta Max 34 (2 brushes)	16" - 5.53" CH	36P74	36P74BD
Convertamatic 17	15"	364147P	364200BD & 364147P
Convertamatic 18	16" - 5.53" CH	36P74	36P74BD
Convertamatic 20	18"	364147P	364200BD & 364147P
Convertamatic 21	19" - 5.53" CH	36P74	36P74BD
Convertamatic 24 (2 brushes)	11" - 5.53" CH	36P74	36P74BD
Convertamatic 26 (2 brushes)	12" - 5.53" CH	36P74	36P74BD
Convertamatic 28 (2 brushes)	14" - 5.53" CH	36P74	36P74BD
Convertamatic 32 (2 brushes)	16" - 5.53" CH	36P74	36P74BD
Convertamatic 38 (2 brushes)	19" - 5.53" CH	36P74	36P74BD
Convertamatic 200	18"	364147P	364200BD & 364147P
Convertamatic 240 (2 brushes)	11" - 5.53" CH	36P74	36P74BD
Convertamatic 260, 265, 265LX (2 brushes)	12" - 5.53" CH	36P74	36P74BD
Convertamatic 280, 285 (2 brushes)	14" - 5.53" CH	36P74	36P74BD
Convertamatic 320, 325 (2 brushes)	16" - 5.53" CH	36P74	36P74BD
Convertamatic 380, 385, 3800 (2 brushes)	19" - 5.53" CH	36P74	36P74BD
Convertamatic TRAC 5000B (4 brushes)	12" - 5.53" CH	36P74	36P74BD
CS7000 (3 brushes)	16" - 5.53" CH	36P74	36P74BD
G2000	18"	364147P	364200BD & 364147P
Galaxie 14 (new)	12" - 4.91" CH	N/A	N/A
Galaxie 16 (new)	14" - 4.91" CH	N/A	N/A
Galaxie 16, 160, G1600	14"	364147P	364200BD & 364147P
Galaxie 18 (new)	16" - 5" CH	N/A	N/A
Galaxie 18, 180	16"	364147P	364200BD & 364147P
Galaxie 20	18"	364147P	364200BD & 364147P
Gyro 13	11"	364147P	364200BD & 364147P
Gyro 14, 11-14	12"	364147P	364200BD & 364147P
Hydro-Cat (2 brushes)	12" - 5.53" CH	36P74	36P74BD
Hydro-Cat 5015 (4 brushes)	12" - 5.53" CH	36P74	36P74BD
Hydro-Retriever 200	18"	364147P	364200BD & 364147P
Hydro-Retriever 240 (2 brushes)	11" - 5.53" CH	36P74	36P74BD
Hydro-Retriever 2800 (2 brushes)	14" - 5.53" CH	36P74	36P74BD
Hydro-Retriever 3200 (2 brushes)	16" - 5.53" CH	36P74	36P74BD
Hydro-Retriever 3800 (2 brushes)	19" - 5.53" CH	36P74	36P74BD
Lynx 285 (2 brushes)	14" - 5.53" CH	36P74	36P74BD
Lynx 325 (2 brushes)	16" - 5.53" CH	36P74	36P74BD
Lynx 385 (2 brushes)	19" - 5.53" CH	36P74	36P74BD

Machine Manufacturer's Model No	Block Dia	Suggested Carlisle Plate	Suggested EZ Snap Plate
MP-20 HS	18"	364147P	364200BD & 364147P
Matador 17	15"	364147P	364200BD & 364147P
Matador 20	18"	364147P	364200BD & 364147P
Micromatic 14E	12"	364192P	364192BD
Micromatic 17B	15"	364148P	364148BD
Micromax 17B, 17E	16"	364148P	364148BD
Micromax 20B, 20DD	19"	364148P	364148BD
Mobilmatic 17	15"	364147P	364200BD & 364147P
Mobilmatic 20	18"	364147P	364200BD & 364147P
Mobilmatic 64, 6400 (4 brushes)	15" - 5.53" CH	36P74	36P74BD
Pacemaker 15	13"	364147P	364200BD & 364147P
Pacemaker 17	15"	364147P	364200BD & 364147P
Pacemaker 20, P20E	18"	364147P	364200BD & 364147P
Pacemaker 22	20"	364147P	364200BD & 364147P
Pacesetter 13	11"	364192P	364192BD
Pacesetter 17, 17HD	15"	364192P	364192BD
Pacesetter 20, 20HD, 20TS, 20SD	18"	364192P	364192BD
PM1000	15"	364147P	364200BD & 364147P
SC350, SC351	14"	364148P	364148BD
SC400-17B	15"	364192P	364192BD
SC450	18"	364148P	364148BD
SC750-26D (2 brushes)	12" - 5.53" CH	36P74	36P74BD
SC750-28D (2 brushes)	14" - 5.53" CH	36P74	36P74BD
SC800-34D, SC800 ST-34D (2 brushes)	16" - 5.53" CH	36P74	36P74BD
SC800-28D (2 brushes)	14" - 5.53" CH	36P74	36P74BD
SC1500 (2 brushes)	19" - 5.53" CH	36P74	36P74BD
SC3000-26D (2 brushes)	12"	364148P	364148BD
SD 17, SD 4317	15"	364192P	364192BD
SD 20, SD 5120	18"	364192P	364192BD
SD130	11"	364192P	364192BD
Shadow 17	15"	364192P	364192BD
Shadow 20	18"	364192P	364192BD
Speedboy Special 15	13"	364147P	364200BD & 364147P
Spin 17	15"	364192P	364192BD
Spin 20	18"	364192P	364192BD
Trac 240 (2 brushes)	11" - 5.53" CH	36P74	36P74BD
Trac 280, 2800 (2 brushes)	14" - 5.53" CH	36P74	36P74BD
Trac 320 (2 brushes)	16" - 5.53" CH	36P74	36P74BD
Trac 380 (2 brushes)	19" - 5.53" CH	36P74	36P74BD
Warrior 28D (2 brushes)	13" - 5.53" CH	36P74	36P74BD

**CALL\*** – Use the Rotary Wizard on the Carlisle website located in the Support section or call Customer Service at 800-654-8210.

**WARNING:** Do not use brushes, pads, or tools with flammable materials as serious bodily injury could result.

# ROTARY BRUSHES | MACHINE LISTINGS



Machine Manufacturer's Model No	Block Dia	Suggested Carlisle Plate	Suggested EZ Snap Plate	Machine Manufacturer's Model No	Block Dia	Suggested Carlisle Plate	Suggested EZ Snap Plate
<b>Nilfisk-Advance (Advance) (cont.)</b>				PS-20	18"	364192P	364192BD
Warrior 32D (2 brushes)	15" - 5.53" CH	36P74	36P74BD	PS-22	20"	364192P	364192BD
Warrior 34, 34RST (2 brushes)	17"	CALL*	CALL*	Speed Scrub 20	18"	364192P	364192BD
Whirlamatic 180	16" - 5.53" CH	36P74	36P74BD	Speed Scrub 24, SS5-24 (2 brushes)	11"	364109	364108BD
Whirlamatic 200, 205	18"	364147P	364200BD & 364147P	Speed Scrub 28, SS5-28 (2 brushes)	13"	364109	364108BD
Whirlamatic 210, 215	19" - 5.53" CH	36P74	36P74BD	Speed Scrub 32, SS5-32 (2 brushes)	15"	364109	364108BD
Whirlamatic 240, 245 (2 brushes)	11" - 5.53" CH	36P74	36P74BD	Speedshine 2000-17	15"	364192P	364192BD
Whirlamatic 260 (2 brushes)	12" - 5.53" CH	36P74	36P74BD	SS-14, SPR-14	12"	364192P	364192BD
Whirlamatic 320, 325 (2 brushes)	15" - 5.53" CH	36P74	36P74BD	SS-16, SPR-16	14"	364192P	364192BD
Whirlamatic 1100 - high speed pad driver	18"	CALL*	CALL*	SS-17, SPR-17	15"	364192P	364192BD
Whisper 17	15"	364147P	364200BD & 364147P	SS-170, SS-1701, SS-1700	15" - 5.53" CH	36P74	36P74BD
Whisper 20	18"	364147P	364200BD & 364147P	SS-1701 Plus	15"	364115	364200BD & 364115
Wildcat 15	13"	364147P	364200BD & 364147P	SS-19, SPR-19	17"	364192P	364192BD
Wildcat 16	14"	364147P	364200BD & 364147P	SS-20, SPR-20, SS2000DS, Speedshine 2000-20	18"	364192P	364192BD
Wildcat 17	15"	364147P	364200BD & 364147P	SS-22, SPR-22	20"	364192P	364192BD
Wildcat 20	18"	364147P	364200BD & 364147P	SS-24 (2 brushes)	11"	364108	364108BD
Wildcat 22	20"	364147P	364200BD & 364147P	SS-27 (2 brushes)	13" - 5.53" CH	36P74	36P74BD
Wizard 13	11"	364147P	364200BD & 364147P	SS-33 (2 brushes)	16" - 5.53" CH	36P74	36P74BD
Wolverine 20	18"	364147P	364200BD & 364147P	SS-2000, SS-2001	19" - 5.53" CH	36P74	36P74BD
<b>Nobles</b>				SS-2000DS	18"	364192P	364192BD
20 Series	18"	364192P	364192BD	SS-2200	19" - 5.53" CH	36P74	36P74BD
24 (2 brushes)	12" - 4" CH	N/A	N/A	SS-2400, SS-2401 (2 brushes)	11" - 5.53" CH	36P74	36P74BD
32 (2 brushes)	15" - 4" CH	N/A	N/A	SS-2601 (2 brushes)	12" - 5.53" CH	36P74	36P74BD
260 (2 brushes)	13"	CALL*	CALL*	SS-2700, SS-2701, SS-2800 (2 brushes)	13" - 5.53" CH	36P74	36P74BD
265XP (2 brushes)	12"	364109	364108BD	SS-3300, SS-3301 (2 brushes)	16" - 5.53" CH	36P74	36P74BD
320 (2 brushes)	15"	CALL*	CALL*	SS-5300	19"	CALL*	CALL*
1400 Series	12"	364192P	364192BD	SS3-17	16"	364174	36P74BD
1700 Series	15"	364192P	364192BD	SS3-20	19"	364174	36P74BD
2000 Series	18"	364192P	364192BD	Tuff Scrub 3300 (2 brushes)	16" - 5.53" CH	36P74	36P74BD
5300	19"	CALL*	CALL*	WB 20	18"	364192P	364192BD
EZ Rider HP28 (2 brushes)	14"	364108	364108BD	<b>North American/Nacecare</b>			
EZ Rider HP32 (2 brushes)	16"	364108	364108BD	TTB516	15"	364101E	364200BD & 364101E
FM-17-SS	15"	364192P	364192BD	TTB 665/200s (2 brushes)	12"	364101E	364200BD & 364101E
FM-20-SS	18"	364192P	364192BD	TT455s	20"	364101E	364200BD & 364101E
FS-2000	19" - 5.53" CH	36P74	36P74BD	TT4550	20"	364101E	364200BD & 364101E
PS-14	12"	364192P	364192BD	Twintec 345, TT-345	16"	364101E	364200BD & 364101E
PS-16	14"	364192P	364192BD	TTB 455-100s (2 brushes)	11"	364101E	364200BD & 364101E
PS-17	15"	364192P	364192BD	<b>NuSource</b>			
PS-19	17"	364192P	364192BD	NU-17FLC, NU-17FLHD, NU-17FLDS	15"	364192P	364192BD
				NU-20FLC, NU-20FLHD, NU-20FLDS	18"	364192P	364192BD

**CALL\*** – Use the Rotary Wizard on the Carlisle website located in the Support section or call Customer Service at 800-654-8210.

**WARNING:** Do not use brushes, pads, or tools with flammable materials as serious bodily injury could result.



Machine Manufacturer's Model No	Block Dia	Suggested Carlisle Plate	Suggested EZ Snap Plate
<b>Pacific</b>			
13, Satellite 13	11"	364192P	364192BD
14	12"	364192P	364192BD
15	13"	364192P	364192BD
16, Satellite 16	14"	364192P	364192BD
17	15"	364192P	364192BD
19, 19A	17"	364192P	364192BD
21	19"	364192P	364192BD
22, P22G	20"	364192P	364192BD
FM-17	15"	364192P	364192BD
FM-20	18"	364192P	364192BD
Fury 1500 DCP	13"	CALL*	CALL*
Fury 2000 DCP	18"	CALL*	CALL*
HS-17	15"	364192P	364192BD
HS-19	17"	364192P	364192BD
HS-20DC	18"	364192P	364192BD
PCP-13	11"	364192P	364192BD
PCP-15	13"	364192P	364192BD
PCP-17, PHS-17	15"	364192P	364192BD
PCP-20, PHS-20DC, P-20, PS-20	18"	364192P	364192BD
PHS-19	17"	364192P	364192BD
PS-20	18"	364192P	364192BD
Searay 133	11"	364192P	364192BD
Searay 175, 175DS, 175 HD	15"	364192P	364192BD
Searay 205, 205DS	18"	364192P	364192BD
VS-20	18"	364192P	364192BD
<b>Ponsell Atlas</b>			
A-15	13" - 5" CH	N/A	N/A
CR-134	11"	N/A	N/A
CR-154, CR-155, CR156	13"	N/A	N/A
CR-175, CR-176, CR-177	15"	N/A	N/A
CR-196, CR197	17"	N/A	N/A
CR-206, CR-207	18"	N/A	N/A
CR-226, CR-227	20"	N/A	N/A
DS-14, E-15, G-15, H-15	13" - 5" CH	N/A	N/A
DS-16, I-16	14" - 5" CH	N/A	N/A
DS-19, I-19, O-19	17" - 5" CH	N/A	N/A
Q-12, Q-13	12" - 5" CH	N/A	N/A
Q-15, QS-15	13" - 5" CH	N/A	N/A
Q-16, QS-16	14" - 5" CH	N/A	N/A
Q-18	16" - 5" CH	N/A	N/A
Q-19	17" - 5" CH	N/A	N/A
V-16, VS-16	14" - 5" CH	N/A	N/A
V-19, VS-19	17" - 5" CH	N/A	N/A
V-22	20" - 5" CH	N/A	N/A

Machine Manufacturer's Model No	Block Dia	Suggested Carlisle Plate	Suggested EZ Snap Plate
<b>Powr-Flite</b>			
C171, C171HD, C171SD, C172, M171-3, M171HD-3, M172-3	15"	364192P	364192BD
C201, C201HD, C202, M201-3, M201HD-3, M202-3	18"	364192P	364192BD
P131-3	11"	364192P	364192BD
PAS17	16"	364192P	364192BD
<b>Pullman-Holt (Boss Cleaning)</b>			
50	14"	364192P	364192BD
2S-16	14" - 5" CH	N/A	N/A
2S-17	15" - 5" CH	N/A	N/A
2S-20	18" - 5" CH	N/A	N/A
A-14	12" - 5" CH	N/A	N/A
A-16	14" - 5" CH	N/A	N/A
B-13 Series	11"	364192P	364192BD
B-14 Series	12"	364192P	364192BD
B-16 Series	14"	364192P	364192BD
B-18 Series	16"	364192P	364192BD
B-20 Series	18"	364192P	364192BD
B-22F	20"	364192P	364192BD
C-16D, C-16E	14"	364192P	364192BD
C-18 Series	16"	364192P	364192BD
C-20 Series	18"	364192P	364192BD
C-22F	20"	364192P	364192BD
CD-14	12" - 5" CH	N/A	N/A
CD-16	14" - 5" CH	N/A	N/A
D-18F	16"	364192P	364192BD
DS-20F	18"	364192P	364192BD
ES2000	18"	364192P	364192BD
Expert-13	11"	364192P	364192BD
Expert-16	14"	364192P	364192BD
Expert-18	16"	364192P	364192BD
Expert-20	17"	364192P	364192BD
Expert-22	20"	364192P	364192BD
Gloss Boss 1090, 1500, 2000 - high speed pad driver	18"	CALL*	CALL*
Heavy-Duty 15	13" - 4.25" CH	N/A	N/A
HS18F	16"	364192P	364192BD
J-13, JW-13	11"	364192P	364192BD
JW-16	14"	364192P	364192BD
JW-18	16"	364192P	364192BD
JW-20	17"	364192P	364192BD
JW-22	20"	364192P	364192BD
M-13-1/2	11"	364183P	364200BD & 364183P
M-15-1/2	13"	364183P	364200BD & 364183P
M-16 Series	14"	364192P	364192BD

**CALL\*** – Use the Rotary Wizard on the Carlisle website located in the Support section or call Customer Service at 800-654-8210.

**WARNING:** Do not use brushes, pads, or tools with flammable materials as serious bodily injury could result.

# ROTARY BRUSHES | MACHINE LISTINGS



Machine Manufacturer's Model No	Block Dia	Suggested Carlisle Plate	Suggested EZ Snap Plate
<b>Pullman-Holt (Boss Cleaning) (cont.)</b>			
M-17	15"	364183P	364200BD & 364183P
M-18 Series	16"	364192P	364192BD
M-20 Series	18"	364192P	364192BD
P-12-1/2	11"	364192P	364192BD
P-13B, P-13C	11"	364192P	364192BD
P-14, PC-14, PR-14	12"	364192P	364192BD
P-16, PC-16, PR-16, PX-16	14"	364192P	364192BD
P-18, PC-18, PR-18	16"	364192P	364192BD
P-20 Series, PC-20, PR-20, PX-20, PES-2000	18"	364192P	364192BD
P-22 Series, PC-22 Series	20"	364192P	364192BD
S-17 Series	15"	364192P	364192BD
S-20 Series	18"	364192P	364192BD
Scrub Boss SB26 (2 brushes)	12" - 5.13" CH	N/A	N/A
Scrub Boss SB32 (2 brushes)	15" - 5.13" CH	N/A	N/A
Single 13	11"	364192P	364192BD
Single 14	12"	364192P	364192BD
Single 16	14"	364192P	364192BD
Single 18, Single 19	16"	364192P	364192BD
Single 20	17"	364192P	364192BD
Single 22	20"	364192P	364192BD
Special 16	14"	364192P	364192BD
Special 20E	18"	364192P	364192BD
Super 16	14"	364192P	364192BD

### RPS (Factory Cat/Tomcat)

See Factory Cat/Tomcat on pages 134-135.

### Standardized Sanitation Systems (SSS)

15	13"	364192P	364192BD
16	14"	364192P	364192BD
17, 17VS, 17HS	15"	364192P	364192BD
19, 19A	17"	364192P	364192BD
21, 21VS, 20HS	19"	364192P	364192BD
Cougar 17	15"	364192P	364192BD
Cougar 20	18"	364192P	364192BD
Panther 18C	17" - 5.53" CH	36P74	36P74BD
Panther 20T	19" - 5.53" CH	36P74	36P74BD

### Taski

Hi-Speed	15"	CALL*	CALL*
Combimat 55 (2 brushes)	11" - 4" CH	N/A	N/A
Except Scrub-Grit® II & Dyna-Scrub®	12" - 4" CH	N/A	N/A
Combimat 85 (2 brushes)	16" - 4" CH	N/A	N/A
Except Scrub-Grit® II & Dyna-Scrub®	17" - 4" CH	N/A	N/A

Machine Manufacturer's Model No	Block Dia	Suggested Carlisle Plate	Suggested EZ Snap Plate
1000E	19" - 4" CH	N/A	N/A
Combimat 1500 (2 brushes)	11"	CALL*	CALL*
Combimat 1700 (2 brushes)	14"	CALL*	CALL*
Combimat 1900 (2 brushes)	17"	CALL*	CALL*
<b>Tennant (Tennant Trend)</b>			
426 (2 brushes)	12" - 4.36" CH	N/A	N/A
432 (2 brushes)	16" - 5.5" CH	N/A	N/A
465, 1465 (2 brushes)	12"	364108	364108BD
480, 1480 (2 brushes)	16"	364108	364108BD
490, 1490 (2 brushes)	18"	364108	364108BD
510E, 515, 7300, 8010, 8200, 8210, 8300, Max Pro 1000 (2 brushes)	20"	364108	364108BD
515, 7300, 7400, 8010, 8200, 8210, 8300, Max Pro 1200 (3 brushes)	16"	364108	364108BD
528, 530E	12"	364108	364108BD
2000	15"	364192P	364192BD
2030-17	15"	364192P	364192BD
2030-20	18"	364192P	364192BD
2040	18"	364192P	364192BD
2100	11"	364192P	364192BD
2100-17	15"	364192P	364192BD
2100-20	18"	364192P	364192BD
2120, 2140, 2160	15"	364192P	364192BD
2130, 2150, 2170	18"	364192P	364192BD
2270-17	15"	364192P	364192BD
2270-20	18"	364192P	364192BD
5100	15"	364115	364200BD & 364115
5200	19" - 5.53" CH	36P74	36P74BD
5280, 5300	19" - 5.53" CH	CALL*	CALL*
5400-24D (2 brushes)	11" - 5.53" CH	364109	364108BD
5400-26D (2 brushes)	12" - 5.53" CH	364109	364108BD
5500 (2 brushes)	11" - 5.53" CH	36P74	36P74BD
5520 (2 brushes)	12" - 5.53" CH	36P74	36P74BD
5540 (2 brushes)	13" - 5.53" CH	36P74	36P74BD
5560 (2 brushes)	16" - 5.53" CH	36P74	36P74BD
5680-700D, 5700-700D, 7100-28D, 7200 Tight Aisle (2 brushes)	14"	364108	364108BD
5680-800D, 5700-800D, 7100-32D (2 brushes)	16"	364108	364108BD
5680-900D, 5700-900D, 7200D (2 brushes)	18"	364108	364108BD
7080-28 (2 brushes)	14"	364108	364108BD
7080-32 (2 brushes)	16"	364108	364108BD

**CALL\*** – Use the Rotary Wizard on the Carlisle website located in the Support section or call Customer Service at 800-654-8210.

**WARNING:** Do not use brushes, pads, or tools with flammable materials as serious bodily injury could result.





Machine Manufacturer's Model No	Block Dia	Suggested Carlisle Plate	Suggested EZ Snap Plate
8400, 8410, Max Pro 1200 (3 brushes)	16"	364108	364108BD
AS265XP/TX (2 brushes)	13"	364109	364108BD
BA-2000	19" - 5.53" CH	36P74	36P74BD
EZ Rider-28 (2 brushes)	14"	364108	364108BD
EZ Rider-32 (2 brushes)	16"	364108	364108BD
F5-17, F10-17	15"	364192P	364192BD
F5-20, F10-20	18"	364192P	364192BD
FM-17-SS	15"	364192P	364192BD
FM-20-SS, FM-20-DS	18"	364192P	364192BD
FS-2000	19" - 5.53" CH	36P74	36P74BD
M-20	16"	364108	364108BD
Powerline 17	15"	CALL*	CALL*
Powerline 20	18"	CALL*	CALL*
Power Trend 15	14"	364192P	364192BD
Power Trend 17	16"	364192P	364192BD
Power Trend 20	19"	364192P	364192BD
S250 (2 brushes)	12" - 5.53" CH	36P74	36P74BD
Speed Scrub 1701 Plus	15"	364115	364200BD & 364115
Servomatic 17	15" - 4.94" CH	N/A	N/A
Servomatic 26, 261 (2 brushes) Except Scrub-Grit® II & Dyna-Scrub®	12" - 4.36" CH	N/A	N/A
Servomatic 32 (2 brushes)	15" - 4.36" CH	N/A	N/A
SS5-28 (2 brushes)	13"	364109	364108BD
SS5-32 (2 brushes)	15"	364109	364108BD
SSR-26D (2 brushes)	13"	364109	364108BD
SSR-32D (2 brushes)	16"	364109	364108BD
T2-17	16"	364174	36P74BD
T2-20	19"	364174	36P74BD
T3-17	16"	364174	36P74BD
T3-20	19"	364174	36P74BD
T5-24 (2 brushes)	11"	364109	364108BD
T5-28 (2 brushes)	13"	364109	364108BD
T5-32 (2 brushes)	15"	364109	364108BD
T7-26 (2 brushes)	13"	364109	364108BD
T7-32 (2 brushes)	16"	364109	364108BD
T12 (2 brushes)	16"	364108	364108BD
T15 (2 brushes)	18"	364108	364108BD
T16 (2 brushes)	18"	364108	364108BD
T20 (3 brushes)	14"	364108	364108BD
Viking 15	14"	N/A	N/A

**Tennant Trend (Tennant)**

See Tennant (Tennant Trend) listing on pages 142-143.

Machine Manufacturer's Model No	Block Dia	Suggested Carlisle Plate	Suggested EZ Snap Plate
<b>Thoro-Matic</b>			
SE 15	13"	364192P	364192BD
SE 17	15"	364192P	364192BD
SE 20	18"	364192P	364192BD
SE 22	20"	364192P	364192BD
TM 13	11"	364192P	364192BD
TM 15	13"	364192P	364192BD
TM 17, TM 17-TS	15"	364192P	364192BD
TM 20, TM 20 TS (2 speed)	18"	364192P	364192BD
TM 22	20"	364192P	364192BD
TM 300-17	15"	364192P	364192BD
TM 300-20 (2 speed)	18"	364192P	364192BD
TM-1000	18"	364192P	364192BD
<b>Tornado (Breuer)</b>			
15	13"	364192P	364192BD
17	15"	364192P	364192BD
17-1	16"	364192P	364192BD
19	17"	364192P	364192BD
20-1	18"	364192P	364192BD
22	20"	364192P	364192BD
73 Series	12" - 5" CH	N/A	N/A
75 Series	14" - 5" CH	N/A	N/A
77 Series	16" - 5" CH	N/A	N/A
94 Series	12"	364192P	364192BD
96, 97	14"	364192P	364192BD
98	16"	364192P	364192BD
130, 131, 132	11" - 4" CH	N/A	N/A
150	13"	364192P	364192BD
280-15, 283-15	13"	364192P	364192BD
280-17, 283-17	15"	364192P	364192BD
280-19, 283-19	17"	364192P	364192BD
280-22, 283-22	20"	364192P	364192BD
940 Series, 941	12"	364192P	364192BD
960, 961, 962	14"	364192P	364192BD
980, 981	16"	364192P	364192BD
990	20"	364192P	364192BD
3500 Floorkeeper (2 brushes)	15"	364103	364200BD & 364103
6400, 6500	12" - 5" CH	N/A	N/A
6600, 6700	14" - 5" CH	N/A	N/A
6800, 6900	16" - 5" CH	N/A	N/A
95625 (21" Auto-Mite)	19" - 4.63" CH	N/A	N/A

**CALL\*** – Use the Rotary Wizard on the Carlisle website located in the Support section or call Customer Service at 800-654-8210.

**WARNING:** Do not use brushes, pads, or tools with flammable materials as serious bodily injury could result.

# ROTARY BRUSHES | MACHINE LISTINGS



Machine Manufacturer's Model No	Block Dia	Suggested Carlisle Plate	Suggested EZ Snap Plate
<b>Tornado (Breuer) (cont.)</b>			
95678/95679 (16" Auto-Mite)	14" - 4.63" CH	N/A	N/A
97580 (M17-175)	15"	364192P	364192BD
97585 (M20-175)	18"	364192P	364192BD
97800 (16" Series I)	14"	364192P	364192BD
97805 (18" Series I)	16"	364192P	364192BD
97810 (20" Series I)	18"	364192P	364192BD
97820 (14" Series I)	12"	364192P	364192BD
98400	13"	364192P	364192BD
98405 (17" Series II)	15"	364192P	364192BD
98410 (19" Series II)	17"	364192P	364192BD
98415 (22" Series II)	20"	364192P	364192BD
98470 (16" Bi-Speed)	14"	364192P	364192BD
98473 (17" Bi-Speed)	15"	364192P	364192BD
98480 (20" Bi-Speed)	18"	364192P	364192BD
98663 (Tri-Drive 1517)	15"	364192P	364192BD
98666 (Tri-Drive 1520)	18"	364192P	364192BD
98672 (17" ES Deluxe)	15"	364192P	364192BD
98673 (ES8673 - 17" Deluxe)	15"	364192P	364192BD
98674 (20" ES Deluxe)	18"	364192P	364192BD
98675 (ES8675 - 20" Deluxe)	18"	364192P	364192BD
98677 (1517SSM)	15"	364192P	364192BD
98682 (ES8682 - 17" Standard)	15"	364192P	364192BD
98683 (ES8683 - 17" Standard)	15"	364192P	364192BD
98684 (ES8684 - 20" Standard)	18"	364192P	364192BD
98685 (ES8685 - 20" Standard)	18"	364192P	364192BD
99125, 99105 (EZ-20 Floorkeeper)	19"	364192P	364192BD
99300 (Floorkeeper 3800) (2 brushes)	11"	364103	364200BD & 364103
99307 (26" Floorkeeper) (2 brushes)	14"	364103	364200BD & 364103
99321 (24" Floorkeeper) (2 brushes)	12"	364103	364200BD & 364103
99333 (32" - 2 brushes)	16"	364103	364200BD & 364103
99351 (28" Floorkeeper) (2 brushes)	14"	364103	364200BD & 364103
99407 (33" Mid-Range Floorkeeper) (2 brushes)	16"	364103	364200BD & 364103
99421 (32" Long-Range Floorkeeper) (2 brushes)	16"	364103	364200BD & 364103

Machine Manufacturer's Model No	Block Dia	Suggested Carlisle Plate	Suggested EZ Snap Plate
99430 (30" Floorkeeper) (2 brushes)	16"	364108	364108BD
99450, 99451 (36" Long-Range Floorkeeper) (2 brushes)	18"	364103	364200BD & 364103
99720 (BD 26/14) (2 brushes)	12" - 5.53" CH	36P74	36P74BD
Cyclone 14-1/2	12"	364192P	364192BD
Cyclone 16-1	14"	364192P	364192BD
Cyclone 18-1	16"	364192P	364192BD
Cyclone 19-1	17"	364192P	364192BD
Jumbo	14" - 6.13" CH	N/A	N/A
Majestic	18" - 6.13" CH	N/A	N/A
P17 (97562, 97563)	15"	364192P	364192BD
P20 (97564, 97565)	18"	364192P	364192BD
Royal	12" - 5.25" CH	N/A	N/A
Standard	16" - 6.13" CH	N/A	N/A
Thrifty 150	13"	364192P	364192BD
<b>Tundra</b>			
T13 Pro	11"	364192P	364192BD
T17 Pro, T17 Heavy, T17 Super Heavy, TL17	15"	364192P	364192BD
T20, T20 Heavy, T20 Super Heavy, T20 Dual, TL 20	18"	364192P	364192BD
<b>United (Unico)</b>			
CSU-13	11"	364192P	364192BD
CSU-14	12"	364192P	364192BD
CSU-15	13"	364192P	364192BD
CSU-16	14"	364192P	364192BD
CSU-17	15"	364192P	364192BD
CSU-20	18"	364192P	364192BD
P60-15	13"	364192P	364192BD
P60-17	15"	364192P	364192BD
P60-20	18"	364192P	364192BD
SBU-13	11"	364192P	364192BD
SBU-14	12"	364192P	364192BD
SBU-15, S60-16	13"	364192P	364192BD
SBU-16	14"	364192P	364192BD
SBU-17, S60-17	15"	364192P	364192BD
SBU-20, S60-20	18"	364192P	364192BD
SBU-20SS - high speed pad driver	18"	CALL*	CALL*
<b>Viper</b>			
DR17125, DR17175	15"	364192P	364192BD
DR20125, DR20175	18"	364192P	364192BD
Fang 15B	13"	364192P	364192BD

**CALL\*** – Use the Rotary Wizard on the Carlisle website located in the Support section or call Customer Service at 800-654-8210.

**WARNING:** Do not use brushes, pads, or tools with flammable materials as serious bodily injury could result.



Machine Manufacturer's Model No	Block Dia	Suggested Carlisle Plate	Suggested EZ Snap Plate
Fang 18	17"	CALL*	CALL*
Fang 20, 20T, 20HD	18" - 5.53" CH	36P74	36P74BD
Fang 24T (2 brushes)	11" - 5.53" CH	36P74	36P74BD
Fang 26T (2 brushes)	12" - 5.53" CH	36P74	36P74BD
Fang 28T (2 brushes)	13" - 5.53" CH	36P74	36P74BD
Fang 32T (2 brushes)	15" - 5.53" CH	36P74	36P74BD
TP2015HD	19"	364192P	364192BD
VN1700, VN1715	15"	364192P	364192BD
†VN1720P - 17", VN1720-17"	15"	364192P	364192BD
†VN1720P - 20", VN1720-20"	18"	364192P	364192BD
VN2015, VN20DS	18"	364192P	364192BD

† Model VN1720P is sold by the manufacturer with both a 17" and 20" deck.

**Windsor**

Chariot 2, iScrub 20, CS20	18"	364112	364112BD
Chariot 3, iScrub 26, CS26 (2 brushes)	12"	364112	364112BD
Chariot 20	19"	364112	364112BD
Chariot CSX24 (2 brushes)	12"	364112	364112BD
Lightning 175-17	15"	364183P	364200BD & 364183P
Lightning 175-20	18"	364183P	364200BD & 364183P
Merit 175-17 (MD-17)	15"	364183P	364200BD & 364183P
Merit 175-20 (MD-20)	18"	364183P	364200BD & 364183P
Merit MP13	11"	364192P	364192BD
Merit MP15	13"	364192P	364192BD
Merit MP17X	15"	364192P	364192BD
Merit MP20X	18"	364192P	364192BD
P 175-18	16"	364192P	364192BD
P 300-18, P360-18	16"	364192P	364192BD
P 300-20, P360-20	18"	364192P	364192BD
PA-18, PG-18	16"	364192P	364192BD
PowerTec 17	16"	CALL*	CALL*
PowerTec 20	18"	CALL*	CALL*
PowerTec 26 (2 brushes)	13"	CALL*	CALL*
PowerTec 28 (2 brushes)	14"	CALL*	CALL*
PowerTec 32 (2 brushes)	16"	CALL*	CALL*
PowerTec 34 (2 brushes)	17"	CALL*	CALL*
Quick 32 (2 brushes)	15"	CALL*	CALL*
Saber 24 (2 brushes)	11"	CALL*	CALL*
Saber 26 (2 brushes)	12"	CALL*	CALL*
Saber 28 (2 brushes)	13"	364112	364112BD

Machine Manufacturer's Model No	Block Dia	Suggested Carlisle Plate	Suggested EZ Snap Plate
Saber Cutter 26 (2 brushes)	12"	CALL*	CALL*
Saber Glide 28 (2 brushes)	13"	364112	364112BD
Saber Glide 28/36 (3 brushes)	11"	364112	364112BD
Saber Glide 32, Saber Cutter 32 (2 brushes)	15"	364112	364112BD
Saber 34 (2 brushes)	16"	CALL*	CALL*
Saber Compact 17	17"	CALL*	CALL*
Saber Compact 20	19"	364112	364112BD
SCC 172	17"	364174	36P74BD
Storm 13, SP13	11"	364192P	364192BD
Storm 15, SP15	13"	364192P	364192BD
Storm 17, SP17, Deluxe SP17X	15"	364192P	364192BD
Storm 20, 20X, SP20, SPS20D	18"	364192P	364192BD
Tracker AS34 (2 brushes)	17"	CALL*	CALL*
Trident Compact 17	16"	CALL*	CALL*
Trident Compact 20, 20T	19"	CALL*	CALL*
Trident TR28 (2 brushes)	14"	CALL*	CALL*
Trident TR34 (2 brushes)	17"	CALL*	CALL*

\* Fits new machines with star style plates only. Old style hex shaped plate not available from Carlisle.

**CALL\*** – Use the Rotary Wizard on the Carlisle website located in the Support section or call Customer Service at 800-654-8210.

**WARNING:** Do not use brushes, pads, or tools with flammable materials as serious bodily injury could result.



# POWER SWEEPING

Flo-Pac® power sweeping brooms are built around a heavy duty core, with staple-set tufts aligned in spiral rows. This design places bristles on the floor at all times to increase vacuum efficiency and improve pickup characteristics.

## Bristle Types

Several bristle types are available for a wide range of cleaning applications, ranked below by aggressiveness.

→ MORE AGGRESSIVE →

### Sweeping Brushes:

Union → Proex → Poly → Nylon → Union & Wire → Proex & Wire → Crinkle Wire

### Side Sweeping Brushes:

Poly → Nylon → Flat Wire

## Heavy-Duty Main Brooms

### Union & Wire Bristle Brooms

**Brush Life:** Fair to good

- Double row design for use on dry, slightly encrusted soiled surfaces and light dust conditions

### Poly & Wire Bristle Brooms

**Brush Life:** Very good

- Double row design for slightly encrusted, medium to heavy loose soiled surfaces and light dust conditions
- Good hopper loading performance
- Not recommended for sweeping higher temp debris

### Crinkle Wire Bristle Brooms

**Brush Life:** Fair to good

- Double row design with cutting action for extra heavy duty sweeping of compacted dirt
- Recommended for dry, low dust sweeping on unsealed surfaces
- Preferred for sweeping higher temp debris

### Proex & Wire Bristle Broom

**Brush Life:** Good to very good

- Double row design for slightly packed and heavy debris
- Not recommended for sweeping higher temp debris



→ MORE AGGRESSIVE →

Union & Wire → Poly & Wire → Crinkle Wire



## General Purpose Main Brooms

### Nylon Patrol Bristle Broom

**Brush Life:** Excellent

- Double row herringbone design for sweeping large indoor and outdoor areas at higher speeds
- “V” shaped pattern bristles give superior hopper loading of sand and larger items

### Proex Bristle Brooms

**Brush Life:** Good to very good

- Double row design with X-shaped polypropylene bristles
- Universal all-purpose brush
- Not recommended for sweeping higher temperature debris

### Union Bristle Brooms

**Brush Life:** Fair

- Double row design for sweeping most soiled surfaces and medium dust conditions

### Poly Bristle Brooms

**Brush Life:** Good to very good

- Double row design for sweeping most soiled surfaces
- Economical choice that retains its stiffness when wet
- For medium dust conditions
- Not recommended for sweeping higher temperature debris

### Nylon Bristle Broom

**Brush Life:** Excellent

- Double row design Nylon offers longer bristle life and good hopper loading performance
- Our most popular fill for sweeping most soiled surfaces
- Dry sweeping conditions



→ MORE AGGRESSIVE →

Nylon → Patrol Polypropylene → Nylon

## Dusty Sweeping Main Brooms

### Poly Bristle Brooms

**Brush Life:** Good

- High-density, single and double row design for loose soiled surfaces
- Available for select models.

### Nylon Bristle Brooms

**Brush Life:** Excellent

- High-density, single row design for sweeping severe dust and loose soiled surfaces
- Recommended for dry sweeping on most surfaces

### Union & Wire Bristle Brooms

**Brush Life:** Fair to good

- High-density, single row design combines Wire for cutting lightly compacted, soiled surfaces with Union fiber for heavy dust conditions



→ MORE AGGRESSIVE →

Nylon → Union & Wire



# POWER SWEEPING

## SIDE SWEEP BRUSHES

Flo-Pac® side sweep brushes are built on a rugged marine type plywood block for extra long life. Staple-set bristles are arranged in a broad flare design with a wide sweeping face that provides easy access to corners, walls, and gutters.

### Poly Bristle Side Sweeps

**Brush Life:** Good to very good

- For general purpose sweeping
- Economical and retains its stiffness when wet
- Not recommended for sweeping higher temp debris

### Nylon Bristle Side Sweeps

**Brush Life:** Excellent

- For dry sweeping on most surfaces
- Nylon offers longer bristle life

### Flat Wire Bristle Side Sweeps

**Brush Life:** Good

- For heavy duty sweeping and cutting of mud and compacted soiled surfaces
- Preferred for outdoor sweeping and for higher temp debris



→ MORE AGGRESSIVE →

Poly → Nylon → Flat Wire



## Bristle Patterns

Flo-Pac® brushes are available in several bristle patterns to match the size and power of your equipment.

### Cylindrical Sweeps

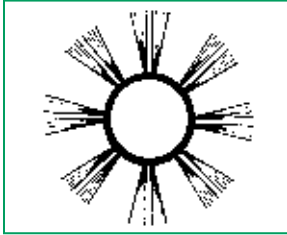

**Double Row**  
(6, 8, 12, and 16 D.R.)

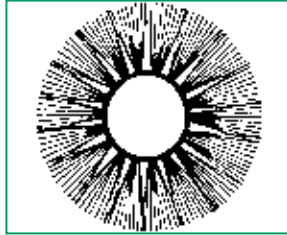

**High-Density**  
Single Row (Full-Fill)  
(16, 18, and 24 S.R.)



**Single Row**  
(18 and 24 S.R.)

### Side Sweeps

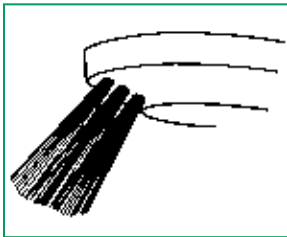

**Single Row**  
(2, 3, and 4 S.R.)

## Brush Adjustment

When replacing the cylindrical brushes on your sweeper or scrubber, the suggestions below will give longer bristle life and maximum performance:

- Follow the directions from your equipment manual to remove and install brushes
- Start the machine and lower the brush until you can hear or feel it sweep the floor; don't lower the brush any further at this time; if installing, do not turn on water
- Let the brush sweep the floor for approximately 20 seconds; raise the brush and move the machine away; a 1-1/2" to 2" wide strip on the floor where the brush made contact should be visible
- If one end is wider than the other, the brush mounting needs adjustment (refer to your equipment manual)
- Check the brush chamber to assure that the brush arms are free to move
- A properly adjusted brush mounting will increase brush performance life, reduce excessive vibration, and prevent equipment damage

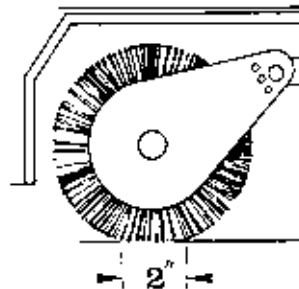

**mis-adjusted**



**properly adjusted**



TT175

WHEEL WEIGHTS: 600 LB / 272 kg

**CARLISLE**

SANITARY MAINTENANCE PRODUCTS





RUGGED  
HIGH-QUALITY  
DURABLE  
**WASTE  
MANAGEMENT  
& MATERIAL  
HANDLING  
PRODUCTS**

---

*Carlisle provides solutions for all waste management and material handling needs with a complete offering of containers and accessories. Our product quality is designed to last with a variety of receptacle options to improve productivity*





---

**We never compromise quality.** Carlisle offers extra thick, durable, plastic waste containers designed to last year after year.

---

- *Greater wall and base thickness*
- *Reinforced drag skids prolong the life of the can*
- *Molded-in notches allow for secure attachment to dolly*
- *Convenient helper handle*

# Bronco™

 | Built-In Durability

Only Carlisle continues to offer the best quality in commercial waste containers. Our Bronco's superior wall thickness is built to take a beating and is sure to outlast the competition.



## NSF 2 Certified For Food Contact

Our round Bronco containers come in 7 colors and are made with NSF 2 certified materials which meet the criteria for food contact and cleanability. Excellent for storing and segregating large amounts of food products.

Color Coding System





Square Broncos available in 28 and 40 gallon

Most waste container lines are available in recycle colors



Custom Hot Stamped Containers  
visit [carlislefsp.com/custom-imprinting](http://carlislefsp.com/custom-imprinting)





# WASTE CONTAINERS

We understand the needs of professionals and their desire for durable, long-lasting products. Count on Carlisle to provide multiple waste management solutions by continually seeking solutions, improving quality and strengthening our offerings.

## Bronco™

- Heavy-duty construction with double-reinforced stress ribs; drag skids for durability
- Comfort Curve™ handles provide easy handling
- Helper handles on base for controlled tipping or overhead lifting
- Reinforced lids have snap down tab locks with a simple press & pull release system for easy removal
- NSF Std 21 – meets the criteria for thermoplastic refuse containers
- NSF Std 2 – meets the criteria for food contact and cleanability

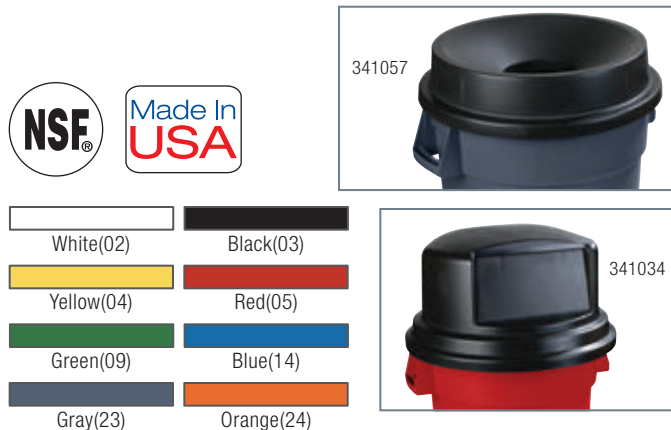

Prod No	Description	Color	Pack	Cs Wt/Cube
<b>Bronco Round Waste Containers &amp; Lids</b>				
341010 Δ	10 gal Waste Container, 16-1/8" x 17"	02, 04, 05, 09, 14, 23, 24	6 ea	16.50/5.45
341011 Δ	10 gal Lid, 16-1/8" x 2"	02, 04, 05, 09, 14, 23, 24	6 ea	5.50/0.77
341020 Δ	20 gal Waste Container, 20" x 23"	02, 04, 05, 09, 14, 23, 24	6 ea	34.80/10.97
341021 Δ	20 gal Lid, 20" x 2-1/8"	02, 04, 05, 09, 14, 23, 24	6 ea	7.65/4.57
341032 Δ	32 gal Waste Container, 22-3/8" x 27-3/4"	02, 04, 05, 09, 14, 23, 24	4 ea	34.40/13.18
341033 Δ	32 gal Lid, 24" x 2-1/8"	02, 04, 05, 09, 14, 23, 24	4 ea	7.65/2.47
341034	32 gal Dome Lid	03	1 ea	9.20/4.01
341035	32 gal Funnel Lid	03	4 ea	2.42/1.46
341044 Δ	44 gal Waste Container, 26-7/8" x 31-3/8"	02, 04, 05, 09, 14, 23, 24	3 ea	38.40/10.24
341045 Δ	44 gal Lid 26-7/8" x 2-1/4"	02, 04, 05, 09, 14, 23, 24	3 ea	8.70/2.06
341055 Δ	55 gal Waste Container, 26-1/2" x 33"	02, 04, 05, 09, 14, 23	2 ea	53.80/26.23
341056 Δ	55 gal Lid, 26-1/2" x 2-1/4"	02, 04, 05, 09, 14, 23	2 ea	7.65/3.20
341057	44/55 gal Dome Lid	03	1 ea	12.40/6.68
341132 Δ	32 gal Container with Dolly, 22-3/8" x 38-1/4"	02, 04, 05, 09, 14, 23	4 ea	66.40/17.04
341144 Δ	44 gal Container with Dolly, 26-7/8" x 37-3/4"	02, 04, 05, 09, 14, 23	3 ea	57.90/20.41

NSF Listed products are designated with a Δ and may be prefixed with an N

### 7 Colors

Our round Bronco containers come in 7 colors and are made with NSF 2 certified materials which meet the criteria for food contact and cleanability. Excellent for storing and segregating large amounts of food products.



### Hot Stamped Bronco™ Containers

- Carlisle offers several standard Hot Stamped containers for waste handling and product identification, visit [carlislefsp.com/custom-imprinting](http://carlislefsp.com/custom-imprinting)
- Standard stamps:
  - INEDIBLE      – USDA CONDEMNED
  - TRASH          – ICE MELT        – ICE ONLY
- Custom hot stamping is also available; see page 180 for more information

341010IMB



**NEW PRODUCT**

### Tool Caddy Bag

- Economical, long lasting adjustable caddy bag made of ripstop nylon for exceptional durability
- Includes 12 pockets to hold an assortment of cleaning tools ideal for applications such as hospitals, schools and hotels
- Turns a 32 or 44 gallon Bronco into a portable and durable cleaning system platform

36910



36917



### Carlisle Dollies

- Dollies fit our 20, 32, 44, and 55 gallon containers for safe transport of heavy loads
- Simple twist-to-lock feature securely attaches dolly to containers
- Dollies include standard Carlisle non-marking 3" swivel casters
- NSF Std 2—meets the criteria for food contact and cleanability

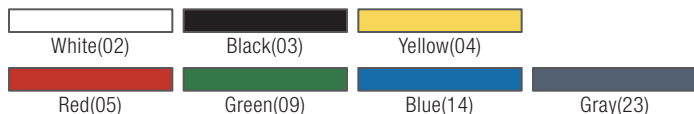

Prod No	Description	Color	Pack	Cs Wt/Cube
<b>Hot Stamped Bronco Container</b>				
341010ICE Δ	10 gal "Ice Only" Container	02	6 ea	16.50/5.45
341010IMB Δ	10 gal "Ice Melt" Container	02	6 ea	16.50/5.45
341020IMB Δ	20 gal "Ice Melt" Container	02	6 ea	34.80/10.97
341020INE Δ	20 gal Bronco Waste Container "Inedible", 20" x 23"	05	6 ea	34.80/10.97
341032INE Δ	32 gal Bronco Waste Container "Inedible", 22-3/8" x 27-3/4"	14, 23	4 ea	34.40/13.18
341044INE Δ	44 gal Bronco Waste Container "Inedible", 26-7/8" x 37-3/4"	23	3 ea	38.40/10.24
341020USD Δ	20 gal Bronco Waste Container "USDA Condemned", 20" x 23"	04	6 ea	34.80/10.97
341032USD Δ	32 gal Bronco Waste Container "USDA Condemned", 22-3/8" x 27-3/4"	04, 05	4 ea	34.40/13.18
341044USD Δ	44 gal Bronco Waste Container "USDA Condemned", 26-7/8" x 37-3/4"	04	3 ea	38.40/10.24
341032TRA Δ	32 gal Bronco Waste Container "Trash", 22-3/8" x 27-3/4"	23	4 ea	34.40/13.18
341044TRA Δ	44 gal Bronco Waste Container "Trash", 26-7/8" x 37-3/4"	14	3 ea	38.40/10.24
<b>Tool Caddy Bag</b>				
36197	Tool Caddy Bag for 32 & 44 gal Bronco Waste Containers	04	12 ea	14.74/1.78
<b>Carlisle Dollies</b>				
36911 Δ	Standard Round Container Dolly, 17-3/4" x 6"	03	2 ea	10.00/1.30
36910 Δ	Round Container Dolly with Replaceable Casters	03	2 ea	13.00/1.69
3672231	3" Replacement Caster for 36910 Dolly	—	1 ea	1.00/0.01

NSF Listed products are designated with a Δ and may be prefixed with an N



# WASTE CONTAINERS

## Square Bronco™

- Heavy-duty construction with double-reinforced stress ribs; drag skids for durability
- Comfort Curve™ handles provide easier grip for lifting large loads and avoiding messy spills
- Helper handles on base for controlled tipping or overhead lifting
- Reinforced lids have snap down tab locks with a simple press and pull release system for easy removal



Prod No	Description	Color	Pack	Cs Wt/Cube
<b>Square Bronco Waste Containers &amp; Lids</b>				
341528	28 gal Square Bronco Waste Container	02, 23	6 ea	8.76/0.16
341529	Square Bronco Lid for 341528	02, 23	6 ea	2.34/0.17
341540	40 gal Square Bronco Waste Container	02, 23	4 ea	12.65/0.25
341541	Square Bronco Lid for 341540	02, 23	4 ea	3.10/0.02
341542	Dolly for 28/40 gal Square Bronco Container	03	2 ea	4.84/0.03



### TrimLine™

- Designed for narrow spaces
- Self-venting for easier bag removal
- Corner tabs keep bag in place
- Helper handle on bottom makes lifting and dumping easier

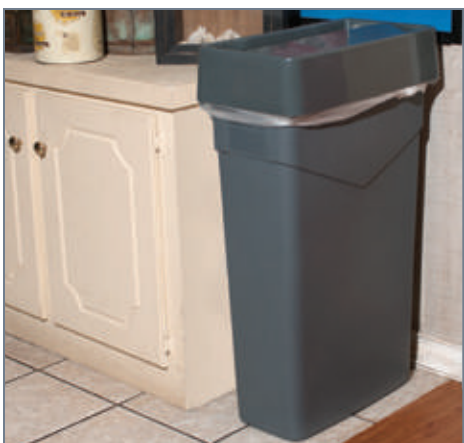

TOP SELLER



### Wire Dolly

- Compact design for easy storage
- For use with 23 gallon size container
- 100 lb weight capacity



Prod No	Description	Color	Pack	Cs Wt/Cube
<b>TrimLine Containers</b>				
342015	15 gal TrimLine Container	06, 23	4 ea	5.70/3.16
342023	23 gal TrimLine Container	03, 06, 09, 14, 23, 69	4 ea	29.60/5.91
342024	TrimLine Swing Top Lid, 20-1/8" x 11-1/2" x 4-1/2"	03, 06, 23, 69	4 ea	10.88/2.36
342025	TrimLine Handled Lid, 20-1/2" x 11-1/2" x 3"	03, 06, 09, 14, 23	4 ea	7.76/0.90
36920-1	Wire Frame Dolly for 23 gal TrimLine Container	03	1 ea	12.50/2.37



# WASTE CONTAINERS

## Centurian™

- Self-venting design for easier bag removal
- Durable plastic construction for high traffic areas in indoor and outdoor settings
- Multiple shapes and sizes to provide space saving waste management
- Corner tabs hold bag in place and avoid messy trash bags
- Great for hotels, restaurants, malls, restrooms, festivals, fairs etc.



 Recycling options shown on pages 162-163



Prod No	Description	Color	Pack	Cs Wt/Cube
<b>Centurian Waste Containers</b>				
343021	21 gal Half Round Centurian Container	06, 23	4 ea	6.51/3.99
343022	Half Round Centurian Lid for 343021	03, 06, 23	4 ea	9.20/3.44
343122	22 gal Tall Round Centurian Container	23	4 ea	6.35/4.35
343123	Swing Top Centurian Lid for 343122	23	4 ea	8.00/2.09
343124	Funnel Top Centurian Lid for 343122	23	4 ea	5.29/1.62
343523	23 gal Tall Square Centurian Container	06, 23, 69	4 ea	6.70/3.82
343525	Swing Top Centurian Lid for 343523	03, 06, 23, 69	4 ea	9.50/2.50
343935	35 gal Centurian Square Waste Receptacle	06, 23	4 ea	7.35/6.62
343950	50 gal Centurian Square Waste Receptacle	06, 23	4 ea	9.00/8.19
343951	Large Centurian Lid for 343935, 343950	06, 23	4 ea	20.00/4.23





### 50 Gallon Roll-Away Container

- Super heavy-duty axle and oversize traction wheels make hauling heavy loads easy
- Unique handle design gives positive grip even when wet
- Sturdy hinged lid flips open 270° and snaps shut tight
- NSF Std 21 – meets the criteria for thermoplastic refuse containers
- NSF Std 2 – meets the criteria for food contact and cleanability



345050



### 56 Gallon

- High capacity for indoor or outdoor use
- Corner tabs keep bag in place
- Can be used with two 23 gallon TrimLines to separate waste
- Hooded top available with or without doors
- Self-venting design for easier bag removal
- Rigid liner also available 344042



344056 with 23 gal TrimLines



344058

344056

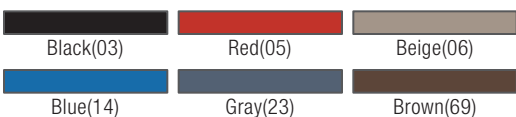

Prod No	Description	Color	Pack	Cs Wt/Cube
<b>Roll-Away Container</b>				
345050 Δ	50 gal Rolling Container, 21" x 21" x 38-1/4"	14, 23	2 ea	42.80/16.48
<b>56 Gallon Container</b>				
344056	56 gal Waste Container	06, 69	1 ea	16.50/11.68
344057	Hooded Top Without Doors for 344056	05, 69	1 ea	7.90/5.14
344058*	Hooded Top With Doors for 344056	05, 69	1 ea	7.90/5.14
344042	Rigid 42 gal Liner for 344056	03	4 ea	9.64/6.89

NSF Listed products are designated with a Δ and may be prefixed with an N  
\*344058 not compatible with 56 gal Waste Container (344056) when used with the Rigid 42 gal Liner (344042)



# WASTE CONTAINERS

## Step-On Containers

- Hands free design minimizes contact with waste
- Color-coded lids to designate and segregate types of waste
- Chemical resistant and corrosion-proof
- Assists in complying with OSHA regulation 29CFR 1910.1030, "Occupational and Blood-Borne Pathogens"



Prod No	Description	Color	Pack	Cs Wt/Cube
<b>Step-On Beige Containers with Color-Coded Lids</b>				
346144	12 gal Step-On Container	02, 05, 06	1 ea	7.91/3.55
346145	18 gal Step-On Container	02, 05, 06, 09, 14	1 ea	12.68/4.79
346146	23 gal Step-On Container	02, 05, 06, 09, 14	1 ea	15.40/5.70



### Office Wastebaskets

- Economical polypropylene
- Smooth inner surface makes cleaning easy
- Light yet durable design

 Recycling options shown on pages 162-163



### Fire Resistant Wastebaskets

- Ideal for use in areas or applications where fires need to be contained such as schools, healthcare facilities or in a hospitality setting
- Our Fire Resistant Wastebaskets won't melt under the heat of a fire and do not accelerate the spread of flames
- Textured finish minimizes appearance of scuffs and scratches
- UL Listed; will contain burning paper without contributing fuel to the fire



Prod No	Description	Color	Pack	Cs Wt/Cube
<b>Office Wastebaskets</b>				
342913	13 qt Office Wastebasket	03, 06, 23	12 ea	42.24/2.07
342928	28 qt Office Wastebasket	03, 06, 23	12 ea	51.48/4.02
342941	41 qt Office Wastebasket	03, 06, 23	12 ea	88.00/5.90
<b>Fire Resistant Wastebaskets</b>				
342915	14 qt Fire Resistant Wastebasket	03	6 ea	20.00/0.67
342927	28 qt Fire Resistant Wastebasket	03	6 ea	33.00/1.22
342940	41 qt Fire Resistant Wastebasket	03	4 ea	32.00/3.07



# WASTE CONTAINERS

We are here to support your sustainability as a business with a wide assortment of recycling waste management solutions. Many shapes, colors, lids and sizes are available to meet your unique recycling needs.

## Bronco™



341032REC



341032REC

341033REC

## Centurian™



343523REC

343527REC



343935REC

343937REC



343021REC

343022



Prod No	Description	Color	Pack	Cs Wt/Cube
<b>Bronco Recycle Waste Containers &amp; Lids</b>				
341020REC Δ	20 gal Recycle Waste Container	09, 14	6 ea	34.80/10.97
341021REC Δ	20 gal Recycle Lid with 8" Hole	09, 14	6 ea	7.65/4.57
341032REC Δ	32 gal Recycle Waste Container	09, 14	4 ea	34.40/13.18
341033REC Δ	32 gal Recycle Lid with 8" Hole	09, 14	4 ea	7.65/2.47
341044REC Δ	44 gal Recycle Waste Container	09, 14	3 ea	38.40/10.24
341045REC Δ	44 gal Recycle Lid with 8" Hole	14	3 ea	8.70/2.06
<b>Centurian Recycle Waste Containers &amp; Lids</b>				
343021REC	21 gal Half Round Centurian Recycle Container	14	4 ea	6.51/3.99
343022	Half Round Centurian Lid for 343021REC	03	4 ea	9.20/3.44
343523REC	23 gal Tall Square Centurian Recycle Container	14	4 ea	6.70/3.82
343526REC	Paper Recycle Centurian Lid for 343523REC	14	4 ea	9.0/2.50
343527REC	Bottle/Can Recycle Centurian Lid for 343523REC	14	4 ea	9.0/2.50
343935REC	35 gal Recycle Centurian Square Waste Receptacle	14	4 ea	7.35/6.62
343950REC	50 gal Recycle Centurian Square Waste Receptacle	14	4 ea	9.00/8.19
343936REC	Bottle/Can Recycle Centurian Lid for 343935REC, 343950REC	14	4 ea	5.0/4.12
343937REC	Paper Recycle Centurian Lid for 343935REC, 343950REC	14	4 ea	5.0/2.65
34RECLBL	Recycle Label Kit	—	1 ea	0.30/0.01

NSF Listed products are designated with a Δ and may be prefixed with an N



TrimLine™



Roll-Away



Office Wastebaskets



56 Gallon



Recycle Label Kit



34RECLBL

Includes one set of eleven color-coded symbol labels and three sets of eleven word labels in English, Spanish and French

Prod No	Description	Color	Pack	Cs Wt/Cube
<b>TrimLine Recycle &amp; Compost Containers &amp; Lids</b>				
342015REC	15 gal TrimLine Recycle Container	14	4 ea	5.7/3.16
342023REC	23 gal TrimLine Recycle Container	09, 14	4 ea	29.60/5.91
342023CMP	23 gal TrimLine Compost Container	09	4 ea	29.60/5.91
342026REC	Paper Recycle Lid for 343023REC & 342015REC	14	4 ea	4.25/1.82
342027REC	Bottle/Can Recycle Lid for 343023REC & 342015REC	14	4 ea	4.25/1.82
342025	TrimLine Handled Lid	03, 09, 14	4 ea	5.10/0.90
<b>Carlisle Roll-Away Recycle Container</b>				
345050REC Δ	50 gal Recycle Rolling Container	14	2 ea	42.80/16.48
<b>56 Gallon Recycle Container &amp; Lid</b>				
344056REC	56 gal Recycle Waste Container	14	1 ea	16.50/11.68
344057REC	Recycle Lid for 344056REC	14	1 ea	1.50/7.88
<b>Office Recycle Wastebaskets</b>				
342913REC	13 qt Office Recycle Wastebasket	14	12 ea	42.24/2.07
342928REC	28 qt Office Recycle Wastebasket	14	12 ea	51.48/4.02
342941REC	41 qt Office Recycle Wastebasket	14	12 ea	88.00/5.90
<b>Recycle Label Kit</b>				
34RECLBL	Recycle Label Kit	—	1 ea	0.30/0.01

NSF Listed products are designated with a Δ and may be prefixed with an N



## TILT TRUCKS

- Durable, rotationally molded construction with sturdy, reinforced rim and molded-in handles
- Smooth inner surface makes cleaning easy
- Textured outer surface hides scratches and helps maintain daily appearance
- Perfect for transporting bulky loads and/or consolidating smaller loads for more efficient transport
- Made with post consumer recycled material
- Meets EPA recommended recovered materials content levels for office recycling containers and waste receptacles and is perfect for specifying on school and government agency bids
- Rear wheels: 5" swivel casters with rubber tread
- Front wheels: 12" HDPE injection molded wheels
- Easy on/off wheels for quick replacement





TT005



TT175



TT110



Black(03)

Prod No	Description	Weight Capacity	Color	Pack	Cs Wt/Cube
<b>Tilt Trucks</b>					
TT005	.5 Cubic Yard Utility Duty Tilt Truck	400 lb/182 kg	03	1 ea	80.25/36.59
TT105	.5 Cubic Yard Standard Duty Tilt Truck	825 lb/374 kg	03	1 ea	87.25/36.59
TT175	.75 Cubic Yard Standard Duty Tilt Truck	825 lb/374 kg	03	1 ea	100.00/42.99
TT010	1 Cubic Yard Utility Duty Tilt Truck	825 lb/374 kg	03	1 ea	124.25/59.58
TT110	1 Cubic Yard Standard Duty Tilt Truck	1200 lb/544 kg	03	1 ea	130.25/59.58



# UTILITY CARTS

Our unique combination of **space saving design, load capacity, and long-lasting durability** provide superior value and make Fold 'N Go the transport cart **every operation needs.**

## Fold 'N Go® Carts

- Folds and unfolds in a single, quick and easy motion
- Each cart holds up to 350 lbs (approximately 116 lbs per shelf)
- Cart ships fully assembled; no tools or complicated latches required
- Collapses to 9" width and 10-1/2" width; stores easily behind doors, in between counters, or back of delivery vans
- Shelves are easy to clean; top shelf has ergonomically shaped, easy grip handles at both ends for a fast, secure grip
- SBC1521 shelf measures 20-1/2" L x 15" W; SBC2031 shelf measures 31-1/2" L x 18-1/2" W; with 11-1/2" shelf spacing
- 4" heavy-duty, non-marking swivel casters with molded-in metal reinforcement plates are permanently staked to 3/4" solid aluminum legs for longer life and added strength and rigidity

Licensed Product under U.S. Patent No. 5806864

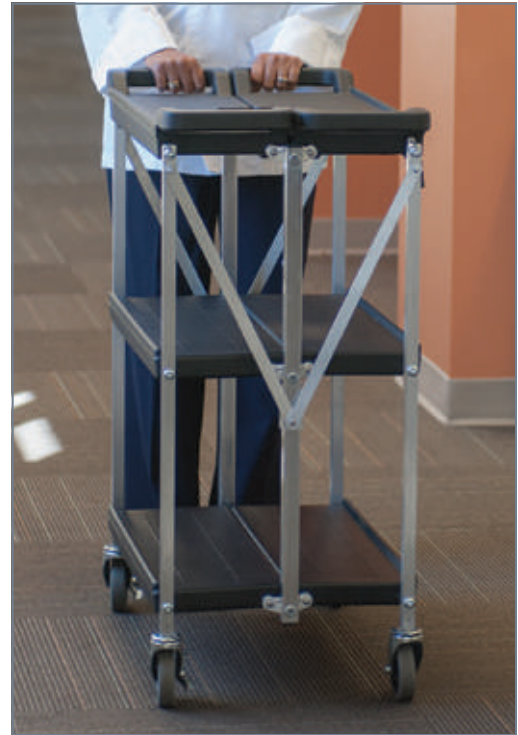

SBC1521



350 lb Capacity



Easily folds with one hand





## Transport Carts

- Carlisle ensures employee safety by providing optional locking doors to secure sensitive items like harmful chemicals or cleaning supplies (15" x 21" size only)
- Also available with optional back panels to hide clutter (15" x 21" size only)
- Durable construction stands up to the toughest use
- Shelves are textured to minimize scratches and provide a better grip
- Convenient knockdown design is easy to assemble



CC2243  
42" x 23" size



CC2036DP, available with locking doors and side panels to secure sensitive items



Raised edges on shelves help keep contents secure during transport

Trash Bin (CC11TH) available separately

Accessory Bin (CC11SH) available separately

Side panels help hide clutter



CC2036

Cart moves on 4" heavy-duty non-marking swivel casters

Raised edges on shelves help keep contents secure during transport



Prod No	Description	Wt Capacity	Color	Pack	Cs Wt/Cube
<b>Fold 'N Go Carts</b>					
SBC1521	15" x 21" Fold 'N Go Cart	350 lb	03, 23, 25	1 ea	45.45/6.89
SBC2031	20" x 31" Fold 'N Go Cart	350 lb	03, 23, 25	1 ea	51.00/10.60
SBCC240	Fold 'N Go Cart Replacement Caster, Swivel	—	—	1 ea	2.15/0.12
SBCC245	Fold 'N Go Cart Replacement Caster, Swivel with Brake	—	—	1 ea	2.15/0.12
<b>Transportation Carts</b>					
CC2243 Δ	42" x 23" Large Transport Cart	300 lb	03	1 ea	69.00/9.89
CC2036 Δ	18" x 36" Transport Cart	300 lb	03	1 ea	43.82/7.58
CC2036DP	18" x 36" Transport Cart with Doors and Back Panels	300 lb	03	1 set	51.75/11.59
CC2036P	18" x 36" Transport Cart with Back Panels	300 lb	03	1 set	48.95/9.90
CD2036	18" x 36" Doors and Back Panels Only	—	03	1 set	7.93/1.93
CP2036	18" x 36" Cart Back Panels Only	—	03	1 set	5.20/1.13
CC11SH	Accessory Bin for Transport Cart	—	03	1 ea	5.16/1.26
CC11TH	Trash Bin for Transport Cart	—	03	1 ea	9.23/3.18

NSF Listed products are designated with a Δ and may be prefixed with an N  
Note: SBC1521 can ship UPS/FedEx Ground at oversize cost, SBC2031 cannot ship UPS/FedEx Ground



# UTILITY CARTS

## Service Cart

- One-piece design, all plastic construction
- Polyethylene exterior and polyurethane foam core for added strength
- Heavy-duty 5" non-marking caster with molded-in metal reinforcement plates
- Optional Trash Container (SBC11TC) and Part Holder (SBC11SH) available separately
- NSF Listed



SBC230 with SBC11TC and SBC11SH

## Stainless Steel Utility Carts

- Utility carts are constructed of heavy gauge stainless steel for superior strength and durability
- Continuous weld construction provides added durability as compared to other, spot welded utility carts
- Non-marking soft rubber bumpers prevent scratches and scuffs on walls



UC4031529



UC3031524



UC7022133

Black(03)

Prod No	Description	Wt Capacity	Color	Pack	Gs Wt/Cube
<b>Service Cart</b>					
SBC230 $\Delta$	Service Cart - 2 Fixed Casters, 2 Swivel Casters, 1 with Brake	500 lb	03	1 ea	57.00/14.29
SBC11SH	Part Holder for SBC230	500 lb	03	1 ea	3.50/0.89
SBC11TC	Trash Container for SBC230	500 lb	03	1 ea	9.15/2.17
<b>Stainless Steel Utility Carts</b>					
UC3031524	15-1/2" x 24", 3 Shelf Utility Cart	300 lb	—	1 ea	29.60/7.00
UC3031827	18" x 27", 3 Shelf Utility Cart	300 lb	—	1 ea	40.20/9.50
UC5031524	15-1/2" x 24", 3 Shelf Utility Cart	500 lb	—	1 ea	44.00/7.30
UC5031827	18" x 27", 3 Shelf Utility Cart	500 lb	—	1 ea	57.50/9.50
UC5032135	21" x 35", 3 Shelf Utility Cart	500 lb	—	1 ea	70.00/15.90
UC7031524	15-1/2" x 24", 3 Shelf Utility Cart	700 lb	—	1 ea	69.00/7.50
UC7031827	18" x 27", 3 Shelf Utility Cart	700 lb	—	1 ea	90.10/9.70
UC7022133	21" x 33", 2 Shelf Utility Cart	700 lb	—	1 ea	130.30/15.00
UC7032133	21" x 33", 3 Shelf Utility Cart	700 lb	—	1 ea	139.30/15.00
UC4031529	15-3/4" x 29-1/2", 3 Shelf Knock-Down Utility Cart	400 lb	—	1 ea	31.00/2.50
UC4031733	17-3/4" x 33-3/8", 3 Shelf Knock-Down Utility Cart	400 lb	—	1 ea	33.00/3.20

NSF Listed products are designated with a  $\Delta$  and may be prefixed with an N

Shipping Notes: SBC230, UC3031524, UC3031827, UC5031524, UC5031827, UC5032135, UC7031524, UC7031827, UC7022133, UC7032133 cannot ship UPS/FedEx



### Utility Carts

- Excellent for transporting equipment and heavy loads
- Bin top utility carts (UC4018 & UC4525) reduce the potential for items to fall off during transport
- Durable and chemical-resistant polypropylene construction; will not rust, dent, chip, or peel
- Convenient knock-down design
- Integrated cord wrap for easy access (UC1940)



UC4018



UC1940

Gray(23)

Prod No	Description	Wt Capacity	Color	Pack	Cs Wt/Cube
<b>Utility Carts</b>					
UC1940	19" x 40" x 32-1/2" Utility Cart	500 lb	23	1 ea	45.05/5.29
UC4018	40" x 17-1/4" Small Bin Top Utility Cart	500 lb	23	1 ea	35.27/3.31
UC4525	45" x 25" Large Bin Top Utility Cart	500 lb	23	1 ea	41.45/5.82



# UTILITY CARTS

## Janitorial Carts & Accessories

- Rugged polypropylene resists cracking, peeling, and corrosion
- Three durable shelves with raised edges keep items organized
- Platform base holds a Bucket/Wringer or 23 gallon TrimLine™ Waste Container
- Includes a 25 gallon nylon bag for waste or laundry collection
- 3" standard Carlisle non-marking swivel casters in front; large 8" non-marking rear wheels





Integrated tool holders, shelves, and hooks keep everything organized including unwieldy handles.



Front hooks hold most standard Wet Floor Signs. Built-in hanger holds multiple spray bottles.

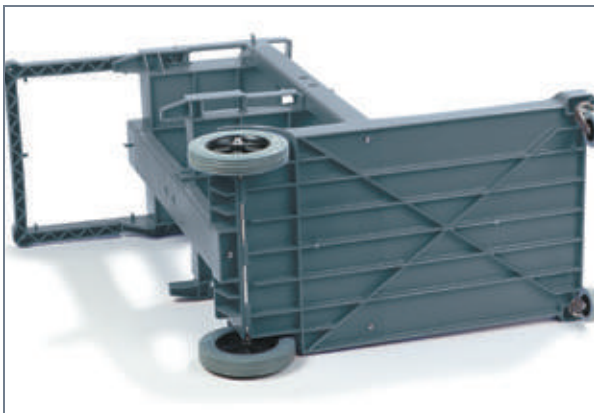

Structurally reinforced base and heavy-duty casters/wheels withstand rough use – holds up to 300 lbs.



Tough 25 gallon nylon bag easily attaches to cart arm. Hooks on top of arm to hold trash liners in place. Arm swings up for more compact storage when not in use.

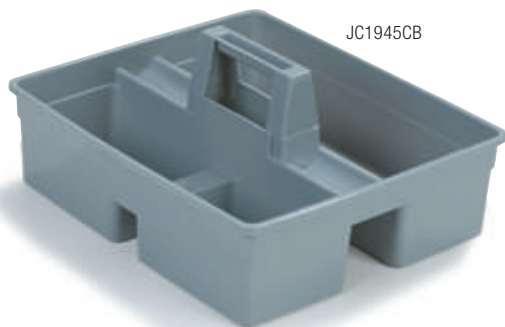

JC1945CB

### Tool Caddy

- Handled caddy fits in the top compartment of the JC1945 cart series
- Deep compartments prevent spills
- Made of durable polypropylene



Prod No	Description	Weight Capacity	Color	Pack	Cs Wt/Cube
<b>Janitorial Carts &amp; Accessories</b>					
JC1945S	45"L x 19"W x 39"H Short Platform Janitorial Cart	300 lb	23	1 ea	33.00/4.45
JC1945L	49"L x 19"W x 39"H Long Platform Janitorial Cart	300 lb	23	1 ea	41.00/4.49
JC1946	Replacement Bag for JC1945S & JC1945L	—	14	1 ea	1.14/0.06
JC1945CB	Tool Caddy for Janitorial Cart	—	23	1 ea	8.25/1.52
36908C	3" Replacement Casters	—	00	2 ea	8.0/2.88



# TOTE BOXES & ACCESSORIES

## Tote Boxes

- Unique reinforced rims reduce bending, bowing, and breaking
- Comfort Curve™ handles for a sure, comfortable grip
- Contour lid design allows easy box-on-box stacking
- Available in 8 different colors for HACCP zone use
- NSF Listed for storage and handling applications requiring food contact



**NEW  
PRODUCT**

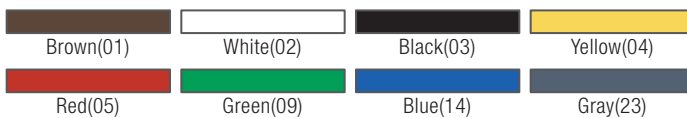

Prod No	Description	Color	Pack	Cs Wt/Cube
<b>Tote Boxes</b>				
N44010 Δ	Tote Box 15" x 20" x 5" Deep	01, 02, 03, 04, 05, 09, 14, 23	12 ea	23.00/3.49
N44011 Δ	Tote Box 15" x 20" x 7" Deep	01, 02, 03, 04, 05, 09, 14, 23	12 ea	27.50/3.82
N44012 Δ	Universal Lid	01, 02, 03, 04, 05, 09, 14, 23	12 ea	11.50/0.95

NSF Listed products are designated with a Δ and may be prefixed with an N



## Bus Boxes

- Unique reinforced rims reduce bending, bowing, and breaking – protecting your valuable
- Used for storing tools, replacement parts, cleaning chemicals etc.
- Comfort Curve™ handles provide easier grip for lifting large loads and avoiding messy spills
- Contour lid design allows easy box-on-box stacking
- 44010, 44011, 44012 in White are NSF Listed



## Floor Rack System

- Interlocking modular system is designed to provide a raised surface in storage areas, coolers, and freezers
- Perfect for areas where moisture collects on the floor; keeping tools, food products or other items elevated for more sanitary storage
- 12" x 12" x 1-1/2" square units lock together to provide a tight fit and an even surface
- Holds up to 3,000 pounds per square foot
- Made of FDA compliant high density polyethylene; withstands temperatures from -40°F to 180°F
- Cleans easily in dishwasher or with hose
- NSF Listed



Prod No	Description	Wt Capacity	Color	Pack	Cs Wt/Cube
<b>Bus Boxes</b>					
44010 Δ	Bus Box 15" x 20" x 5" Deep	—	01, 02, 03, 23	12 ea	24.80/3.49
44011 Δ	Bus Box 15" x 20" x 7" Deep	—	01, 02, 03, 23	12 ea	26.56/3.82
44012 Δ	Universal Lid for Bus Box	—	01, 02, 03, 23	12 ea	12.90/0.95
<b>Floor Rack System</b>					
2710 Δ	12" Square Floor Rack	3,000 lb	23	12 ea	19.15/2.09

NSF Listed products are designated with a Δ and may be prefixed with an N

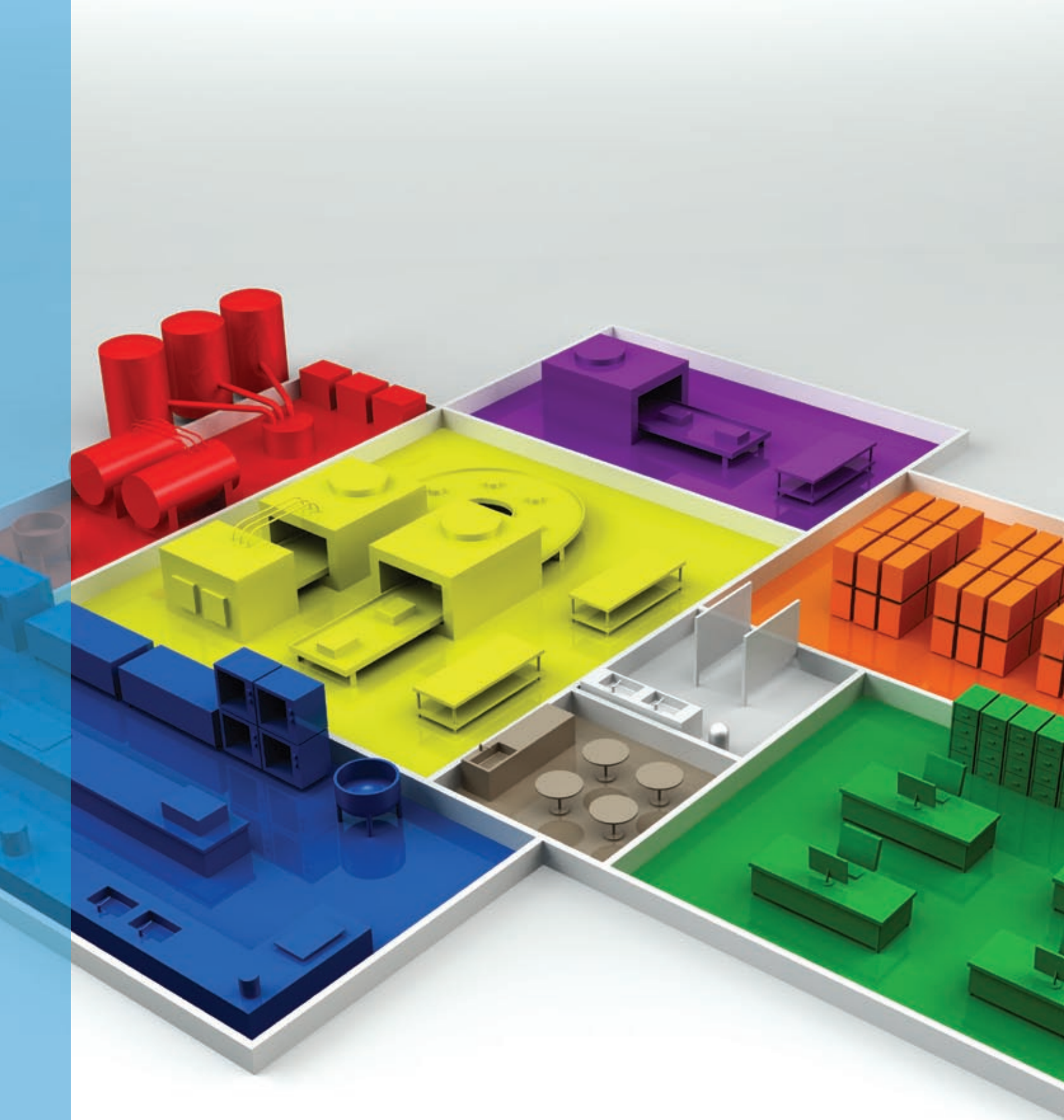

**CARLISLE**



# GUIDES RESOURCES INFORMATION **REFERENCE**

*From the Handle Guide to Critical Control Point Products to the Bristle Guide, Carlisle's reference section provides you with information to help you make the right choices in your cleaning tool selections to ultimately make your work easier.*



# HANDLE GUIDE

Item	Page	Description	Type of Handle	Recommended Handle
<b>Floor Sweeps Handle Guide</b>				
<b>Duo-Sweep Angle Brooms</b>				
36861	58	6-1/2" Flagged Duo-Sweep Angle Broom with 30" Metal Handle	Threaded	3620294
36865/36867	58/58	12" Flagged Duo-Sweep Medium Duty Angle Broom	Threaded	3620294
36885/36868	58/58	12" Unflagged Duo-Sweep Angle Broom	Threaded	3620294
41082	58	12" Flagged Duo-Sweep Broom with 48" Fiberglass Handle	Threaded	41225
41083	53, 58	12" Unflagged Duo-Sweep Angle Broom with 48" Fiberglass Handle	Threaded	41225
<b>Duo-Sweep Brooms</b>				
36859	59	7-1/2" Flagged Duo-Sweep Lobby Broom with 30" Black Metal Handle	Threaded	3620194
36860	59	7-1/2" Unflagged Duo-Sweep Lobby Broom with 30" Black Metal Handle	Threaded	3620294
36863/36853	59/59	11" Flagged Duo-Sweep Light Industrial Broom with 48" Blue Metal Handle	Threaded	3620194
36864/36854	59/59	11" Unflagged Duo-Sweep Light Industrial Broom with 48" Blue Metal Handle	Threaded	3620294
36883/36873	59/59	13" Flagged Duo-Sweep Warehouse Broom with 48" Blue Metal Handle	Threaded	3620194
36884/36874	59/59	13" Unflagged Duo-Sweep Warehouse Broom with 48" Black Metal Handle	Threaded	3620294
<b>Floor Sweeps</b>				
40561	68	18" Foam Block Medium Sweep	Threaded	40225
40562	68	24" Foam Block Medium Sweep	Threaded	40225
40564	69	18" Foam Block Medium Sweep	Threaded	40225
40565	69	24" Foam Block Medium Sweep	Threaded	40225
41870	64	18" Anchor Style Omni Sweep	Anchor	45270
41871	64	24" Anchor Style Omni Sweep	Anchor	45270
41872	64	36" Anchor Style Omni Sweep	Anchor	45270
41880	64	18" Omni Sweep	Threaded	40225
41881	64	24" Omni Sweep	Threaded	40225
41890	64	18" Omni Sweep	Threaded	40225
41891	53, 64	24" Omni Sweep	Threaded	40225
45013	68	18" Flagged Polypropylene Sweep	Threaded	45267
45014	68	24" Flagged Polypropylene Sweep	Threaded	45267
45016	68	36" Flagged Polypropylene Sweep	Threaded	45267
45030	68	18" Blended Horsehair Sweep	Threaded	45267
45031	68	24" Blended Horsehair Sweep	Threaded	45267
45032	68	36" Blended Horsehair Sweep	Threaded	45267
45040	70	18" Horsehair Blend Sweep with Tampico Center	Threaded	45267
45041	70	24" Horsehair Blend Sweep with Tampico Center	Threaded	45267
45043	70	36" Horsehair Blend Sweep with Tampico Center	Threaded	45267
45051	69	14" Tampico Sweep	Threaded	45267
45053	69	18" Tampico Sweep	Threaded	45267
45054	69	24" Tampico Sweep	Threaded	45267
45056	69	36" Tampico Sweep	Threaded	45267
45072	69	18" Polypropylene Sweep	Threaded	45267
45073	69	24" Polypropylene Sweep	Threaded	45267
45074	69	36" Polypropylene Sweep	Threaded	45267
45135	71	18" Tampico Sweep with Wire Center	Threaded	3620055
45136	71	24" Tampico Sweep with Wire Center	Threaded	3620055
45201	72	18" Heavy Polypropylene Sweep	Threaded	3620055
45202	72	24" Heavy Polypropylene Sweep with Brace	Threaded	3620055
45204	72	36" Heavy Polypropylene Sweep with Brace	Threaded	3620055
45221	72	18" Palmyra Floor Sweep	Threaded	3620055
45222	72	24" Palmyra Floor Sweep with Brace	Threaded	3620055
45224	72	36" Palmyra Floor Sweep with Brace	Threaded	3620055
362018	70	18" Horsehair Blend Sweep with Polypropylene Center	Threaded	45267
362024	70	24" Horsehair Blend Sweep with Polypropylene Center	Threaded	45267
362036	70	36" Horsehair Blend Sweep with Polypropylene Center	Threaded	45267
362218	70	18" Polypropylene Sweep with Heavy Polypropylene Center	Threaded	45267
362224	70	24" Polypropylene Sweep with Heavy Polypropylene Center	Threaded	45267
362236	70	36" Polypropylene Sweep with Heavy Polypropylene Center	Threaded	45267
366224	71	24" Polypropylene Sweep with Heavy Polypropylene Center	Threaded	3620055
367618	72	18" Heavy-Duty Sweep	Threaded	3620055
367624	72	24" Heavy-Duty Sweep	Threaded	3620055



Item	Page	Description	Type of Handle	Recommended Handle
369524	73	24" Polypropylene Sweep with Steel Scraper Blade	Juno	3620405
3601236	71	36" Tampico Sweep with Wire Center	Threaded	3620055
3602418	71	18" Horsehair/Polypropylene Sweep with Wire Center	Threaded	3620055
3602424	71	24" Horsehair/Polypropylene Sweep with Wire Center	Threaded	3620055
3602436	71	36" Horsehair/Polypropylene Sweep with Wire Center	Threaded	3620055
3643418	68	18" Horsehair Sweep	Threaded	45267
3643424	68	24" Horsehair Sweep	Threaded	45267
3643436	68	36" Horsehair Sweep	Threaded	45267
36102218	70	18" Juno Style PPY Sweep with Heavy Polypropylene Center	Juno	3620405
36102224	70	24" Juno Style PPY Sweep with Heavy Polypropylene Center	Juno	3620405
36102236	70	36" Juno Style PPY Sweep with Heavy Polypropylene Center	Juno	3620405
36107624	72	24" Juno Style Polypropylene Sweep	Juno	3620405
36204818	68	18" Foam Block Fine Sweep	Threaded	40225
36204824	68	24" Foam Block Fine Sweep	Threaded	40225
36207218	72	18" Foam Block Heavy Sweep	Threaded	3620055
36207224	72	24" Foam Block Heavy Sweep	Threaded	3620055
36219618	65	18" Sweep Complete Floor Sweep with Squeegee	Threaded	40224
36219624	65	24" Sweep Complete Floor Sweep with Squeegee	Threaded	40224
362208P18	69	18" Foam Block Medium Sweep	Threaded	40225
362208P24	69	24" Foam Block Medium Sweep	Threaded	40225
<b>Street Sweeps</b>				
361116	73	16" Heavy Polypropylene Sweep	Tapered	40262
361118	73	18" Heavy Polypropylene Sweep	Tapered	40262
361124	73	24" Heavy Polypropylene Sweep	Tapered	40262
36113016	73	16" Heavy Polypropylene Sweep	Tapered	40262
36113018	73	18" Heavy Polypropylene Sweep	Tapered	40262
36113024	73	24" Heavy Polypropylene Sweep	Tapered	40262
36114016	73	16" Heavy Polypropylene Sweep	Tapered	40262
36114018	73	18" Heavy Polypropylene Sweep	Tapered	40262
36114024	73	24" Heavy Polypropylene Sweep	Tapered	40262
36219416	73	16" Palmyra Stalk Street Broom	Tapered	40262
<b>Floor &amp; Deck Scrub Brushes</b>				
36175	75	10" Wood Block Sweep	Threaded/Tapered	45267
36190	74	10" Dual Action Scrub Brush	Threaded	40225
36191	75	10" Silicone Carbide Impregnated Nylon Deck Scrub	Threaded/Tapered	45267
36192	75	10" Wood Block Sweep	Threaded/Tapered	45267
36193	75	10" Wood Block Scrub	Threaded/Tapered	45267
36197	74, 155	10" Dual Surface Scrub Brush	Threaded	40225
36275	75	12" Wood Block Sweep	Threaded/Tapered	45267
36292	75	12" Wood Block Scrub	Threaded/Tapered	45267
36395	75	14" Palmyra Deck Scrub with Squeegee	Threaded/Tapered	45267
40421	74	10" Hi-Lo Polypropylene Floor Scrub with Squeegee	Threaded	45267
40422	74	10" Dual Action Scrub Brush	Threaded	40225
40423	74, 53	10" Hi-Lo Floor Scrub Brush	Threaded	40225
40430	76	9" Floor Scrub Brush	Threaded	40225
41323	77	9" Tile & Grout Brush	Threaded	40225
361966	78	Triangle Scrubber with Polypropylene Bristles	Threaded	45267
365300	76	8" Swivel Scrub	Threaded	40225
365310	76	8" Swivel Scrub	Threaded	40225
365320	77	Swivel Head Grout Brush	Threaded	40225
3638831	76	8" Swivel Scrub with Polyester Bristles	Threaded	40224
36193MX	75	10" Polypropylene Deck Scrub	Threaded/Tapered	45267
36193P	75	10" Polypropylene Deck Scrub	Threaded/Tapered	45267
36293P	75	12" Polypropylene Deck Scrub	Threaded/Tapered	45267
<b>Misc Floor Brushes</b>				
36297	79	18" Pile Brush with Nylon Bristles	Tapered	40261
36397	79	18" Pile Brush with Extra-Stiff Nylon Bristles	Tapered	40261
40146	53, 78	3" Floor Drain Brush	Female Threaded	40236
40147	78	4" Floor Drain Brush	Female Threaded	40237

# HANDLE GUIDE

Item	Page	Description	Type of Handle	Recommended Handle
40148	78	6" Floor Drain Brush	Female Threaded	40238
41078	79	8" Floor Scraper with Tapered Zinc Handle Socket	Tapered	40261
41093	78	5" Floor Drain Brush	Female Threaded	40237
41619	53, 79	8" Floor Scraper with Polycarbonate Threaded Handle Socket	Threaded	40225

## Mopping Solutions Handle Guide

### Microfiber and Dust Mops

36490	86	Wedge Dust Mop	Threaded	45267
41672	86	24" Mop Frame	Clip-On/Flexible	364105
41673	86	36" Mop Frame	Clip-On/Flexible	364105
3647248	86	48" Mop Frame	Clip-On/Flexible	364105

### Looped-End Mops

369320	91	Rough n' Ready Rough Surface Mop	Quick Change/Quick Release	41664
369420	91	Medium Looped-End Microfiber Mop	Jaw Style	369475
369430	90	X-Large Blue Band Mop	Jaw Style	369475
369460	90	X-Large Blue Band Mop	Jaw Style	369475
369412B	90	Small Yellow Band Mop	Jaw Style	369475
369413B	90	Small Yellow Band Mop	Quick Change/Quick Release	369595
369418B	90	Medium Green Band Mop	Jaw Style	369475
369419B	90	Medium Green Band Mop	Quick Change/Quick Release	369595
369424B	90	Large Red Band Mop	Jaw Style	369475
369425B	90	Large Red Band Mop	Quick Change/Quick Release	369595
369442B	90	Small Yellow Band Mop	Jaw Style	369475
369448B	90	Medium Green Band Mop	Jaw Style	369475
369454B	90	Large Red Band Mop	Jaw Style	369475
369472B	90	Small Yellow Band Mop	Jaw Style	369475
369478B	90	Medium Green Band Mop	Jaw Style	369475
369484B	90	Large Red Band Mop	Jaw Style	369475
369550B	90	Small Yellow Band Mop	Jaw Style	369475
369551B	90	Medium Green Band Mop	Jaw Style	369475
369552B	90	Large Red Band Mop	Jaw Style	369475
369670B	92	#20 Medium Mop Head	Quick Change/Quick Release	369595
369674B	92	#24 Large Mop Head	Quick Change/Quick Release	369595

### Cut-End Mops

369082	93	#32 X-Large Mop Head	Quick Change/Quick Release	40340
369724	93, 94	#24 Large Cut-End Mop Head	Quick Change/Quick Release	40340
369732	93, 94	#32 X-Large Cut-End Mop Head	Quick Change/Quick Release	40340
369832	92	#32 X-Large Mop Head	Quick Change/Quick Release	40340
369832	92	#32 X-Large Cut-End Mop	Jaw Style	36970
369024C	94	#24 Kwik-On Cotton Mop Head	Kwik-On	40345
369024R	94	#24 Kwik-On Rayon Mop Head	Kwik-On	40345
369066B	93	#16 Small Mop Head	Quick Change/Quick Release	40340
369070B	93	#20 Medium Mop Head	Quick Change/Quick Release	40340
369074B	93	#24 Large Mop Head	Quick Change/Quick Release	40340
369811B	92	#16 Small Cut-End Mop	Jaw Style	36970
369816B	92	#16 Small Mop Head	Quick Change/Quick Release	40340
369820B	92	#20 Large Mop Head	Quick Change/Quick Release	40340
369820B	92	#20 Medium Cut-End Mop	Jaw Style	36970
369824B	92	#24 Large Mop Head	Quick Change/Quick Release	40340
369824B	92	#24 Large Cut-End Mop	Jaw Style	36970

### Wax Applicator

361600	95	16" Applicator	Threaded	45267
--------	----	----------------	----------	-------

## Squeegees & Window Cleaning Handle Guide

### Double Foam Squeegees

40081	80	18" Straight Steel Squeegee	Tapered	40261
40082	80	24" Straight Steel Squeegee	Tapered	40261
40083	80	30" Straight Steel Squeegee	Tapered	40261
41567	81	18" Plastic Squeegee	Threaded	40225
41568	81	24" Plastic Squeegee	Threaded	40225
366222	81	22" Soft Black Foam Rubber	15/16" Threaded/Tapered	40210



Item	Page	Description	Type of Handle	Recommended Handle
366230	81	30" Soft Black Foam Rubber	15/16" Threaded/Tapered	40210
366318	80	18" Straight Squeegee	Tapered	40261
366324	80	22" Foam Squeegee	Tapered	40261
366330	80	30" Soft Black Foam Rubber	Tapered	40261
366530	80	30" Red Foam Rubber Squeegee	Tapered	40261
366724	80	22" Reinforced Soft Black Foam Heavy Duty Rubber	Straight	40261
366824	80	22" Foam Squeegee Threaded Socket	Threaded	40267
366918	81	18" Red Foam Rubber	15/16" Threaded/Tapered	40210
366922	81	22" Red Foam Rubber	15/16" Threaded/Tapered	40210
366930	81	30" Red Foam Rubber	15/16" Threaded/Tapered	40210
367818	81	18" Rubber Squeegee with Bristles	Threaded	40210
<b>Single Rubber Blade Squeegees</b>				
36567	82	20" Rubber Squeegee	Threaded	40225
36568	82	24" Rubber Squeegee	Threaded	40225
40075	83	18" Straight Steel Squeegee	Tapered	40261
40076	83	24" Straight Steel Squeegee	Tapered	40261
40077	83	36" Straight Steel Squeegee	Tapered	40261
40078	82	24" Curved End Red Gum Rubber Squeegee	Tapered	40261
366024	83	24" Gray Vinyl Blade with Metal Frame	Tapered	40261
366036	83	36" Gray Vinyl Blade with Metal Frame	Tapered	40261
366124	83	24" Push/Pull Gray Vinyl with Non-Sparking Frame	Tapered	40261
3612018	83	18" Straight Blade Black Rubber with Metal Frame	Tapered	40261
3612024	83	24" Straight Blade Black Rubber with Metal Frame	Tapered	40261
3612036	83	36" Straight Blade Black Rubber with Metal Frame	Tapered	40261
36324C	82	24" Curved End Black Rubber Squeegee	Tapered	40261
36336C	82	36" Curved End Black Rubber Squeegee	Tapered	40261
<b>VersaClean Brush &amp; Squeegee</b>				
36592	84	12" VersaClean Brush with Squeegee	Threaded	40225
36596	84	16" VersaClean Brush with Squeegee	Threaded	40225
<b>Window Squeegees</b>				
40069	45	14" Complete Strip Washer Head	Tapered/Threaded	40220
40070	46	12" Single-Blade Squeegee	Tapered - Telescopic	365408
40071	46	16" Single-Blade Squeegee	Tapered - Telescopic	365408
40072	46	8" Single-Blade Squeegee	Tapered - Telescopic	365408
40073	46	10" Double-Blade Squeegee	Tapered - Telescopic	365408
40074	46	14" Double-Blade Squeegee	Tapered - Telescopic	365408
41027	46	12" Double-Blade Squeegee	Tapered - Telescopic	365408
36281H	47	Plastic Handle Head for 36281CR Squeegees	Tapered/Threaded	40251
36283H	46	Stainless Steel Handle for 36283CR Squeegee	Tapered - Telescopic	365408
<b>Window Cleaning Brushes</b>				
3651	43	4-1/2" Round Window Brush	Flo-Thru/Threaded	40241
45350	43	4-1/2" Round Window Brush	Threaded	40261
361221	43	8" Flo-Thru Window Brush	Flo-Thru/Threaded	40241
361222	43	10" Flo-Thru Window Brush	Flo-Thru/Threaded	40241
<b>Brushes &amp; Accessories Handle Guide</b>				
<b>Flo-Thru Vehicle Brushes</b>				
36372	42	10" Flo-Thru Brush with Super Soft, Long, Fine Boar Bristles	Flo-Thru/Threaded	N/A
36466	41	10" Flo-Thru/ Brush with Flagged Polystyrene Bristles	Flo-Thru/Threaded	40241
36467	41	10" Flo-Thru/ Brush with Tampico Mix Bristles	Flo-Thru/Threaded	40241
36468	41	10" Flo-Thru/ Brush with Flagged Nylex Bristles	Flo-Thru/Threaded	40241
36497	42	10" Flo-Thru Vehicle Wash Brush with Flagged Polystyrene Bristles	Flo-Thru/Threaded	40241
40050	41	9-1/2" Flo-Thru Brush with Flagged Nylex Bristles	Flo-Thru/Threaded	40241
361209	41	9" Vehicle Wash Brush with Polystyrene Bristles	Flo-Thru/Threaded	40241
361252	41	10" Vehicle Wash Brush with Polystyrene Bristles	Flo-Thru/Threaded	40241
361297	42	10" Flo-Thru Vehicle Wash Brush with Nylex Bristles	Flo-Thru/Threaded	40241
3621997	42	10" Dual Surface Vehicle Brush with Polystyrene Bristles	Flo-Thru/Threaded	40241
<b>Non-Flo-Thru Vehicle Brushes</b>				
361214	40	14" Vehicle Wash Brush with Nylex Bristles	Threaded/Telescopic	365420
361228	40	8" Vehicle Wash Brush with Crimped Polypropylene Bristles	Threaded/Telescopic	365408

# HANDLE GUIDE

Item	Page	Description	Type of Handle	Recommended Handle
361230	40	10" Vehicle Wash Brush with Crimped Polypropylene Bristles	Threaded/Telescoping	365408
361234	40	14" Vehicle Wash Brush with Flagged Polystyrene Bristles	Threaded/Telescoping	365420
<b>Dusters &amp; Accessories</b>				
36111	50	Wall & Fan Brush with PVC Bristles	Threaded/Telescoping	365408
363401	50	Wide Wall Duster with PVC Bristles	Threaded/Telescoping	365408
363404	50	Round Duster with Soft Flagged PVC Bristles	Threaded/Telescoping	365450
<b>FoodService &amp; Equipment Handle Guide</b>				
<b>Tank &amp; Kettle Cleaning</b>				
40040/40041	18/18	5-1/2" x 7-1/2" Flare Head Brush with Polyester Bristles	Threaded	40225
40042	18	Tank & Kettle Brush	Threaded	40230
40043	18	Tank & Kettle Brush	Threaded	40230
40045	18	Vat & Cylinder Brush – 6" D	Threaded	40230
41002	18	Vat & Cylinder Brush – 7" D	Threaded	40230
41045	18	Vat & Cylinder Brush – 5" D	Threaded	40230
41177/41220	18/18	6" x 10-1/2" Jumbo Tanker with Polyester Bristles	Threaded	40225
41200	18	2" x 7-1/2" Round Tank Brush with Polyester Bristles	41296	41296
<b>Oven &amp; Grill Brushes</b>				
40026	32	30" Broiler Master	Threaded	020-30B*
40290	32	30" Broiler Master	Threaded	020-30B*
40291	32	8-1/2" Oven Brush & Scraper	Threaded	40275
40293	32	10" Pizza Oven Brush	Threaded	40275
41520	32	42" Oven Brush & Scraper	Threaded	020-40*
<b>FoodService Cleaning &amp; Prep</b>				
40360	22	4-1/2" x 7-1/2" Polyethylene Replacement Paddle Scraper Blade	Female Threaded	41450
40361	22	4-1/2" x 7-1/2" Nylon Replacement Paddle Scraper Blade	Female Threaded	41450
40362	22	6-1/2" x 9" Nylon Replacement Paddle Scraper Blade	Female Threaded	41450
365380	77	9-1/4" Pad Holder Handle Style	Threaded	40210

\*Replacement part, please contact your Customer Service Representative for more information.

## HOT STAMPING

Available for Bronco, TrimLine and 50 gal Rolling Waste Containers shown on pages 154-155, 157 & 159.

**Lead Time** - 4 weeks from receipt of approved artwork.

**Imprint Charge** - \$2.00 net each piece, per side.

**Artwork Charge** - One-time art and plate charge ranging up to \$780.00 net.

**Available Ink Colors** - Black, White

For reorders, please allow 10 working days.

### Bronco



Collar Imprint Area

Standard Belly Imprint Area

### TrimLine



Imprint Area

Prod No	Description	Max Imprint Shoulder H x W	Max Imprint Belly H x W	Min Order Qty
341010	10 gal Bronco Container	2" x 8"	7" x 9.25"	96 ea
341020	20 gal Bronco Container	2.5" x 8"	9" x 8.5"	96 ea
341032	32 gal Bronco Container	3.25" x 10"	11.5" x 13.5"	96 ea
341044	44 gal Bronco Container	3.25" x 10"	11.5" x 13.5"	96 ea
341055	55 gal Bronco Container	6" x 13"	14" x 13"	96 ea
345050	50 gal Rolling Container	—	10" x 10"	96 ea
342023	23 gal TrimLine Container	7.5" x 7.75" (Wide Side)	3" x 5.5" (Narrow Side)	96 ea

# BRISTLE MATERIAL GUIDE

Choose the best brush for your specific application. To prevent bacteria growth, synthetic materials are the best choice with high quality natural materials a good alternate. **Our fine selection of bristles offers you a choice of solutions for any application.**

## SYNTHETIC BRISTLES

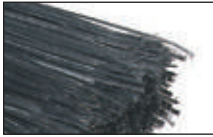

**Synthetic Corn** – Excellent chemical resistance. X-shaped bristle allows for superior sweeping on carpeting and entry mats. Ability to sweep liquids and dry debris. Superior longevity versus natural corn. Sustains temperatures up to 225°F.



**Synthetic Palmyra** – An ideal substitute with all the inherent properties of natural Palmyra. Bristle material has superior chemical resistance to acids, oil, fungus, and bacteria growth and withstands temperatures up to 225°F. A superior alternative that exceeds natural bristle performance.



**Nylon** – Excellent abrasion resistance, shear/break strength, and bristle bend recovery. Very good chemical resistance and sustains temperatures up to 350°F. Best choice for abrasive, rough use.

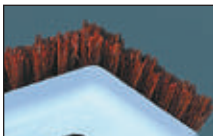

**Nylon Grit** – Nylon Filament with silicon carbide in each bristle is designed for use in general light scrubbing to heavy-duty scrubbing and stripping. Nylon Grit cleans floors faster and reaches into grout lines for thorough cleaning.



**Aggressive Nylon Grit** – An extra aggressive Nylon filament bristle material with Silicon Carbide Grit for scrubbing of heavily soiled floor surfaces.



**Polyester** – Excellent chemical resistance, ultra violet light resistance, and bristle bend recovery. Very good abrasion resistance and tear/break strength. Sustains temperatures up to 350°F. Best choice for all around use and for extreme exposure to cleaning chemicals.



**Polypropylene** – Excellent chemical resistance to acids, oils, fungus, and bacteria growth. Good abrasion resistance and shear/break strength. Sustains temperatures up to 225°F. Best choice as an economical synthetic foodservice alternative to natural fibers.



**Flagged Polystyrene** – A specially treated type of Polystyrene that has excellent bristle bend recovery and tear/break strength. Very good chemical resistance and fine bristle tip design resists matting for use up to 180°F. Best choice for floor sweeps and brooms.



**Polystyrene** – Has excellent bristle bend recovery and tear/break strength. Very good chemical resistance for general use up to 180°F. Best choice for floor sweeps and brooms.

## NATURAL BRISTLES



**Horsehair** – A natural pointed tip, good shear/break resistance, and soft cleaning properties. A fine synthetic bristle is an ideal choice as an economic alternative to natural horsehair.

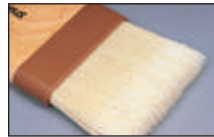

**Boar Bristle** – Bleached and sterilized bristles can withstand temperatures of up to 500°F. Double boiling process ensures integrity of bristles over long life. Natural taper and split ends of boar bristle make this one of the best choices for high heat basting.



**Bassine Fiber** – Natural stiff and coarse fibers from India palms is a classic choice for heavy floor cleaning.



**Bass Fiber** – Natural African Bass Fiber is coarse, stiff, and provides good flexibility for use in upright floor sweeps and as a blend with other fibers for other applications.

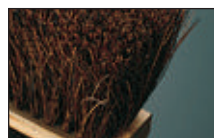

**Palmyra** – Natural medium stiff fibers from India palms is an excellent choice for general floor sweeps. Provides good durability and bristle recovery.



**Tampico** – Natural Tampico fiber from the Mexican agave plant is a soft to medium soft bristle with very good durability. A medium synthetic bristle is an ideal choice as an alternative for natural Tampico.



**Stainless Steel Wire** – Rust-proof, excellent chemical resistance, excellent bend recovery, provides a high degree of abrasion and wear resistance. Best foodservice choice for aggressive cleaning on grills and other heavily soiled foodservice equipment.



**Carbon Steel Wire** – Provides a high degree of abrasion and wear resistance. Good bend recovery. Best choice for aggressive cleaning on grills and other heavily soiled equipment.



**Brass Wire** – Rust resistant; provides a high degree of abrasion but is softer than stainless steel or carbon steel to prevent equipment damage. For use on ovens, griddles, and other metal equipment that is heavily soiled but cannot sustain heavy scratches.

# PLANT SANITATION GUIDE

The FDA has identified the need for a well organized and properly implemented sanitation program. It emphasizes the need for a clean plant environment extending from receiving areas to packaging rooms, and from floor to ceiling.

A critical element in this program is the proper selection, use and care of brushes. Brushes should be restricted to their particular zone of use. Brushes should be maintained in good condition, properly stored when not in use and sanitized between uses.

Sparta's Color-Coded Brush Program is the key to keeping brushes in the areas they are used, doing the jobs they are meant to do.

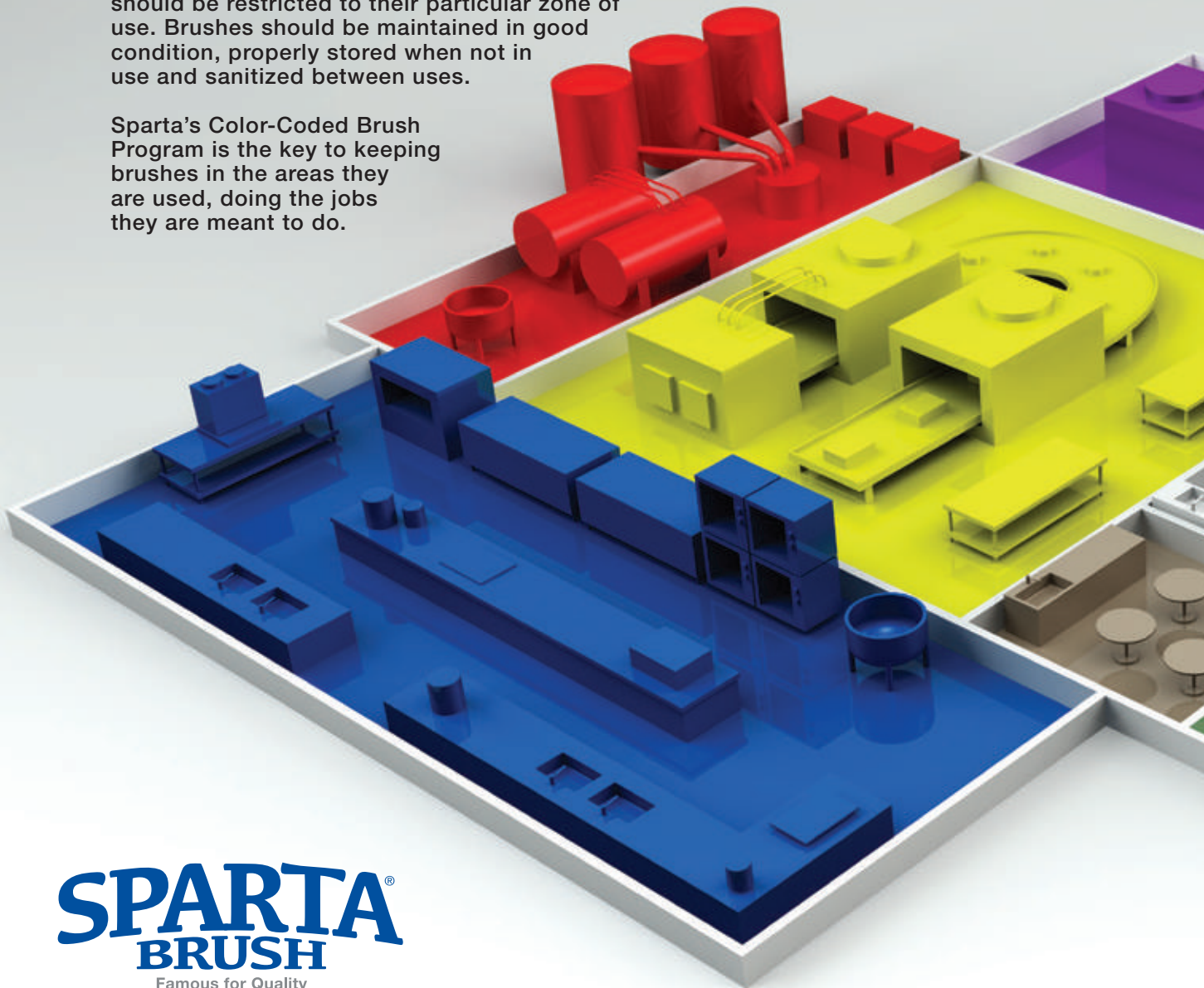

**SPARTA<sup>®</sup>**  
**BRUSH**  
Famous for Quality





### Suggested Color Usage

- Receiving/Raw Material
- QC Lab/Test Kitchen
- Processing
- Processing
- Employee Lounge
- Restroom
- Office
- Warehouse

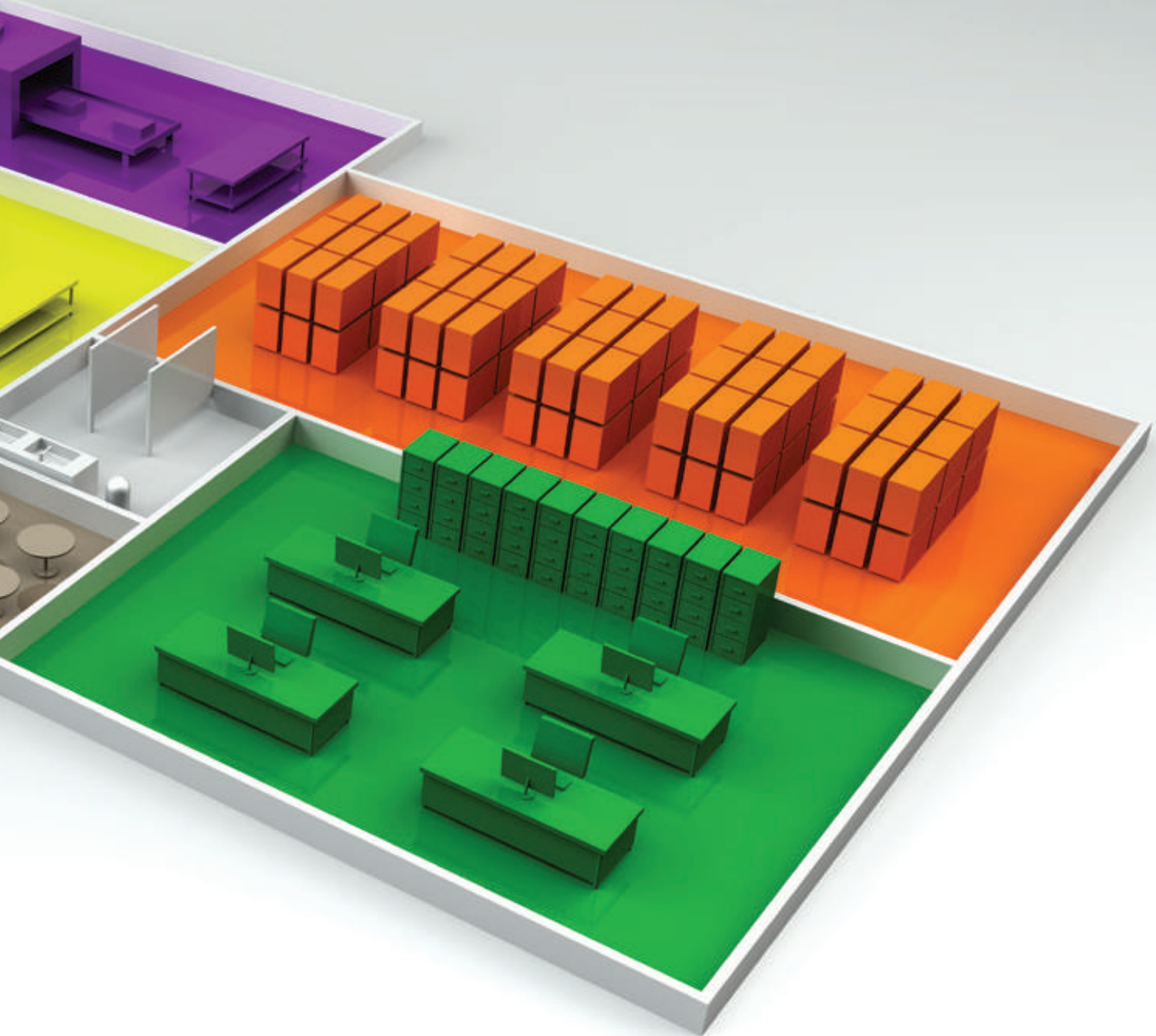

# CHEMICAL BRUSH TIE-IN

Cleaning Activity	Chemical Exposure/ Specific Use	Product Description	Product #	Notes
Beverage Service and Manual Dishwashing	Coffee, Vinegar, Alcohol, Iodine, General Purpose Cleaner	Carafe/Bottle Brush	4000002	Other colors available Other variations available Other variations available
		Coffee Decanter Brush	4150600	
		Glass Washing Brushes	4002500	
	Pot and Pan Detergent, Degreaser, Quart Sanitizer	12" Dishwash Brush 8" Dish/Sink Brush	4041300 361014000	
Drains, Washroom, and Hygiene	Bowl Cleaner	17" No Splash Polyester Bowl Brush	4014000	Other sizes available Other sizes available Low cost alternative Brush only also available
		14.5" Bowl Brush with Caddy	36719700	
	Drain Cleaner	3" Drain Brush Head	4014600	
		36" Drain Brush Handle	4023600	
	Hand Soap	3.5" Hand & Nail Brush	3623900	
		5" Hand & Nail Brush Kit	4002100	
Floor Sweeping	Dust Mopping	Wedge Mop with 60" Handle	4167500	Other handles available  Other colored handles available Other variations available Other sizes and styles available  *Note: Uses 4022514 Flex Tip Fiberglass Handle **Note: 36" Omni Sweep uses 4527000 Anchor Style Handle
		60" Snap On Swivel Dust Mop Handle	4585000	
	Host Stand	Duo-Pan Combo	36141503	
		Small Area General Clean-Up	Duo-Sweep™ Lobby Angle Broom Flagged	
	Duo-Sweep™ Medium Duty Angle Broom Flagged		3686500	
	Duo-Sweep™ Heavy Duty Angle Broom Unflagged		3688500	
	Duo-Sweep 9" Light Flagged		3686314	
	Sweeping Compound/Large Area General Clean-up	Duo-Sweep 9" Light Stiff Unflagged	3686403	
		Omni Sweep™ 18" Plastic Block*	4188000	
			Omni Sweep™ 24" Plastic Block*	
Omni Sweep™ 36" Wood Block**		4187200		
Food Prep	Fruit & Veggie Wash	Vegetable Brush	4016402	Other variations available
Hard Surface Clean-up and Sanitizing	All Purpose Cleaner, Peroxide Cleaner, Quart Sanitizer	20" Utility Scrub with Polyester Bristles	4050102	All available in six colors; do not use w/chlorine or strong alkaline degreasers
		6" Cutting Board Brush	4052102	
		8" Utility Scrub with Polyester Bristles	4054102	
Pastry/Basting Brushes	Butter, Oils, Acidic Sauces (tomato based)	12" Handle, 4" Wide Boar Bristle Basting Brush	4037100	Other sizes and bristle materials available
		2" Wide Nylon Bristle Brush	4039700	
Window Washing	Window Cleaner	12" Single Blade Window Squeegee	4007000	
		14" Strip Washer	4006900	
		14.88" Washer Squeegee	36286800	
Oven, Grill, Hood, Fryer Cleaning	Degreaser, Fryer Cleaner and Oven Cleaner	20" Utility Scrub	4011300	Should rinse after use as prolonged exposure to strong alkaline cleaning chemicals will cause deterioration Low cost alternative Low cost alternative
		24" Looped Fryer Brush with 2" Bristles	4011200	
		28" Straight Utility Brush with 1.38" Bristles	4011000	
		30" Double Broiler King Wire Brush w/Handle	4029400	
		8" Brush w/Palmyra Bristles	3651300	
		20" Brush w/Palmyra Bristles	36513L00	



Cleaning Activity	Chemical Exposure/ Specific Use	Product Description	Product #	Notes
Wet Mopping, Floor Scrubbing, and Spill Management	Deck Wash, Degreaser, Quarry Tile Shock	8" Swivel Scrub w/DuPont Nylon Grit Bristles Hi-Lo™ Deck Scrub	36531027 4042302*	Do not use with acid. Use handle 4027100 or 4028500
	Floor Cleaner, All Purpose Mop Head	#24 Large 4-ply Cotton Cut End	369824B00	Low cost alternative
	Cleaner, General Cleaner; General Purpose Mopping and Spill Management	Large 4-ply Looped End Synthetic Cotton Blend Mop	369424B00	Other sizes available
	Floor Finish	Large 4-ply Looped End Rayon Blend Finishing Mop	369670B14	Other sizes available
		Quik-Release™ Yellow Mop Handle	4166404	Other colors available
		Quik-Release™ Metal Mop Handle	36959500	
	Floor Stripper	#24 Large 4-ply Cotton Cut End Mop	369824B00	Low cost alternative
	Safety Products	Wet Floor Sign	3690000	
	Squeegees	24" Plastic Hygienic squeegee	4156802	Other colors available
		24" Threaded Handle, Metal Frame Squeegee	36682400	Other sizes available
		30" Red Foam Rubber, Fat and Oil Resistant, Squeegee	36653000	Other sizes available
	Tile & Grout Cleaner	Swivel Head Grout Line Brush 8-1/8" Toothbrush Style Grout Brush Unique Design Tile & Grout Brush	36532003 36535103 4132302	Do not use with acid Use handle 4027100 or 4028501
	Upholstery & Carpet Spotting Chemical	Carpet/Upholstery Spotting Brush	4139502	

\*Note: Other colors available

# SOLVENT & CHEMICAL RESISTANCE

## Introduction

Solvent and chemical resistance refers to the ability of a fiber to retain its important physical properties. The resistance of fibers to chemicals depends not only on the type of fiber and the chemical, but concentration, temperature, time, fiber diameter, stress, etc. The following are general comments on solvent and chemical resistance, followed by a more specific table.

## Material Information

### Nylon

Nylon has excellent resistance to most substances. It is however attacked by oxidizing agents, organic acids, mineral acids and aromatic alcohols. Nylon has excellent resistance to hydrocarbons (such as gasoline, kerosene and diesel fuel), oils, cleaning solutions and alkalis. It will absorb small amounts of water, low molecular weight alcohols (methyl, ethyl or isopropyl alcohols) and chlorinated solvents and be plasticized to them.

### Polyester

Polyester has excellent resistance to most substances. It is resistant to acids, oxidizers such as hydrogen peroxide and most solvents. Polyester has excellent resistance

to hydrocarbon fuels, oils and lubricants. It is however attacked by strong alkalis such as concentrated solutions of sodium hydroxide (lye or caustic soda), calcium hydroxide (lime, mortar), ammonia, trisodium phosphate or sodium carbonate (washing soda, soda ash).

### Polypropylene

Polypropylene offers excellent resistance to most water soluble chemicals, including fairly strong acids or alkalis and simple hydrocarbons. It may be attacked by oxidizing agents such as hydrogen peroxide, chlorinated solvents such as 1,1,1-trichloroethane and aromatic solvents such as xylene, especially at higher temperatures.

## Ratings

**S: Satisfactory** – The material should give good service life when used with this chemical.

**M: Marginal** – Depending on temperature concentration, exposure, expected life, etc. The material may or may not give adequate performance. Specific testing for the application is recommended, or contact us for further details.

**U: Unsatisfactory** – The material will deteriorate in hours to weeks when used with this chemical.

REAGENT	POLYPROPYLENE	NYLON	POLYESTER	NOTES
Acetaldehyde	M	M	M	—
Acetic Acid 5%	S	M	S	Will etch Nylon
Acetic Acid 10%	S	M	S	—
Acetic Acid 100%	S	U	U	Will dissolve Nylon
Acetone	S	S	M	—
Acetophenone	S	S	—	—
Allyl Alcohol	—	S	S	—
Aluminum Chloride	S	M	S	—
Aluminum Sulfate	S	S	S	—
Ammonia Solution	S	S	S	aka Ammonium Hydroxide
Amyl Alcohol	S	S	S	—
Amyl Acetate n-	S	S	S	—
Amyle Chloride	M	—	—	—
Anti-Freeze	S	S	S	—
Aqua Regia	S	U	U	—
Aromatic Hydrocarbons	U	S	M	—
Barium Carbonate	S	S	S	—
Benzaldehyde	M	S	—	—
Benzene	U	S	M	—
Benzoic Acid	S	S	S	—
Benzyl Acetate	M	—	—	—
Borax	S	S	S	—
Boric Acid	S	S	S	—
Brake Fluid	—	S	S	—
Bromine Liquid	M	U	U	—
Butanol	S	S	S	—
Butter	S	S	S	—
Butyl Acetate iso	S	S	M	—
Butyl Acetate n-	S	S	M	—
Butyl Alcohol iso	S	S	S	—
Butyl Alcohol n-	S	S	S	—
Butyl Phthalate	S	S	S	—
Calcium Chloride	S	U	S	—
Calcium Hypochlorite 15%	S	U	S	—
Camphor	U	S	—	—

REAGENT	POLYPROPYLENE	NYLON	POLYESTER	NOTES
Carbon Tetrachloride	U	S	S	—
Carbolic Acid 50%	S	U	U	aka Phenol/ Solvent for Nylon
Carbolic Acid 100%	S	U	U	aka Phenol/ Solvent for Nylon
Caster Oil	S	S	S	—
Caustic Soda	S	M	M	aka Sodium Hydroxide
Cellosolve	S	—	—	—
Cellulose Acetate	S	S	—	—
Cetyl Alcohol	S	S	S	—
Chlorobenzene	U	S	M	—
Chloroform	U	M	M	Temporarily softens Nylon
Chlorine	U	U	U	—
Chromic Acid	S	U	M	—
Citric Acid 10%	S	M	S	—
Citric Acid 20%	S	M	S	—
Citrus Oil	S	S	S	—
Cocoa Butter	S	S	S	—
Cod Liver Oil	S	S	S	—
Coconut Oil	S	S	S	—
Copper Salts	M	M	M	—
Corn Oil	S	S	S	—
Cottonseed Oil	S	S	S	—
Cyclohexane	M	S	S	—
Cyclohexanol	S	S	—	—
Cyclohexanone	M	S	—	—
Decalin	U	S	M	—
Detergents	S	S	S	—
Diacetone	S	M	U	—
Dibutyl Sebacate	S	—	—	—
Dichlorobenzene p-	—	S	—	aka Moth Balls
Diethylene Glycol	S	M	M	—
Diethylketone	S	M	U	—
Dimethyl Formamide	S	M	S	—
Epichlorohydrin	S	M	—	—

REAGENT	POLYPROPYLENE	NYLON	POLYESTER	NOTES	REAGENT	POLYPROPYLENE	NYLON	POLYESTER	NOTES
Ether	S	S	S	—	Ozone	M	M	M	—
Ethyl Acetate	M	S	M	—	Paint Thinner	M	S	S	aka VM & P naphtha
Ethyl Alcohol 95%	S	S	S	Temporarily softens Nylon	Palm Oil	S	S	S	—
Ethyl Chloride (Gas & Liq.)	M	S	—	—	Palmitic Acid	S	S	S	—
Ethyl Ether	S	S	S	—	Peanut Oil	S	S	S	—
Ethylene Lactate	—	M	—	—	Pectin	S	S	S	—
Ethylene Dichloride	M	S	M	—	Perchloroethylene	U	S	—	—
Ethylene Glycol	S	S	S	—	Petroleum Distillate	M	S	S	—
Ethylene Oxide	M	M	S	—	Petroleum Jelly	S	S	S	—
Ferrous Chloride	S	U	S	—	Phenol 5%	S	U	U	Solvent for Nylon
Formaldehyde	S	S	S	—	Phosphoric Acid 50%	S	U	S	—
Formic Acid	S	U	S	Solvent for Nylon	Potassium Hydroxide 30%	S	S	U	—
Furfuryl Alcohol	M	S	S	—	Potassium Hydroxide 35%	S	S	U	—
Gasoline	M	S	S	—	Potassium Hydroxide 50%	S	M	U	—
Glucose 30%	S	S	S	—	Potassium Bromide	S	S	S	—
Glycerin	S	M	S	—	Potassium Ferricyanide	S	S	—	—
Heptyl Alcohol n-	—	M	—	—	Potassium Iodide	S	—	—	—
Hexane	M	S	S	—	Potassium Permanganate	M	U	S	—
Hexyl Alcohol n-	—	M	—	—	Potassium Thiocyanate	S	U	S	—
Hydrochloric Acid 10%	S	U	S	Dissolves Nylon	Propyl Alcohol iso-	S	M	M	—
Hydrochloric Acid 38%	S	U	M	Dissolves Nylon	Propylene Glycol	S	S	S	—
Hydrofluoric Acid	S	U	U	—	Resorcinol	—	U	—	Solvent for Nylon
Hydrogen Peroxide 3%	S	U	S	—	Salicylic Acid	S	S	M	—
Hydrogen Peroxide 30%	M	U	S	—	Silver Nitrate	S	S	S	—
Hydroquinone	S	U	S	—	Sodium Acetate	S	S	S	—
Iodine Tincture	S	U	—	—	Sodium Benzoate	S	S	S	—
Isopropyl Alcohol	S	S	M	—	Sodium Bicarbonate	S	S	S	—
Derosene	M	S	S	—	Sodium Bisulphite	S	S	S	—
Lactic Acid 10%	S	M	S	—	Sodium Borate	S	S	S	—
Lanolin	S	S	S	—	Sodium Bromide	S	S	S	—
Lard	S	S	S	—	Sodium Carbonate	S	S	S	—
Lauryl Alcohol	S	S	S	—	Sodium Chloride	S	S	S	—
Lemon Juice	S	M	S	—	Sodium Dichromate 10%	S	M	M	—
Lubricating Oil	S	S	S	—	Sodium Hydroxide 40%	S	M	U	—
Lye	S	M	M	—	Sodium Hypochlorite 5%	M	U	M	aka bleach
Magnesium Carbonate	S	S	S	—	Sodium Tetraborate	S	S	M	aka Borax
Maleic Acid 10%	S	S	S	—	Sodium Thiosulfate	S	S	S	aka Hypo
Mercuric Chloride 5%	S	U	—	—	Stannic Chloride	S	M	—	—
Methyl Acetate	M	S	M	Temporarily softens Nylon	Stearic Acid (pwd.)	S	S	S	—
Methyl Alcohol	S	S	S	Temporarily softens Nylon	Stoddard Solvent	M	S	S	—
Methyl Chloride	M	—	—	—	Sucrose 30%	S	S	S	—
Methyl Ethyl Ketone	M	S	M	Softens Nylon	Sulphuric Acid 2%	S	M	S	—
Methyl Isobutyl Ketone	M	S	U	—	Sulphuric Acid 50%	S	U	U	—
Methyl Propyl Ketone	M	S	U	—	Sulphuric Acid 96%	S	U	U	—
Methyl Salicylate	—	—	—	aka Oil of Wintergreen	Tannic Acid 2%	S	—	S	—
Methylene Chloride	M	M	U	—	Tartaric Acid	S	S	S	—
Milk	S	S	S	—	Tea (sol.)	S	S	S	—
Mineral Oil	M	S	S	—	Tetrahydrofuran	S	S	S	—
Monochlorobenzene	U	S	M	—	Tetralin	M	S	S	—
Motor Oil	S	S	S	—	Thionyl Chloride	—	U	—	—
Nitric Acid	M	U	M	—	Toluene	M	S	M	—
Nonyl Alcohol	S	S	S	—	Trichloroethylene (1,1,1)	U	S	S	Softens Nylon
Octyl Alcohol	S	S	S	—	Trisodium Phosphate	S	S	M	—
Oils-Essential	M	S	S	—	Triethylene Glycol	S	S	S	—
Oils-Vegetable	S	S	S	—	Turpentine	M	S	S	—
Oleic Acid 100%	S	S	S	—	Water	S	S	S	—
Orange Juice Fresh	S	S	S	—	Water Carbonated	S	S	S	—
Orange Juice Conc.	S	S	S	—	Xylene	M	S	M	—
Oxalic Acid 10%	S	M	S	—	Zinc Chloride	S	U	S	—
					Zinc Salts in solution	S	U	S	Cracks Nylon
					Zinc Stearate	S	S	S	—

# PRODUCT INDEX

Prod No	Page No	Prod No	Page No	Prod No	Page No	Prod No	Page No
11828	39	341541	156	344057REC	163	361222	43
11829	39	341542	156	344058	159	361228	40
11830	39	342015	157	345050	159	361230	40
11831	39	342015REC	163	345050REC	163	361234	40
11832	39	342023	157	346144	160	361250	43
11833	39	342023CMP	163	346145	160	361252	41
2710	173	342023REC	163	346146	160	361297	42
341010	154	342024	157	34RECLBL	162, 163	3612PD	110
341010ICE	155	342025	157, 163	3601236	71	3612VBK	110
341010IMB	155	342026REC	163	3602418	71	3612VRD	110
341011	154	342027REC	163	3602424	71	3612VWH	110
341020	154	342913	161	3602436	71	3613B	17
341020IMB	155	342913REC	163	361006	48	3613PD	110
341020INE	155	342915	161	3610136	48	3613S	17
341020REC	162	342927	161	3610140	31	3613VBK	110
341020USD	155	342928	161	3610150	48	3613VRD	110
341021	154	342928REC	163	36102218	70	3613VWH	110
341021REC	162	342940	161	36102224	70	361410	63
341032	154	342941	161	36102236	70	36141003-1	63
341032INE	155	342941REC	163	361040	40	361412	62
341032REC	162	343021	158	36107624	72	361415	62
341032TRA	155	343021REC	162	36111	50	361416	62
341032USD	155	343022	158, 162	361116	73	36142003	63
341033	154	343122	158	361118	73	361437	63
341033REC	162	343123	158	361124	73	3614PD	110
341034	154	343124	158	36113016	73	3614VBK	110
341035	154	343523	158	36113018	73	3614VRD	110
341044	154	343523REC	162	36113024	73	3614VWH	110
341044INE	155	343525	158	36114016	73	36150	12
341044REC	162	343526REC	162	36114018	73	3615PD	110
341044TRA	155	343527REC	162	36114024	73	3615VBK	110
341044USD	155	343935	158	3611PD	110	3615VRD	110
341045	154	343935REC	162	3611VBK	110	3615VWH	110
341045REC	162	343936REC	162	3611VRD	110	361600	95
341055	154	343937REC	162	3611VWH	110	361603	95
341056	154	343950	158	3612018	83	3616PD	110
341057	154	343950REC	162	3612024	83	3616VBK	110
341132	154	343951	158	3612036	83	3616VRD	110
341144	154	344042	159	361209	41	3616VWH	110
341528	156	344056	159	361214	40	36175	75
341529	156	344056REC	163	36122	13	3617PD	110
341540	156	344057	159	361221	43	3617VBK	110

Prod No	Page No	Prod No	Page No	Prod No	Page No	Prod No	Page No
3617VRD.....	110	36219618.....	65	36333.....	39	3647548.....	86
3617VWH.....	110	36219624.....	65	36334.....	39	3648824.....	85
3618PD.....	110	36219663.....	76	3633519.....	87	3648836.....	85
3618VBK.....	110	3621997.....	42	3633525.....	87	36490.....	86
3618VRD.....	110	362208P18.....	69	3633537.....	87	36490R.....	86
3618VWH.....	110	362208P24.....	69	3633670.....	87	36497.....	42
36190.....	74	362218.....	70	36336C.....	82	365009.....	14
36191.....	75	362224.....	70	363401.....	50	365015.....	14
36192.....	75	362236.....	70	363404.....	50	36505.....	10
36193.....	75	36225.....	12	36372.....	42	36505L.....	10
36193MX.....	75	36232.....	48	363725.....	32	36506.....	10
36193P.....	75	36233.....	48	363744.....	49	36506L.....	10
361966.....	78	36236.....	63	36380.....	12	36509L.....	11
36197.....	74, 155	36238.....	48	3638831.....	76	3651.....	43
3619PD.....	110	36238C.....	48	36395.....	75	365108.....	47
3619VBK.....	110	36239.....	14	36397.....	79	365117.....	44
3619VRD.....	110	36257N.....	15	36399.....	63	365119.....	44
3619VWH.....	110	36257WN.....	15	36400.....	63	365120.....	44
3620016.....	102	36258.....	13	364105.....	101	36513.....	11
3620055.....	102	36259.....	13	364108BD.....	111	36513L.....	11
3620058.....	102	36275.....	75	364112BD.....	111	365150.....	106
3620104.....	102	36277.....	15	364148BD.....	111	365160TC.....	67
3620125.....	102	36281CR16.....	47	364192BD.....	111	365300.....	76
362013.....	101	36281H.....	47	364192REZ.....	111	365310.....	76
362018.....	70	36283CR18.....	46	364200BD.....	111	365320.....	77
3620194.....	58, 59, 104	36283H.....	46	364200REZ.....	111	365351.....	77
362024.....	70	362868.....	47	36424T.....	105	365380.....	77
3620275.....	104	36289.....	15	3643418.....	68	365408.....	105
3620294.....	58, 59, 104	36292.....	75	3643424.....	68	365414.....	105
362036.....	70	36293P.....	75	3643436.....	68	365420.....	105
3620405.....	102	36297.....	79	364386.....	49	365450.....	50
36204818.....	68	36313.....	48	36439.....	49	365501.....	44
36204824.....	68	363156.....	51	364391.....	49	36552.....	20
36207218.....	72	363157.....	51	36447.....	40	36560.....	20
36207224.....	72	36324C.....	82	36466.....	41	36567.....	82
3620PD.....	110	3633.....	48	36467.....	41	36568.....	82
3620VBK.....	110	3633019.....	45, 87	36468.....	41	36573.....	43
3620VRD.....	110	3633118.....	85	3647248.....	86	36592.....	84
3620VWH.....	110	3633124.....	85	3647324.....	86	36596.....	84
36211.....	13	3633136.....	85	3647336.....	86	366024.....	83
362113.....	101, 103	3633218.....	85	3647524.....	86	366036.....	83
36219416.....	73	3633224.....	85	3647536.....	86	366124.....	83

# PRODUCT INDEX

Prod No	Page No	Prod No	Page No	Prod No	Page No	Prod No	Page No
36620	9	36864	59	36945	97	40020	14
36620L	9	36865	58	369454B	90	40021	14
366222	81	36867	58	369460	90	40024	15, 53
366224	71	36868	58	36947	97	40025	30
366230	81	36873	59	369472B	90	40026	32
366318	80	36874	59	369475	101	40027	33
366324	80	36883	59	369478B	90	40028	30
36633	60	36884	59	369484B	90	40040	18
366330	80	36885	58	36949	97	40041	18
36634	61	36900	97	369524	73	40042	18
366530	80	369024C	94	369550B	90	40043	18
366724	80	369024R	94	369551B	90	40045	18
366824	80	36904	96	369552B	90	40050	41
366918	81	36905	96	369595	100	40069	45
366922	81	369066B	93	369670B	92	40070	46
366930	81	369070B	93	369674B	92	40071	46
367197	49	369074B	93	36968	100	40072	46
3672231	155	36908	96	36970	101	40073	46
367360TC	66	369082	93	369724	93, 94	40074	46
367366TC	66	36908C	96, 171	369732	93, 94	40075	83
367372TC	67	36908W	96	369811B	92	40076	83
367378TC	67	36909	97	369814B	92	40077	83
367382TC	66	36910	155	369816B	92	40078	82
367386TC	66	36911	155	369817B	92	40081	80
367390TC	67	36920-1	157	369819B	92	40082	80
367394TC	67	369320	91	369820B	92	40083	80
367395TC	67	369365	100	369824B	92	40095	45
367396TC	66	369375	100	369832	92	40107	80
367600TC	31	36940	97	36990	95	40108	80
367618	72	36941	97	36990R	95	40109	80
367624	72	369412B	90	36P5	48	40110	27
367818	81	369413B	90	36P74BD	111	40111	27
3681	60	369418B	90	40000	19	40112	27
3682	60	369419B	90	40001	19	40113	38
36846	13	36942	97	40002	19	40114	38
36853	59	369420	91	40003	19	40115	38
36854	59	369424B	90	40004	19	40116	27
36855	60	369425B	90	40005	19	40140	48
36859	59	369430	90	40006	19	40144	78
36860	59	36944	97	40007	19, 53	40146	53, 78
36861	58	369442B	90	40008	19	40147	78
36863	59	369448B	90	40010	19	40148	78



Prod No	Page No	Prod No	Page No	Prod No	Page No	Prod No	Page No
40150.....	20	40305.....	95	40403.....	37	40672.....	33
40152.....	20	40306.....	95	40405.....	37	40673.....	30
40153.....	30	40340.....	100	40412.....	37	40674.....	17
40154.....	20, 30	40345.....	94, 101	40413.....	31	40675.....	17
40155.....	20	40347.....	22	40415.....	29	40679.....	19
40156.....	20	40349.....	22	40421.....	74	40704.....	38
40157.....	20	40350.....	22	40422.....	74	40710.....	33
40160.....	20	40351.....	22	40423.....	74, 53	40711.....	33
40164.....	37	40352.....	22	40424.....	17	40712.....	33
40176.....	21	40353.....	22	40425.....	17	40713.....	33
40180.....	20	40354.....	22	40430.....	76	40724.....	77
40181.....	20	40355.....	22	40460.....	28	40725.....	77
40182.....	20	40356.....	22	40461.....	28	40728.....	31
40183.....	20	40357.....	22	40462.....	28	40729.....	31
40210.....	103	40359.....	22	40465.....	28	40731.....	107
40220.....	103	40360.....	22	40466.....	29	40732.....	107
40223.....	104	40361.....	22	40467.....	29	40733.....	107
40224.....	104	40362.....	22	40468.....	29	40735.....	53, 107
40225.....	53, 64, 103	40370.....	34	40469.....	29	40737.....	107
40227.....	103	40371.....	34	40470.....	29	41002.....	18
40230.....	105	40372.....	34	40480.....	12, 53	41003.....	11
40232.....	105	40373.....	34	40481.....	13	41014.....	105
40233.....	105	40374.....	34	40485.....	12	41020.....	103, 105
40236.....	78	40375.....	34	40500.....	9	41027.....	46
40237.....	78	40376.....	34	40501.....	8, 53	41040.....	22
40238.....	78	40377.....	34	40520.....	14	41045.....	18
40241.....	104	40378.....	35	40521.....	14, 25	41076.....	24
40250.....	105	40379.....	35, 53	40529.....	30	41077.....	24
40251.....	105	40380.....	34	40532.....	30	41078.....	79
40261.....	102	40390.....	36	40540.....	9	41082.....	58
40262.....	102	40391.....	36	40541.....	8, 53	41083.....	53, 58
40267.....	102	40392.....	36	40542.....	9	41093.....	78
40271.....	102	40393.....	36	40545.....	8	41100.....	24
40275.....	102	40394.....	36	40546.....	8	41101.....	21
40281.....	102, 106	40395.....	35	40561.....	68	41102.....	21
40285.....	102	40396.....	35	40562.....	68	41105.....	21
40290.....	32	40397.....	35	40564.....	69	41109.....	21
40291.....	32	40398.....	35	40565.....	69	41110.....	21
40293.....	32	40399.....	35	40634.....	60	41114.....	21
40294.....	32	40400.....	35	40650.....	58	41121.....	21
40300.....	95	40401.....	35	40670.....	33	41131.....	21
40301.....	95	40402.....	35	40671.....	33	41132.....	21

# PRODUCT INDEX

Prod No	Page No	Prod No	Page No	Prod No	Page No	Prod No	Page No
41140	21	41460	29	45202	72	CC2036	167
41158	21	41506	28	45204	72	CC2036DP	167
41160	21	41520	32	45221	72	CC2036P	167
41164	21	41567	81	45222	72	CC2243	167
41165	105	41568	81	45224	72	CD2036	167
41169	27	41619	53, 79	45259	104	CP2036	167
41170	21	41664	100	45267	102	JC1945CB	171
41176	21	41672	86	45268	102	JC1945L	171
41177	18	41673	86	45270	64, 102	JC1945S	171
41180	21	41679	61	45280	106	JC1946	171
41184	21	41680	61	45282	106	N44010	172
41196	20	41683	61	45350	43	N44011	172
41197	20	41870	64	45411	13	N44012	172
41198	13	41871	64	45463	11	SBC11SH	168
41199	104	41872	64	45472	9	SBC11TC	168
41200	18	41880	64	45475	9	SBC1521	167
41220	18	41881	64	45493	11	SBC2031	167
41225	58, 59, 103	41890	64	45494	15	SBC230	168
41226	103	41891	53, 64	45500	14	SBCC240	167
41232	105	44010	173	45532	48	SBCC245	167
41263	20	44011	173	45571	33	TT005	165
41270	17	44012	173	45643	61	TT010	165
41271	21	45013	68	45649	61	TT105	165
41278	41	45014	68	45733	51	TT110	165
41291	103	45016	68	45743	50	TT175	165
41296	18	45030	68	45744	50	UC1940	169
41323	77	45031	68	45751	79	UC3031524	168
41349	60	45032	68	45770	16	UC3031827	168
41350	60	45040	70	45772	32	UC4018	169
41352	60	45041	70	45773	16	UC4031529	168
41354	60	45043	70	45776	16	UC4031733	168
41358	22	45051	69	45777	16	UC4525	169
41359	22	45053	69	45779	33	UC5031524	168
41372	12	45054	69	45796	17	UC5031827	168
41390	24	45056	69	45850	101	UC5032135	168
41395	15, 53	45072	69	991109	53	UC7022133	168
41396	15	45073	69	991119	53	UC7031524	168
41446	38	45074	69	991129	53	UC7031827	168
41447	23	45135	71	991139	53	UC7032133	168
41448	23	45136	71	991149	53		
41449	23	45196	64	CC11SH	167		
41450	23	45201	72	CC11TH	167		

# TERMS & CONDITIONS — SMP

## 1. Terms and Method of Payment

- a. All orders are subject to approval and acceptance by SELLER. No order accepted by SELLER shall be subject to cancellation, termination, suspension, change, reduction, cutback or other modification except with SELLER'S prior written consent.
- b. Our standard terms of payment are net 30 days from invoice date. The amount of terms of credit, if extended, may be changed or credit withdrawn by SELLER at any time. No orders will be shipped on a COD basis.
- c. Prices do not include federal, state or local taxes, duties or other levies, now or hereafter enacted, applicable to the items deliverable under the sales order or invoice (hereinafter called ITEMS), which taxes, duties, or other levies will be added by SELLER to the sales price and will be paid by BUYER unless BUYER provides SELLER with a proper exemption certificate.
- d. Packaging for commercial shipment is included in the contract price. Any special packaging, crating or shipping instructions must be noted on BUYER'S original order and acknowledged by SELLER.

## 2. Title and Delivery

The ITEMS shall be delivered F. O. B. SELLER'S plant, and title thereto shall pass to BUYER, upon SELLER'S delivery of the ITEMS to a common carrier for shipment to BUYER. Items from the Carlisle Sanitary Maintenance Products, Catalog, Carlisle Sanitary maintenance Products Industrial Catalog, and the Carlisle FoodService Products catalog may be combined to obtain prepaid freight, regardless of the shipping point. Freight is prepaid on all orders totaling \$1,500 net or more to one destination within the contiguous 48 United States. Freight on prepaid International Shipments will be paid on normal ground transportation from shipping point to the consignee. When the order qualifies for prepaid freight, Seller shall have the right to select the means of transportation. If Buyer requires a means of transportation other than the one normally selected by Seller, any extra cost incurred by reason of using such other means shall be paid by Buyer. Palletized international orders requiring heat treated pallets will be charged \$4.25 net per pallet. International orders requiring heat treated certified bark-free pallets will be charged \$18.50 net per pallet. Any accessorial charges incurred because of a customer request will be the responsibility of the requester. Any items backordered from a prepaid shipment will be forwarded prepaid. Items backordered from ex works shipments will be forwarded ex works.

## 3. Inspection and Acceptance

Thoroughly inspect all shipments. Do not accept a damaged or short shipment until exception is noted on the freight bill. BUYER will be held responsible for all shipments with freight bills signed free and clear. If concealed damage is discovered, contact the freight company immediately for inspection. Concealed damage must be reported to the carrier within 7 days of receipt. All damaged goods and shortages that are not properly documented and reported upon receipt become the sole responsibility of the BUYER.

## 4. Patent Indemnification

SELLER shall protect and indemnify BUYER and its directors, officers, agents and employees against all claims for damages or profits, including all reasonable costs incurred by BUYER in connection therewith, arising from infringement of patents, copyrights, trademarks or misappropriation of designs.

## 5. Returns and Cancellations

No returns will be accepted without an authorization number from Carlisle Customer Service. An authorization number may be obtained by calling 800 654 8210 and requesting a Return Authorization from Customer Service. All requests for return must occur within 90 days of the original shipment of the product unless special authorization is obtained. Merchandise returned without authorization will be refused and returned to the customer, freight collect. Any merchandise must be returned freight prepaid, and is subject to a minimum of 15% restocking charge. All returned goods must reference the original invoice and purchase order. Returned goods must be in original standard packs and in unused salable condition. Special Order Products and discontinued items will not be accepted for exchange or return. This includes any articles custom imprinted or modified for purchaser.

## 6. General

- a. All prices are list and subject to change without notice. Orders from authorized accounts will be accepted with the understanding that prices are those in effect at the time of shipment. These prices are exclusive of all sales taxes which may be levied by State, Federal, or City governments.
- b. Orders less than \$100.00 net will be charged a \$10.00 handling fee. The initial order requirement for a new customer is \$2,000 net, and must be accompanied by a tax exemption certificate.
- c. Orders calling for less than a standard case pack will be charged \$5.00 net each per broken case.
- d. Orders requiring 3rd party freight billing will be assessed a \$5.00 per order processing charge.
- e. All orders of custom products are subject to shipment of plus or minus 10% of the quantity ordered.
- f. No ITEMS to be furnished hereunder shall be exported by BUYER unless SELLER is first notified in writing of the intention to so export and all applicable regulations and licenses are complied with and obtained by BUYER or its customer.
- g. SELLER hereby certifies that the goods described herein of its manufacture will be produced in compliance with all applicable requirements of Sections 6, 7 and 12 of the Fair Labor Standards Act, as amended, and all order of the United States Department of Labor issued under Section 14 thereof. SELLER further certifies that it is in compliance with the Equal Employment Opportunity clause in Section 202, paragraphs 1 through 7 of Executive Order 11246, as amended, relative to equal employment opportunity and the implementing Rules and Regulations of the Office of Federal Contract Compliance.
- h. SELLER is not responsible for typographical errors made in any of its publications or for stenographic or clerical errors made in preparation of quotations, sales orders, acknowledgments, or invoices. All such errors are subject to correction.
- i. This agreement shall be governed by the laws of the state of Oklahoma.
- j. SELLER'S "Terms and Conditions" as set forth above shall govern all transactions. Any inconsistent terms of BUYER wherever set forth and whether oral or written, shall not be binding upon SELLER unless agreed to by SELLER in writing. No waiver or exception to any of the hereinabove enumerated conditions or any of the special terms and provisions relating to any order shall be binding upon SELLER unless agreed to in writing by SELLER.
- k. SELLER reserves the right to change or discontinue the color, design, component content or price of any ITEMS in SELLER'S catalog or published price lists without prior notice at any time.

REV5/14

The specifications and prices listed in this document are subject to change. Carlisle does not assume responsibility for typographical errors.



4711 E Hefner Rd  
Oklahoma City, OK 73131  
Toll Free: 800.654.8210 • Toll Free Fax: 800.872.4701  
Phone: 405.475.5600 • [www.carlislefsp.com](http://www.carlislefsp.com)  
Printed in USA • CAT2015SMP  
©2015 Carlisle FoodService Products

