

VONDREHLE

An ESOP Company

PRODUCT CATALOG



Quality Towel & Tissue Products

- Since 1974 -

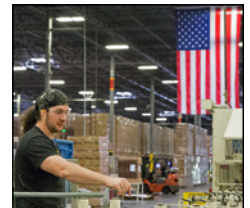
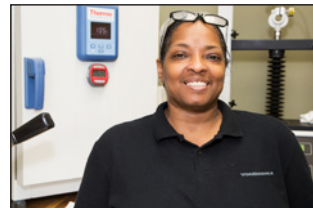
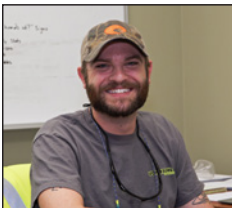

Employee-Owned • Made In The U.S.A.

T. 800-438-3631

INTEGRITY IS OUR
MOST IMPORTANT
ASSET.

www.vondrehle.com

About von Drehle Corporation

Facility Locations	1
Customer Support	2
Customer Resources	3
Environmental	6

Towel Systems

Centerpull Towel Systems	8
Mechanical Roll Towel Systems	12
Electronic Roll Towel Systems	16
10-Inch Roll Towel Systems	20
Folded Towel Systems	23

Tissue Systems

Bath Tissue Systems	31
Jumbo Roll Tissue Systems	36
Porta-Roll Tissue Systems	42

Household / Napkins / Wipers

Household Roll Towels	46
Facial Tissue	46
Napkins	47
Wipers	48

Installation / Adapters

Folded Towel Adapters	25
Recessed Cabinet Adapters	27
ADA Guidelines	30

Product Fitment Guide

Towel Products	28
Tissue Products	29
Index by Item Number	49

VONDREHLE

612 Third Avenue NE • Hickory, NC 28601
 Toll Free: 800-438-3631 • Fax: 828-322-4145
sales@vondrehle.com



von Drehle Headquarters

Hickory, North Carolina 28601

Tel: 800-438-3631 • www.vondrehle.com

Since 1974, customers have trusted von Drehle to provide quality products for the away-from-home market and to back those products with the best service in the industry. We welcome your questions and comments and look forward to helping you find solutions to all of your towel and tissue needs.

Blue Ridge Molding -

The von Drehle Corporation created Blue Ridge Molding - a plastic injection molding company to manufacture many of our dispensing systems. Using state-of-the-art, automated, electric injection equipment, allows us to provide you with superior quality dispensers at the lowest possible cost.



Production Facilities

With Production / Distribution facilities in your region and our nationwide experienced Sales & Support staff, we're close by when you need us.



Cordova, North Carolina
Paper Mill



Natchez, Mississippi
Paper Mill / Converting



Conover, North Carolina
Dispenser Manufacturing



Maiden, North Carolina
Converting



Memphis, Tennessee
Converting



Las Vegas, Nevada
Converting



Customer Service

von Drehle provides the finest customer service in the industry. When you call von Drehle, you never have to "Press 1" to talk to a live person. Instead, you always get to speak with a courteous, experienced professional who is there to help you.

Sales Support

von Drehle's nationwide, dedicated Sales Team Members are some of the most experienced and knowledgeable in the industry and can assist you with:

- Solution selling
- Conversions and estimations
- Joint sales calls & ride alongs
- National installation network
- Environmental impact training



Product Support

From informative videos to DSR Training Seminars to knowledgeable in-house Product Specialists, von Drehle provides complete support for every product and application.

- System Training Videos
- Installation & ADA Guidelines Information
- Specification Sheets & Sales Literature
- DSR Training Seminars
- Cost-in-Use Calculators



Limited Distribution

Are you running the Race-to-Zero? Are you selling the exact same products that all of your competitors offer - making it nothing but a pricing game? End the race with **von Drehle's Limited Distribution** business model. Provide your customers with unique, proven, value-oriented solutions that will save them time, labor, and money.



Proprietary Programs

von Drehle has a variety of controlled-use towel and tissue systems - keeping you in the door longer as a single-source supplier. von Drehle offers the simplest proprietary program in the industry:

- No end-user contracts or agreements
- No rebates to file or administer
- You own the dispensers after minimums

Ask your von Drehle Regional Sales Manager for complete details.



DSR Training

von Drehle offers one of the finest DSR Training Seminars in the industry. Featuring guest speakers and experienced, knowledgeable experts, these entertaining two-day seminars teach DSRs how to increase their sales, increase their margins and overcome objections. Ask your von Drehle Regional Sales Manager how you can attend.

- Sell more effectively and more efficiently
- Reduce the importance of pricing
- Increase your product knowledge
- Tour a working facility



Online Resources

Are you looking for a spec sheet, or perhaps a high-resolution product image? How about a high quality feature video or a short video on how to load a certain dispenser or use its stub-roll feature?

von Drehle's new website has everything you need in one convenient place.

Just go to www.vondrehle.com to view and/or download whatever you need:

- Product Comparisons
- Product Information
- Spec Sheets / Sales Sheets
- High-Resolution Product Images
- Feature Systems Videos
- Loading & Installation Videos
- ADA Guidelines Video
- Environmental Information
- And much more



Item #	Description	Feet Per Roll
6602T	PRESERVE 8.3 X 15 WHT 2PLY CPT	660
CP600	PRESERVE 7.6 X 15 WHT 2PLY CPT	
CP550T	ELEGANCE 7.6 X 15 WHT TAD CPT	
1077T	PRESERVE 7.6 X 14 WHT 1PLY CPT	
8888K	PRESERVE 7.9 X 15 BWN 1PLY CPT	
9901T	PRESERVE 8.3 X 15 WHT 1PLY CPT	
7501W	PRESERVE 7.9 X 15 WHT 1PLY CPT	
65076	PRESERVE 7.6 X 15 WHT 2PLY CPT	
5752T	PRESERVE 7.6 X 15 WHT 2PLY CPT	
400AL+	PRESERVE PLUS DRC 7.6 X 15 CPT	

Informative Videos

von Drehle's videos are an excellent resource - whether you simply need to learn how to load a dispenser or share with your customer or prospect the features and benefits of a certain towel or tissue system.

Download at: www.vondrehle.com

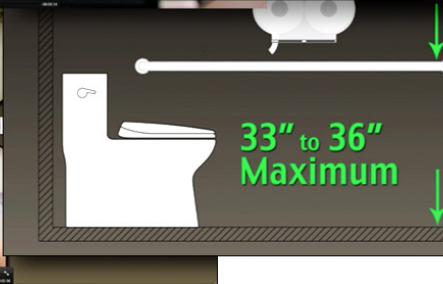
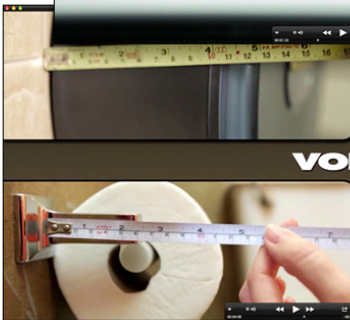
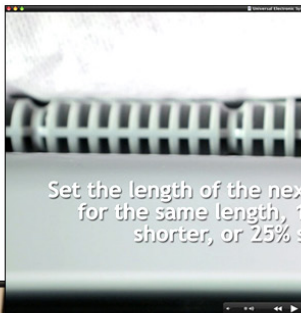

These Feature Videos are high-quality, informative, entertaining, and designed for both the DSR and End-User audiences. Download at: www.vondrehle.com

Feature Videos:

- Centerpull Towel Systems
- Mechanical Roll Towel
- Electronic Roll Towel
- 10-Inch Roll Towel
- Proprietary Roll Towel
- Jumbo Roll Tissue
- Porta-Roll Tissue
- Indestructible Dispensers
- ADA Guidelines
- About von Drehle
- von Drehle Manufacturing
- And many more

Since 1974, the von Drehle Corporation has been practicing environmentally sound production methods and has continued to ensure that the majority of our products are 100% recycled and meet or exceed EPA guidelines for post consumer content.

Having modern, efficient facilities and equipment allow von Drehle to produce high quality paper products consistently - and most importantly - responsibly.



The von Drehle Corporation has received Green Seal™ Certification for a variety of towel and tissue products



The von Drehle Corporation is an approved supplier on the EPA's Comprehensive Procurement Guidelines Supplier database



The von Drehle Corporation is a proud member and supporter of the U.S. Green Building Council



The von Drehle Corporation is an Approved Vendor and Ally Member of the Green Hotels Association

“ ” Quoted by...



“von Drehle’s modern converting facilities are other shining examples of total commitment.” - *Maintenance Sales News Magazine*

“The von Drehle paper mill is a perfect example of what can happen when a company commits itself to provide high quality products consistently - and most importantly -responsibly.” - *Maintenance Sales News Magazine*

Our Environmental Statement is just a very small part of the story. Discover how von Drehle’s innovative and proven methods lead the industry in total environmental responsibility and conservation...



von Drehle’s Paper Mills -
Cordova, NC, Natchez, MS

Our paper mills produce “parent rolls” to be used in our converting facilities. These paper mills house three paper machines that produce quality towel and tissue parent rolls made from 100% recycled fiber.

Each and every parent roll that is produced at our paper mills is made from 100% recycled paper fiber. **Not a single tree is harvested to supply our mills.** This recycled paper fiber contains a minimum of 50% post consumer content – diverting thousands of tons of waste paper from the landfill each year.

von Drehle’s state-of-the-art de-inking and cleaning facilities allow us to run a wider variety of waste paper – up to 100% post consumer waste – further reducing the amount of waste paper destined to end up in landfills. These facilities are able to use over 50% less water than the industry average - resulting in an annual savings of nearly 400,000,000 gallons of water.

von Drehle’s paper products are manufactured with a chlorine-free process and do not use solvents containing chlorine, benzene, cadmium and cadmium compounds, carbon tetrachloride, chloroform, chromium and chromium compounds, dichloromethane, lead and lead compounds, mercury and mercury compounds, methylethylketone, nickel and nickel compounds, tetrachloroethylene, toluene, 1-trichloroecane, trichloroethylene, or xylene.



von Drehle’s Converting Facilities -
Maiden, NC, Memphis, TN, Las Vegas, NV, Natchez, MS

Our 100% recycled parent rolls are received at our converting facilities and converted into quality towel and tissue products – all of which are, of course, made from 100% recycled paper fibers. These facilities are as large as 210,000 square feet, equipped with state-of-the-art machinery and qualified, dedicated, experienced technicians to ensure the quality of our products.

All of our end cuts or “cookies” are collected and recycled. von Drehle tracks the waste percentage in each facility and we are consistently below industry averages. Parent roll cores are collected and returned to the mill to be used again. von Drehle uses recycled pallets and sends any damaged pallets to be repaired and reused.

Local waste disposal companies were contacted and given samples of materials that were still being sent to the landfill. It was determined that the majority of these materials could also be recycled. Balers were installed to compact the recycled materials. By recycling, we were able to turn an expense into a profit center, and, at the same time, create a significant positive impact on the environment. Plastics, metals, and other scrap or waste items are now recycled instead of discarded.

Recycled Fiber - vs. - Virgin Fiber

By producing paper products made from 100% recycled paper fiber instead of from virgin fiber made from trees, von Drehle saves the following each year:

♻️ *Over 830,000 kw/h of Energy Consumption*

♻️ *Over 58,000,000 pounds of Greenhouse Gas (CO2)*

♻️ *Over 870,000,000 gallons of Water**

♻️ *Over 1,300,000 Trees*

Everyone Benefits

We’ve learned that reducing waste is not merely good stewardship of our environment – it makes good business sense. We not only have a significant positive impact on the environment and our natural resources, but we are able to lower our manufacturing costs. This enables us to lower our costs to our valued customers. In the end, everyone benefits.

The Simplest, Most Cost-Effective,
Hands-Free System Available...

One Towel at a Time.



Centerpull Towel Systems

No moving parts. No batteries to replace.
Just one clean, dry, germ-free towel at a time!



- Water** Resistant
- Flame** Resistant
- Impact** Resistant
- Vandalism** Resistant

Patented Dispensing Cone

For "One Towel At A Time" dispensing

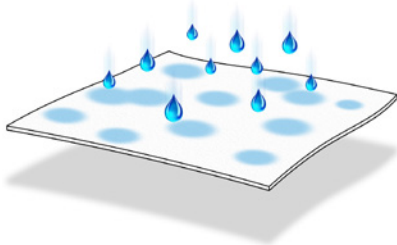

Highly Absorbent Toweling

Soft Towel Technology to reduce usage per hand-dry

High Capacity - Up to 1,000 Feet

To reduce maintenance demands



Hands-Free

Hygienic - Touch only the towel you use



Removable Tray

Sanitary - For quick and easy cleaning



Locking Mounting Plate

For easy washdowns or dispenser removal

A Solution For Any Environment



High Capacity and Hands-Free

von Drehle Item #6622 / #80BBW / #6525M

- Hands-Free - touch only the towel you use
- Holds up to 1,000 feet of toweling to reduce maintenance
- No moving parts - no batteries to replace
- Virtually indestructible
- Water resistant - great for washdowns
- Removable backing plate for ease of installation
- ADA compliant

Mini Centerpull for Small Spaces

von Drehle Item #2644

- 28% smaller footprint for tight spaces
- Hands-Free - touch only the towel you use
- Holds up to 400 feet of toweling
- No moving parts - no batteries to replace
- Virtually indestructible
- Water resistant - great for washdowns
- Removable backing plate
- ADA compliant



Can even be mounted and used upside-down!

Centerpull Towel Dispensers

Item #	Description	Dimensions H" x W" x D"	Units per Case	Cases per Pallet
6622	Centerpull Towel Dispenser with #2 Cone	14.25 x 11 x 12	2	40
80BBW	Centerpull Towel Dispenser with #1 Cone	14.25 x 11 x 12	2	40
6525M	Centerpull Towel Dispenser with "M" Cone	14.25 x 11 x 12	2	40
2644	Mini Centerpull Towel Dispenser	14 x 8 x 7	2	60

Item #6622 uses the following products: 1077T, 8888K, 9901T, 7501W, 6602T, 65076, CP600, 5752T, CP550T

Item #80BBW uses the following products: 400AL+

Item #6525M uses the following products: 52W250

Item #2644 uses the following products: 4400, CP320, CP264, CP300T, CP352

Centerpull Towels

1-Ply, 2-Ply
Premium, Wipers
Mini Centerpull Towels



Preserve® 1-Ply Value Centerpull Towels

Item #	Description	Feet per Roll	Rolls per Case	Cases per Pallet	Feet per Case
<i>Use with dispenser #6622</i>					
1077T	1-Ply White Centerpull Towel	1,000	6	55	6,000
8888K	1-Ply Kraft Centerpull Towel	1,000	6	50	6,000
9901T	1-Ply White Centerpull Towel	990	6	50	5,940
7501W	1-Ply White Centerpull Towel	800	6	50	4,800

Preserve® 2-Ply Performance Centerpull Towels

Item #	Description	Feet per Roll	Rolls per Case	Cases per Pallet	Feet per Case
<i>Use with dispenser #6622</i>					
6602T	2-Ply White Centerpull Towel	660	6	50	3,960
65076	2-Ply White Centerpull Towel	650	6	55	3,900
CP600	2-Ply White Centerpull Towel	600	6	55	3,600
5752T	2-Ply White Centerpull Towel	575	6	55	3,450

Premium Centerpull Towels / Wipers

Item #	Description	Feet per Roll	Rolls per Case	Cases per Pallet	Feet per Case
400AL+	DRC White Centerpull Towel/Wiper ¹⁾	400	6	55	2,400
52W250	DRC Blue Centerpull Towel/Wiper ²⁾	250	6	50	1,500
CP550T	Premium TAD Centerpull Towel ³⁾	550	6	60	3,300
CP73	4-Ply Blue Centerpull Towel ⁴⁾	500	2	48	1,000

¹⁾ Use with #80BBW Dispenser ²⁾ Use with #6525M Dispenser ³⁾ Use with #6622 Dispenser ⁴⁾ No dispenser available

Mini Centerpull Towels

Item #	Description	Feet per Roll	Rolls per Case	Cases per Pallet	Feet per Case
<i>Use with dispenser #2644</i>					
4400	1-Ply White Mini Centerpull Towel	400	12	60	4,800
CP320	2-Ply White Mini Centerpull Towel	320	12	55	3,840
CP264	2-Ply White Mini Centerpull Towel	264	12	60	3,168
CP300T	Premium TAD Mini Centerpull Towel	300	12	60	3,600
CP352	2-Ply White Mini Centerpull Napkin	300	24	45	7,200



= Green Seal™ Certified GS-1



= Made from 100% recycled fiber

The Versatile, Cost-Effective,
High Capacity, Solution...

**With No Batteries Required.
Ever!**



Mechanical Roll Towel Systems

Hands-Free with No Batteries Required.

High Capacity and Hands-Free

von Drehle Item #8864 / #8864W / #8897 / #8897W

- Touch only the towel you use
- Holds up to 800 feet of toweling to reduce maintenance
- Long paper tail and low pull force reduce tabbing
- Side knob to advance paper and make loading easy
- Advertising window for information or promotion
- Cuts an 11-inch towel to control usage
- Available for 2" cores or 1.625" cores
- Available in Smoke or White
- ADA compliant



available in white



Compact and Hands-Free

von Drehle Item #8838 / #8838W

- Touch only the towel you use
- 22% smaller footprint than full-size dispensers
- Reduced core size (1.625") to allow more footage
- Holds up to 600 feet of toweling
- Side knob to make loading easy
- Advertising window for information / promotion
- Cuts an 11-inch towel to control usage
- Available in Smoke or White
- ADA compliant



available in white



Hands-Free Mechanical Roll Towel Dispensers

Item #	Description	Dimensions H" x W" x D"	Units per Case	Cases per Pallet
8864	Smoke Hands-Free Dispenser (2" cores)	16 x 12 x 10.2	1	96
8864W	White Hands-Free Dispenser (2" cores)	16 x 12 x 10.2	1	96
8897	Smoke Hands-Free Dispenser (1.625" cores)	16 x 12 x 10.2	1	96
8897W	White Hands-Free Dispenser (1.625" cores)	16 x 12 x 10.2	1	96
8838	Smoke Hands-Free Compact Dispenser	12.3 x 12.3 x 7.6	1	160
8838W	White Hands-Free Compact Dispenser	12.3 x 12.3 x 7.6	1	160

Item #8864 / #8864W use the following products: 835B/N, 860B/N, 880B/N, 88012B/N, 88012T

Item #8897 / #8897W use the following products: 88115B/N, 863B/N, 88106-B/N, 828B/N

Item #8838 / #8838W uses the following products: 863B/N, 835B/N

Consistent, Reliable Dispensing

Mechanical



High Capacity Push Lever Dispenser

von Drehle Item #3467 / #3467-SP

- Holds up to 800 feet of toweling to reduce maintenance
- Locking mechanism reduces pilferage
- Simple and reliable dispensing every time
- Stub roll feature to reduce waste
- Each push dispenses 5.5-inches of toweling
- Available for 2" cores or 1.625" cores

Push Lever Roll Towel Dispenser

Item #	Description	Dimensions H" x W" x D"	Units per Case	Cases per Pallet
3467	8-Inch Push Lever Dispenser (2" cores)	15.5 x 10.5 x 10.2	1	63
3467SP	8-Inch Push Lever Dispenser (1.625" cores)	15.5 x 10.5 x 10.2	1	63

Item #3467 uses the following products: 835B/N, 860B/N, 880B/N, 88012B/N, 88012T

Item #3467SP uses the following products: 88115B/N, 863B/N

Average Use per Hand Dry:

Folded Towel Dispenser

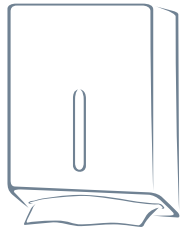

With 500 Towels

4.2
Towels
369
Square Inches
119
Hand Dries
per Refill

VONDREHLE Push Lever



With 800' Roll

29.1
Linear Inches
233
Square Inches
330
Hand Dries
per Refill

VONDREHLE Compact



With 600' Roll

2
Towels
154
Square Inches
327
Hand Dries
per Refill

VONDREHLE Pull-Down



With 800' Roll

2
Towels
154
Square Inches
436
Hand Dries
per Refill

8-Inch Hardwound Roll Towels

Preserve® Roll Towels - Available in **White** or **Natural**, these towels are an excellent choice for economical, everyday use.

Preserve® Heavy Weight Roll Towels - These towels boast an **Extra-Heavy Basis Weight** for increased **Strength, Bulk, and Absorbency**.

Elegance® Premium TAD Roll Towels - **Through-Air-Dried (TAD)** technology makes these premium towels **Softer, Stronger, and More Absorbent** - perfect for high-end markets.



Preserve® Hardwound Roll Towels

Item #	Description	Feet per Roll	Core Size	Rolls per Case	Cases per Pallet	Feet per Case
White - Made From 100% Recycled Fiber						
835-B	Preserve® White Roll Towel	350	2.0"	12	55	4,200
860-B	Preserve® White Roll Towel	600	2.0"	12	42	7,200
880-B	Preserve® White Roll Towel	800	2.0"	6	55	4,800
88012-B	Preserve® White Roll Towel	800	2.0"	12	35	9,600
863B	Preserve® White Roll Towel	600	1.625"	12	42	7,200
88106-B	Preserve® White Roll Towel	800	1.625"	6	55	4,800
88115-B	Preserve® White Roll Towel	800	1.625"	12	35	9,600
Natural - Made From 100% Recycled Fiber						
835-N	Preserve® Natural Roll Towel	350	2.0"	12	55	4,200
860-N	Preserve® Natural Roll Towel	600	2.0"	12	42	7,200
880-N	Preserve® Natural Roll Towel	800	2.0"	6	55	4,800
88012-N	Preserve® Natural Roll Towel	800	2.0"	12	35	9,600
863N	Preserve® Natural Roll Towel	600	1.625"	12	42	7,200
88106-N	Preserve® Natural Roll Towel	800	1.625"	6	55	4,800
88115-N	Preserve® Natural Roll Towel	800	1.625"	12	35	9,600

Preserve® Heavy Weight Hardwound Roll Towels

Item #	Description	Feet per Roll	Core Size	Rolls per Case	Cases per Pallet	Feet per Case
Made From 100% Recycled Fiber						
828B	Heavy Weight White Towel	600	1.625"	12	42	7,200
828N	Heavy Weight Natural Towel	600	1.625"	12	42	7,200

Elegance® Premium Hardwound Roll Towels

Item #	Description	Feet per Roll	Core Size	Rolls per Case	Cases per Pallet	Feet per Case
TAD - Through-Air-Dried Premium Toweling						
88012T	Elegance® Premium Roll Towel	800	2.0"	12	30	9,600
88115T	Elegance® Premium Roll Towel	800	1.625"	12	30	9,600



= Green Seal™ Certified GS-1



= Made from 100% recycled fiber

The Hygienic, Cost-Saving,
High Capacity, Solution.

Hands-Free Electronic Dispensing



Programmable Roll Towel Systems

Hands-Free Hygienic Dispensing.

Fully Programmable Electronic Dispenser

von Drehle Item #2245 / #2245W

- Touch only the towel you use
- "No Wave" sensor for increased sanitation
- Extra long battery life - up to 72,000 dispenses
- Low battery indicator for fewer surprises
- Holds up to 800 feet of toweling
- Available in Smoke or White
- Fully programmable to control usage costs
 - First sheet length: 9", 12", or 15"
 - Time delay: 1, 2, or 3 seconds
 - Additional sheet: 0%, 12.5%, or 25% shorter
- ADA compliant



available in white



Electronic

Hands-Free Electronic Dispenser

von Drehle Item #8080E

- Touch only the towel you use
- Side knob as a mechanical back-up feature
- Holds up to 800 feet of toweling to reduce maintenance
- Textured cover resists fingerprints and smudges
- Programmable to control usage costs
 - "Hidden" or "Exposed" mode
 - Sheet Length: 8", 12", or 16"
 - Time delay: 0, 1, or 3 seconds
- ADA compliant



Hands-Free Electronic Roll Towel Dispensers

Item #	Description	Dimensions H" x W" x D"	Units per Case	Cases per Pallet
2245	Smoke Programmable Electronic Dispenser	15.25 x 12.25 x 9.5	1	63
2245W	White Programmable Electronic Dispenser	15.25 x 12.25 x 9.5	1	63
8080E	Hands-Free Electronic Dispenser	15.75 x 12.25 x 9.25	1	36

Item #2245 / #2245W use the following products: 835B/N, 860B/N, 880B/N, 88012B/N, 88012T

Item #8080E uses the following products: 835B/N, 860B/N, 880B/N, 88012B/N, 88012T

#2245 / #2245W

#8080E

**Electronic Dispenser
Side-by-Side
Feature Comparison**



Hygienic Hands-Free Dispensing	✓	✓
Programmable First Sheet Length	✓	✓
Programmable Second Sheet Length	✓	
Programmable Time Delay	✓	✓
"Hidden" Paper Mode	✓	✓
"Exposed" Paper Mode		✓
Extra Long Battery Life	✓	
External Low Battery Indicator	✓	
Internal Low Battery Indicator		✓
Side Paper Advance Knob		✓
"No Wave" Sensor	✓	
Textured Cover	✓	✓
High Capacity	✓	✓
ADA Compliant	✓	✓
Available in White	✓	

Average Use per Hand Dry:

Folded Towel Dispenser

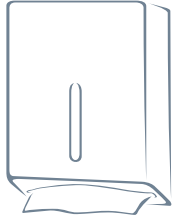

With 500 Towels

4.2

Towels

369

Square Inches

119

Hand Dries per Refill

Push Lever Dispenser

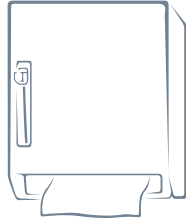

With 800' Roll

29.1

Linear Inches

233

Square Inches

330

Hand Dries per Refill

Standard Dispenser

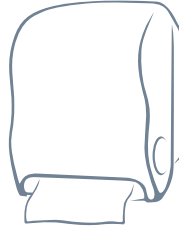

2

Towels

176

Square Inches

436

Hand Dries per Refill

VONDREHLE #2245



With 800' Roll

2

Towels

110 to 210

Square Inches

610 to 320

Hand Dries per Refill

VONDREHLE #8080E



With 800' Roll

2

Towels

128 to 256

Square Inches

600 to 300

Hand Dries per Refill

Electronic

8-Inch Hardwound Roll Towels

Preserve® Roll Towels - Available in **White** or **Natural**, these towels are an excellent choice for economical, everyday use.

Elegance® Premium TAD Roll Towels - Through-Air-Dried (TAD) technology makes these premium towels **Softer**, **Stronger**, and **More Absorbent** - perfect for high-end markets.



Preserve® Hardwound Roll Towels

Item #	Description	Feet per Roll	Core Size	Rolls per Case	Cases per Pallet	Feet per Case
White - Made From 100% Recycled Fiber						
835-B	Preserve® White Roll Towel	350	2.0"	12	55	4,200
860-B	Preserve® White Roll Towel	600	2.0"	12	42	7,200
880-B	Preserve® White Roll Towel	800	2.0"	6	55	4,800
88012-B	Preserve® White Roll Towel	800	2.0"	12	35	9,600
Natural - Made From 100% Recycled Fiber						
835-N	Preserve® Natural Roll Towel	350	2.0"	12	55	4,200
860-N	Preserve® Natural Roll Towel	600	2.0"	12	42	7,200
880-N	Preserve® Natural Roll Towel	800	2.0"	6	55	4,800
88012-N	Preserve® Natural Roll Towel	800	2.0"	12	35	9,600

Elegance® Premium Hardwound Roll Towels

Item #	Description	Feet per Roll	Core Size	Rolls per Case	Cases per Pallet	Feet per Case
TAD - Through-Air-Dried Premium Toweling						
88012T	Elegance® Premium Roll Towel	800	2.0"	12	30	9,600



= Green Seal™ Certified GS-1



= Made from 100% recycled fiber

The One Towel, High Capacity,
Cost-Effective Solution.

Mechanical - and - Electronic

10-Inch



10 Inches Wide!



10 Inches Wide!

10-Inch Roll Towel Systems

“One Towel Can Equal One Hand-Dry”

10-Inch Electronic Dispenser

von Drehle Item #1080E

- Touch only the towel you use
- Side knob as a mechanical back-up feature
- Holds up to 800 feet of toweling to reduce maintenance
- Programmable to control usage costs
 - “Hidden” or “Exposed” mode
 - Sheet Length: 8”, 12”, or 16”
 - Time delay: 0, 1, or 3 seconds
- ADA compliant



10-Inch

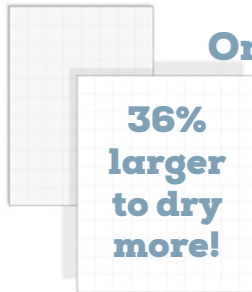

One Towel = One Hand-Dry

- 120 Square Inches** - vs. average of 88 sq. inches
- Strong & Absorbent** - to reduce usage
- Reduces Maintenance** - up to 800 hand-dries per refill

10-Inch Mechanical Dispenser

von Drehle Item #1061

- Touch only the towel you use
- No batteries to replace - ever!
- Holds up to 800 feet of toweling to reduce maintenance
- Side knob to advance paper and make loading easy
- Cuts a 12-inch towel to control usage
- ADA compliant



Hands-Free 10-Inch Roll Towel Dispensers

Item #	Description	Dimensions H" x W" x D"	Units per Case	Cases per Pallet
1080E	10-Inch Programmable Electronic Dispenser	16.5 x 14.5 x 9.5	1	64
1061	10-Inch Mechanical Pull-Down Dispenser	16.5 x 14.5 x 9.5	1	64

Items #1080E and #1061 use the following products: 816B/N, 810B/N, 816T

Average Use per Hand Dry:

Folded Towel Dispenser

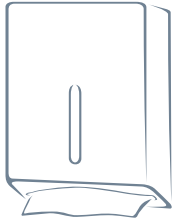

With 500 Towels

4.2
Towels

369
Square Inches

119
Hand Dries
per Refill

Push Lever Dispenser

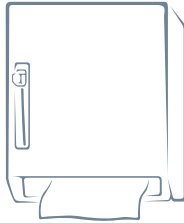

With 800' Roll

29.1
Linear Inches

233
Square Inches

330
Hand Dries
per Refill

Standard Dispenser

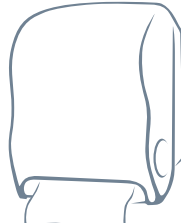

With 800' Roll

2
Towels

176
Square Inches

436
Hand Dries
per Refill

VONDREHLE #1061



With 800' Roll

1
Towel

120
Square Inches

800
Hand Dries
per Refill

VONDREHLE #1080E



With 800' Roll

1
Towel

80 to 160
Square Inches

1200 to 600
Hand Dries
per Refill

10-Inch Hardwound Roll Towels

Preserve® Roll Towels - Available in **White** or **Natural**, these towels are an excellent choice for economical, everyday use.

Preserve® Heavy Weight Roll Towels - These towels boast an **Extra-Heavy Basis Weight** for increased **Strength, Bulk, and Absorbency**.

Elegance® Premium TAD Roll Towels - Through-Air-Dried (TAD) technology makes these premium towels **Softer, Stronger, and More Absorbent** - perfect for high-end markets.



Preserve® 10-Inch Hardwound Roll Towels

Item #	Description	Feet per Roll	Core Size	Rolls per Case	Cases per Pallet	Feet per Case
Made From 100% Recycled Fiber						
816B	10" Preserve® White Roll Towel	800	1.75"	6	45	4,800
816N	10" Preserve® Natural Roll Towel	800	1.75"	6	45	4,800
Heavy Weight Roll Towels Made From 100% Recycled Fiber						
810B	10" Preserve® White Roll Towel	600	1.75"	6	45	3,600
810N	10" Preserve® Natural Roll Towel	600	1.75"	6	45	3,600

Elegance® Premium 10-Inch Hardwound Roll Towels

Item #	Description	Feet per Roll	Core Size	Rolls per Case	Cases per Pallet	Feet per Case
TAD - Through-Air-Dried Premium Towing						
816T	10" Elegance® Premium Roll Towel	800	1.75"	6	45	4,800

= Green Seal™ Certified GS-1

= Made from 100% recycled fiber

10-Inch

The Versatile, Hands-Free,
Folded Towel Solution.



Folded Towel Systems



Smoke Folded Towel Dispenser

von Drehle Item #175AO 

- Hands-free dispensing
- Locking feature
- Translucent cover
- Holds 500 multifolds
- Holds 300 C-folds

White Folded Towel Dispenser

von Drehle Item #185AOW 

- Hands-free dispensing
- Locking feature
- Translucent viewing window
- Holds 750 multifolds
- Holds 450 C-folds
- Holds 750 single-folds

Hands-Free Folded Towel Dispensers

Item #	Description	Dimensions H" x W" x D"	Units per Case	Cases per Pallet
175AO	Smoke/Black Folded Towel Dispenser	15.2 x 11.2 x 5.0	6	25
185AOW	White Folded Towel Dispenser	16.8 x 12.4 x 4.8	1	210

Item #175AO uses the following products: 548-W/K/T, 524-W/T

Item #185AOW uses the following products: 548-W/K/T, 524-W/T, 540-W/K

Folded Towels

Preserve® Folded Towels - Available in **White** or **Natural**, these towels are made from 100% recycled fiber and are an excellent choice for economical, everyday use.



Elegance® Premium TAD Roll Towels - Through-Air-Dried (TAD) technology makes these premium towels **Softer, Stronger, and More Absorbent** - perfect for high-end markets.



Cost Saving Solutions



Compact Mini Fold System

von Drehle Item #154AO 

The 6-inch by 9.5-inch Mini Folds are perfect for use in patient rooms, classrooms, cafeterias, as door handle wipers, or wherever a full-size towel is not needed. And, they dispense one at a time - instead of by the handful. Holds 250 Mini Folds.

Vertical or Horizontal Mini Fold System

von Drehle Item #265AO 

Spring-loaded to allow mounting vertically or setting horizontally on a countertop for use as an economical napkin dispenser. Holds 500 Mini Folds.



Cost-Saving Adapters

von Drehle Item #545-ADP 

von Drehle Item #0036660 

Manufactured from stamped steel, these ingenious adapters will reduce costs for years.

- **Black Mini Fold Adapter:** Convert folded towel dispensers to dispense von Drehle's Mini Folds one at a time.
- **White "One At A Time" Adapter:** Dispense full-size towels on at a time - instead of by the handful.



Folded Towels

Mini Fold Dispensers & Adapters

Item #	Description	Dimensions H" x W" x D"	Units per Case	Cases per Pallet
154AO	Compact Mini Fold Dispenser	7.7 x 7.1 x 4.1	4	60
265AO	Vertical/Horizontal Mini Fold Dispenser	5.8 x 8.0 x 15.7	6	25
545-ADP	Mini Fold Adapter	10.5 x 10.75 x 3	1	-
0036660	"One At A Time" Adapter	1.5 x 10.75 x 3	12	-
545-CVR	154AO Retrofit Cover	15 x 11 x .0625	1	-

Items #154AO, #265AO, and #545-ADP use the following products: 545-W/K/T

Item #0036660 use the following products: 548-W/K/T



Item #545-CVR covers old, unused mounting holes - black, textured plastic

Mini Folds

Available in **White**, **Natural**, or **Premium TAD**, these 6-inch by 9.5-inch Mini Folds are slightly smaller than multifold towels (35%), but can offer huge savings over full size towels.





Preserve® Multifold Towels - Made From 100% Recycled Fiber

Item #	Description	Sheet Size	Towels per Pack	Towels per Case	Cases per Pallet
 548-W	Preserve® White Multifold	9.25" x 9.5"	250	4,000	63
 548-K	Preserve® Natural Multifold	9.25" x 9.5"	250	4,000	63

Elegance® Premium Multifold Towels - Premium TAD

Item #	Description	Sheet Size	Towels per Pack	Towels per Case	Cases per Pallet
548T	Elegance® White TAD Multifold	9.25" x 9.5"	175	2,800	63

Preserve® Single-Fold Towels - Made From 100% Recycled Fiber

Item #	Description	Sheet Size	Towels per Pack	Towels per Case	Cases per Pallet
 540-W	Preserve® White Single Fold	9.25" x 10.25"	250	4,000	60
 540-K	Preserve® Natural Single Fold	9.25" x 10.25"	250	4,000	60



Preserve® C-Fold Towels - Made From 100% Recycled Fiber

Item #	Description	Sheet Size	Towels per Pack	Towels per Case	Cases per Pallet
 524-W	Preserve® White C-Fold	9.0" x 13.0"	200	2,400	72

Elegance® C-Fold Towels - Premium TAD

Item #	Description	Sheet Size	Towels per Pack	Towels per Case	Cases per Pallet
 524T	Elegance® White TAD C-Fold	9.0" x 13.0"	175	2,100	72

Preserve® Mini Folds - Made From 100% Recycled Fiber

Item #	Description	Sheet Size	Towels per Pack	Towels per Case	Cases per Pallet
 545-W	Preserve® White Mini Fold	6.0" x 9.5"	250	8,000	49
 545-K	Preserve® Natural Mini Fold	6.0" x 9.5"	250	8,000	49

Elegance® Premium Mini Folds - Premium TAD

Item #	Description	Sheet Size	Towels per Pack	Towels per Case	Cases per Pallet
545-T	Elegance® White TAD Mini Fold	6.0" x 9.5"	175	5,600	49



Multifold Towels



Single-Fold Towels



C-Fold Towels



Premium TAD



Mini Folds



= Green Seal™ Certified GS-1



= Made from 100% recycled fiber

Folded Towels

Recessed Towel Cabinet Adapters

The perfect solution to convert recessed folded-towel cabinets into economical Roll Towel Systems. These two-piece adapter sets provide a sturdy mount and a finished look. The outer cover fits snugly around our roll towel dispensers (#8080E or #8864), and the back mounting plates allow easy access to the key locks and manual feed knobs.

Simple Installation:

- Remove recessed cabinet door
- Attach outer cover using mounting tape
- Attach back plate to cabinet
- Attach dispenser to mounting plate
- Load dispenser and close

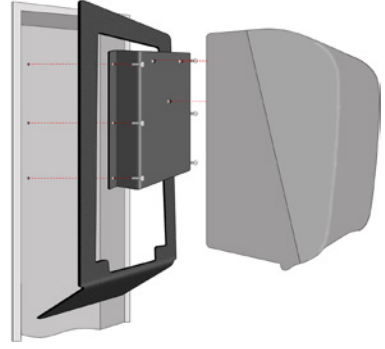

Item #	Description	Dimensions H" x W" x D"	Units per Case
SHRD-CTR	Shroud for 8080E Dispenser	22.5 x 16.5 x 2.5	5
SHRD-MP	Back Mounting Plate - 8080E	11 x 11.25 x 1.75	5
SHRD-CTR-8864	Shroud for 8864 Dispenser	22.5 x 16.5 x 2.5	5
SHRD-MP-8864	Back Mounting Plate - 8864	11 x 11.25 x 1.75	5

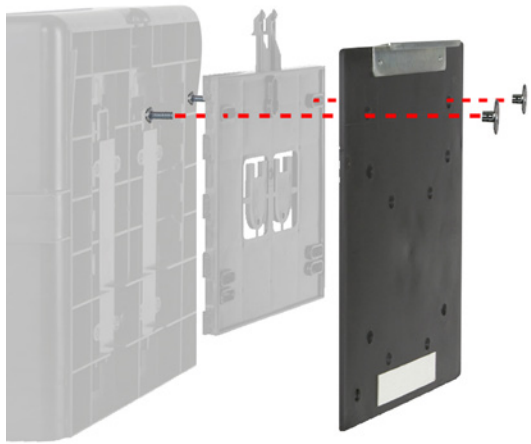

Recessed Towel Cabinet Adapter Bracket von Drehle Item #MPSSR

These adapter brackets are a simple and economical solution used to convert recessed folded-towel cabinets into Centerpull or Hardwound Towel dispensers. Simply hang the adapter on the cabinet door, close the door, and you are done!

- Takes just minutes to install
- Requires no drilling into cabinet
- Installation hardware is included



Item #	Description	Dimensions H" x W" x D"	Units per Case
MPSSR	Recessed Towel Cabinet Adapter Bracket	14 x 13.75 x 5.25	16

Adapters



#6622
 1077T
 8888K
 9901T
 7501W
 6602T
 65076
 CP600
 5752T
 CP550T



#80BBW
 400AL+



#6525M
 52W250



#2644
 4400
 CP320
 CP264
 CP300T
 CP352



**#8864, #8864W, #3467,
 #2245, #2245W, #8080E**

835B white, 835N natural
 860B white, 860N natural
 880B white, 880N natural
 88012B white, 88012N natural
 88012T premium TAD

(8" wide - 2" core)

von Drehle offers a complete line of **Controlled-Use** proprietary dispensing systems. Contact your von Drehle Regional Sales Manager for complete details.



**#8838, #8838W,
 #3467SP, #8897,
 #8897W**

863B white
 863N natural
 88115B white
 88115N natural

(8" wide - 1 1/2" core)



**#1061
 #1080E**

816B white
 816N natural
 810B white
 810N natural
 816T TAD

(10" wide - 1 1/2" core)



**#175AO
 #185AOW**

548W white
 548K natural
 548T TAD
 524W white
 524T TAD



**#154AO
 #265AO**

545W white
 545K natural
 545T TAD



#25000
1001, 5501,
RR123, 65048,
6022, 5022,
24480,
3302, 4521,
4537, RT500,
RR600, 65098,
9455, 8215



#CT405
1001
5501
RR123
6022
5022
24480
3302
4521
4537
RT500
RR600
9455
8215



#AE42V
(for 3.3" cores)
PQ800
1208-8
1209
120VT
2109



#AE42N
(for 2.3" cores)
2750
1125
1450
1500



#3253
(for 3.3" cores)
PQ800
1208-8
1209
120VT
2109



#3662
(for 3.3" cores)
2750
1125
1450
1500



#31002A
2212
4112



#3275
(Mini Twin)
2750
1500



#3200
(Porta-Roll)
PR350
PR420
PR420VT
PR470
PR750
PR940



#3342
(Porta-Roll)
PR350
PR420
PR420VT
PR750



Do you need a dispenser that can handle a 7,300 lb. truck?
Innovative. Indestructible. Stylish. Cost-Effective.

von Drehle offers a complete line of **Controlled-Use** proprietary dispensing systems.

Contact your von Drehle Regional Manager for complete details.

Fitment Guide

Americans with Disabilities Act (ADA)

To comply with current ADA regulations, install von Drehle ADA compliant dispensers according to the guidelines shown below. Complete ADA regulations are available for download at www.ada.gov

For questions or concerns, contact the ADA toll free at 800-514-0301

ADA Guidelines

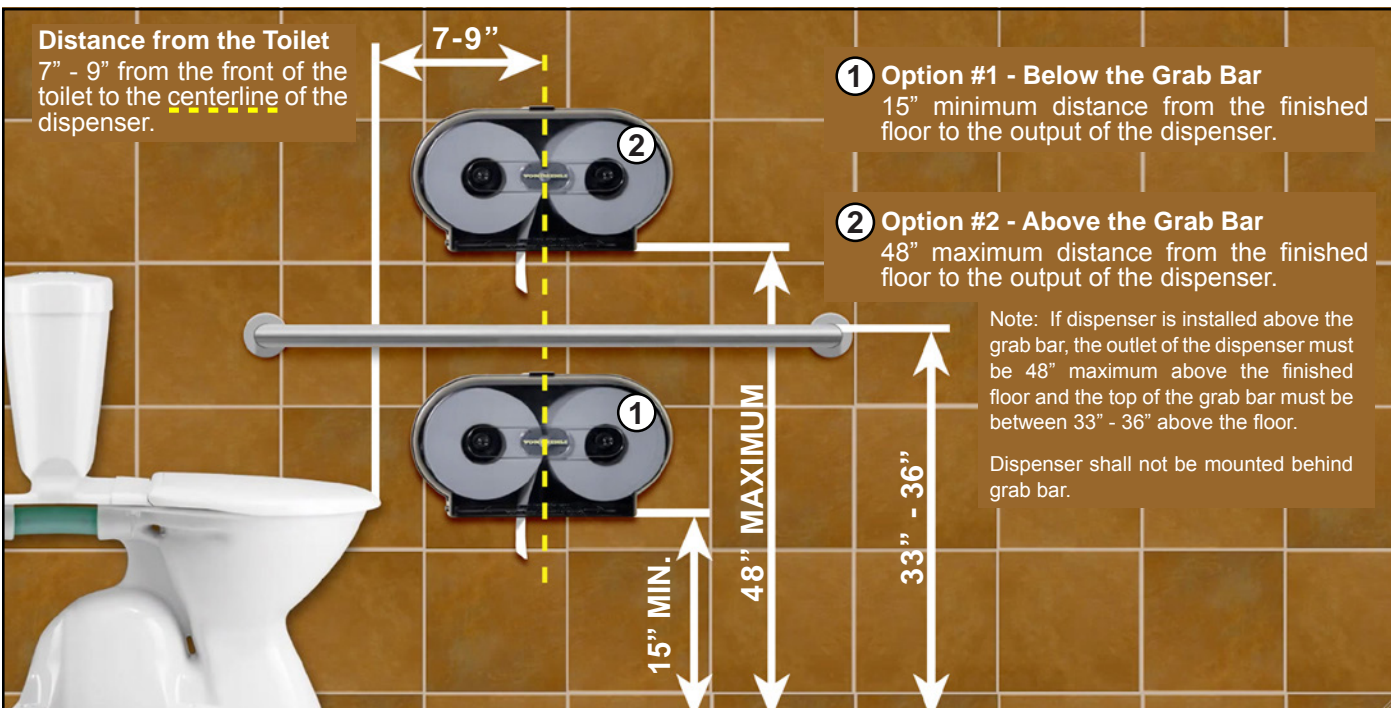
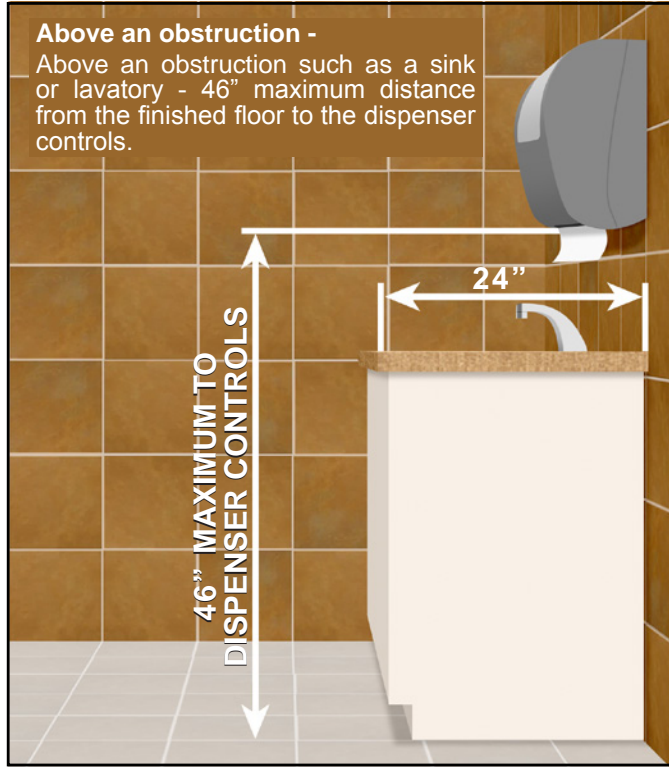

The Cost-Effective, Sanitary, Versatile,
Bath Tissue Solution.



Standard Bath Tissue Systems

- ✓ Fully Enclosed = **Reduce waste**
- ✓ Locking Features = **Reduce pilferage**
- ✓ More Uses per Refill = **Reduce labor costs**

More Footage per Roll

Reduces maintenance demands and the chance of run-outs over the leading consumer bath tissue as well as most away-from-home tissues



Stub Roll Features

Eliminates stub roll waste and reduces the chance of run-outs



Enclosed & Lockable

Reduces waste by protecting tissue from damage and eliminates pilferage



Average Uses per Refill:

Average
Leading Consumer
2-Ply Tissue

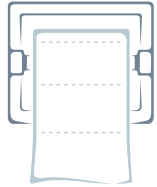

2-Ply
4" sheet length
290 sheets

96 Feet
of 2-ply tissue

29 Uses
per roll

VONDREHLE
4.5" x 3.6"
2-Ply Tissue



von Drehle
2-Ply
500 sheets

150 Feet
of 2-ply tissue

46 Uses
per roll

VONDREHLE
4.5" x 4.5"
2-Ply Tissue



von Drehle
2-Ply
500 sheets

187.5 Feet
of 2-ply tissue

57 Uses
per roll

VONDREHLE
#25000
2-Roll Dispenser



2-Ply
4.5" x 4.5"
500 sheets

375 Feet
of 2-ply tissue

115 Uses
per refill

VONDREHLE
#CT405
4-Roll Dispenser



2-Ply
4.5" x 4.5"
500 sheets

750 Feet
of 2-ply tissue

231 Uses
per refill

Variety & Versatility

Bath Tissue

2-Ply Tissue - Soft & Absorbent

Available in **Various Lengths, Widths, Sheet Counts, and Case Counts**, these soft and absorbent tissues are made from 100% recycled fiber.

1-Ply Tissue - Most Footage per Roll

Available in **Various Lengths**, these tissues provide the most footage per roll and are made from 100% recycled fiber.

Premium Virgin 2-Ply Tissue

Made from 100% **Virgin Fiber**, these tissues are **Softer** and **Brighter** - perfect for high-end markets.



Cost-Effective, Hygienic Dispensing.

Twin Roll Bath Tissue Dispenser

von Drehle Item #25000

- Locking mechanism to reduce theft
- Back-up roll to prevent run-outs
- Translucent cover to monitor tissue supply
- Metal back plate for durability
- Holds two rolls of standard bath tissue
- Small footprint for limited space areas
- ADA compliant



4-Roll Carousel Bath Tissue Dispenser

von Drehle Item #CT405

- Locking mechanism to reduce theft
- Back-up rolls to prevent run-outs
- Translucent cover to monitor tissue supply
- Stub roll feature to reduce waste
- Holds four rolls of standard bath tissue
- Easy-turn knob to advance rolls
- ADA compliant



Standard Bath Tissue Dispensers





Item #	Description	Dimensions H" x W" x D"	Units per Case	Cases per Pallet
25000	Twin Roll Bath Tissue Dispenser	13 x 6 x 6	6	42
CT405	4-Roll Carousel Bath Tissue Dispenser	14.9 x 13.1 x 6.1	1	144

Items #25000 and #CT405 use all von Drehle standard bath tissue

1-Ply Embossed Standard Bath Tissue

Item #	Description	Sheet Size	Sheets per Roll	Rolls per Case	Cases per Pallet	Feet per Case
--------	-------------	------------	-----------------	----------------	------------------	---------------

Made from 100% Recycled Fiber

 1001	Blue Mist® Bath Tissue	4.5" x 4.5"	1,000	96	25	36,000
 5501	Blue Mist® Bath Tissue	4.5" x 3.6"	1,000	96	25	28,800
 RR123	Roto-Roll® Bath Tissue	3.87" x 4.0"	1,232	48	42	19,712
 65048	Preserve® Bath Tissue ¹⁾	3.87" x 15"	520	48	30	31,200

¹⁾ For use with dispenser #25000 only.









#25000



2-Ply Embossed Standard Bath Tissue

Item #	Description	Sheet Size	Sheets per Roll	Rolls per Case	Cases per Pallet	Feet per Case
--------	-------------	------------	-----------------	----------------	------------------	---------------

Made from 100% Recycled Fiber

 6022	Feather Soft® Bath Tissue	4.5" x 4.5"	500	96	25	18,000
 5022	Feather Soft® Bath Tissue	4.5" x 3.6"	500	96	25	14,400
 3302	Feather Soft® Bath Tissue	4.5" x 3.6"	330	96	25	9,504
 24480	Feather Soft® Bath Tissue	4.0" x 4.0"	550	80	25	14,666
 4521	Feather Soft® Bath Tissue	4.5" x 3.6"	500	48	50	7,200
 4537	Feather Soft® Bath Tissue	4.5" x 3.6"	370	48	50	5,328
 RT500	Premium Quality® Bath Tissue	4.3" x 3.6"	500	96	25	14,400
 RR600	Roto-Roll® Bath Tissue	3.87" x 4.0"	616	48	42	9,856
 65098	Preserve® Bath Tissue ¹⁾	3.87" x 15"	260	48	30	15,600

¹⁾ For use with dispenser #25000 only.

#CT405



2-Ply Premium Virgin Standard Bath Tissue

Item #	Description	Sheet Size	Sheets per Roll	Rolls per Case	Cases per Pallet	Feet per Case
--------	-------------	------------	-----------------	----------------	------------------	---------------

Made from 100% Virgin Fiber

9455	Precious® Virgin Bath Tissue	4.5" x 4.5"	500	96	25	18,000
8215	Precious® Virgin Bath Tissue	4.5" x 3.6"	500	96	25	14,400



Feather Soft®



Premium Quality®



Precious®



Blue Mist®



Roto-Roll®



Preserve®

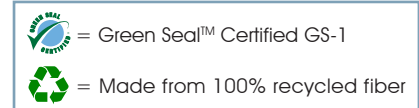

The High Capacity, Cost-Effective, Sanitary,
Tissue Solution.



Jumbo Roll Tissue Systems

Jumbo Tissue

- ✓ Fully Enclosed = **Reduce waste**
- ✓ Locking Features = **Reduce pilferage**
- ✓ More Footage per Roll = **Reduce labor costs**



More Footage per Roll

Reduces maintenance demands by up to 95% and greatly reduces chance of run-outs - users' most frequent restroom complaint

No Perforations

Keeps the restroom environment cleaner



Fully Enclosed / Locking Features

Reduces waste by protecting tissue from damage and eliminates pilferage

High Capacity, Hygienic Dispensing.

Single Jumbo Jr. Roll Tissue Dispenser

von Drehle Item #AE42V / AE42N

- Locking mechanism to reduce theft
- Tissue supply is completely enclosed
- Translucent cover to monitor tissue supply
- Holds one 10-inch diameter roll
- Smaller footprint for limited space areas
- Virtually indestructible
- ADA compliant

#AE42V for 3.3" cores / #AE42N for 2.3" cores



Twin Jumbo Jr. Roll Tissue Dispenser

von Drehle Item #3253 / 3662

- Locking mechanism to reduce theft
- Stub roll feature to reduce waste
- Back-up roll to reduce run-outs
- Translucent cover to monitor tissue supply
- Holds two 9-inch diameter rolls
- Virtually indestructible
- ADA compliant

#3253 for 3.3" cores / #3662 for 2.3" cores



Single 12" Jumbo Roll Tissue Dispenser

von Drehle Item #31002A

- Locking mechanism to reduce theft
- Tissue supply is completely enclosed
- Translucent cover to monitor tissue supply
- Holds one 12-inch diameter roll
- ADA compliant



Jumbo Roll Tissue Dispensers

Item #	Description	Hub Size	Dimensions H" x W" x D"	Units per Case	Cases per Pallet
AE42V	Single Jumbo Jr. Tissue Dispenser	3.0"	12.0 x 10.5 x 4.75	4	48
AE42N	Single Jumbo Jr. Tissue Dispenser	2.25"	12.0 x 10.5 x 4.75	4	48
3253	Twin Jumbo Jr. Tissue Dispenser	3.0"	11.5 x 20.5 x 4.8	4	28
3662	Twin Jumbo Jr. Tissue Dispenser	2.25"	11.5 x 20.5 x 4.8	4	28
31002A	Single 12" Jumbo Tissue Dispenser	3.0"	14.0 x 13.5 x 5.25	1	72

Item #AE42V and #3253 use the following products: PO800, 1208-8, 1209, 120VT, 2109

Item #AE42N and #3662 use the following products: 2750, 1125, 1450, 1500

Item #31002A uses the following products: 2212, 4112

✓ Reduced Maintenance Demands

✓ Reduced Chance of Run-Outs

Average
Single Roll
Tissue Dispenser

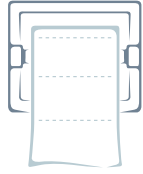

Leading
Bath Tissues
1 Roll

96 Feet
of 2-ply tissue

29 Uses
per refill

Average
Twin Roll
Tissue Dispenser



2-Ply
500 sheets (4")
2 Rolls

333 Feet
of 2-ply tissue

103 Uses
per refill

VONDREHLE
#AE42N Single
JRT Dispenser



VONDREHLE
Item #1450
1 Roll

1,450 Feet
of 2-ply tissue

447 Uses
per refill

VONDREHLE
#3253 Twin
JRT Dispenser



VONDREHLE
Item #1209
2 Rolls

2,000 Feet
of 2-ply tissue

617 Uses
per refill

VONDREHLE
#31002A Single
JRT Dispenser



VONDREHLE
Item #2212
1 Roll

2,000 Feet
of 2-ply tissue

617 Uses
per refill

Labor Saving

Change-Outs Required per 1,000 Uses



#AE42N
1 roll - #1450

2.2
Change-Outs



Leading
Bath Tissue
Equivalent

15.4
Change-Outs

600%
More
Maintenance



#3253 Twin
2 rolls - #1209

1.6
Change-Outs



Leading
Bath Tissue
Equivalent

21.3
Change-Outs

1,231%
More
Maintenance



#31002A
1 roll - #2212

1.6
Change-Outs



Leading
Bath Tissue
Equivalent

21.3
Change-Outs

1,231%
More
Maintenance

Jumbo Tissue

High Capacity in a Small Footprint.

Mini-Twin Tissue Dispenser

von Drehle Item #3275

- Locking mechanism to reduce theft
- Stub roll feature to reduce waste
- Back-up roll to reduce run-outs
- Translucent cover to monitor tissue supply
- Holds 1,500 feet of 2-ply tissue
- ADA compliant



Mini-Twin Tissue Dispensers

Item #	Description	Dimensions H" x W" x D"	Units per Case	Cases per Pallet
3275	Mini-Twin Tissue Dispenser	9.0 x 15.5 x 5.25	4	54

Item #3275 uses the following products: 2750, 1500

Variety & Versatility

2-Ply Jumbo Tissue - Soft & Absorbent

Available in **Various Lengths, Widths, and Case Counts**, these soft and absorbent jumbo tissues are made from 100% recycled fiber.

1-Ply Jumbo Tissue - Most Footage per Roll

Available in **Various Lengths**, these jumbo tissues provide the most footage per roll and are made from 100% recycled fiber.

Premium Virgin 2-Ply Jumbo Tissue

Made from 100% **Virgin Fiber**, these jumbo roll tissues are **Softer and Brighter** - perfect for high-end markets.



#AE42V



#3253



Jr. Jumbo Roll Tissue with 3.3" Core

Item #	Description	Roll Diameter	Feet per Roll	Rolls per Case	Cases per Pallet	Feet per Case
2-Ply Jr. Jumbo Roll Tissue						
PQ800	2-Ply Jr. Jumbo Roll Tissue	8.25"	800	12	48	9,600
1208-8	2-Ply Jr. Jumbo Roll Tissue	9.0"	1,000	8	60	8,000
1209	2-Ply Jr. Jumbo Roll Tissue	9.0"	1,000	12	48	12,000
120VT	2-Ply Virgin Jr. Jumbo Tissue	9.0"	1,000	12	48	12,000
1-Ply Jr. Jumbo Roll Tissue						
2109	1-Ply Jr. Jumbo Roll Tissue	9.0"	2,000	12	48	24,000

#AE42N



#3662



Jr. Jumbo Roll Tissue with 2.3" Core

Item #	Description	Roll Diameter	Feet per Roll	Rolls per Case	Cases per Pallet	Feet per Case
2-Ply Jumbo Roll Tissue						
2750	2-Ply Jr. Jumbo Roll Tissue	7.5"	750	12	55	9,000
1125/12	2-Ply Jr. Jumbo Roll Tissue	9.25"	1,125	12	48	13,500
1450	2-Ply Jr. Jumbo Roll Tissue ¹⁾	9.75"	1,450	6	56	8,700
1-Ply Jr. Jumbo Roll Tissue						
1500	1-Ply Jr. Jumbo Roll Tissue	7.5"	1,500	12	55	18,000

¹⁾ Item #1450 for use with dispenser #AE42N only.

12" Jumbo Roll Tissue with 3.3" Core

#31002A



Item #	Description	Roll Diameter	Feet per Roll	Rolls per Case	Cases per Pallet	Feet per Case
2-Ply Jumbo Roll Tissue						
2212	2-Ply Jumbo Roll Tissue	12.0"	2,000	6	48	12,000
1-Ply Jumbo Roll Tissue						
4112	1-Ply Jumbo Roll Tissue	12.0"	4,000	6	48	24,000

#3275



Mini-Twin Tissue with 2.3" Core

Item #	Description	Roll Diameter	Feet per Roll	Rolls per Case	Cases per Pallet	Feet per Case
2-Ply Jumbo Roll Tissue						
2750	2-Ply Jumbo Roll Tissue	7.5"	750	12	55	9,000
1-Ply Jumbo Roll Tissue						
1500	1-Ply Jumbo Roll Tissue	7.5"	1,500	12	55	18,000



= Green Seal™ Certified GS-1



= Made from 100% recycled fiber

The Cost-Effective, High Capacity,
Tissue Solution...

In a Space-Saving Design.



Porta-Roll Tissue Systems

- ✓ Stub Roll Features = **Reduce waste**
- ✓ 15-inch Perforations = **Reduce usage**
- ✓ More Footage per Roll = **Reduce maintenance**

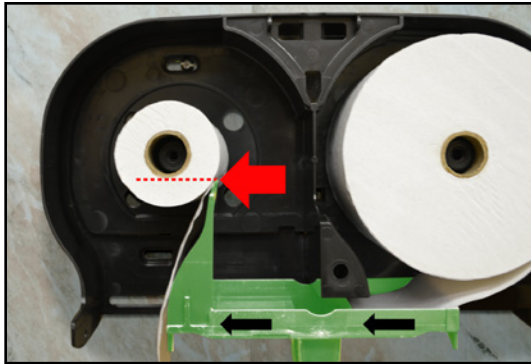

Stub Roll Features

Access control mechanisms eliminate stub roll waste and ensure full use of tissue rolls

15" Perforations

Reduces usage and keeps the restroom environment cleaner



More Footage per Roll

Reduces maintenance demands by up to 93%

Fully Enclosed / Locking Features

Reduces waste by protecting tissue from damage and eliminates pilferage



High Capacity, Hygienic Dispensing.

Twin Porta-Roll Roll Tissue Dispenser

von Drehle Item #3200

- Locking mechanism to reduce theft
- Stub roll feature to reduce waste
- Back-up roll to reduce run-outs
- Holds up to 940 feet of 2-ply tissue
- High capacity in a small footprint
- ADA compliant



3-Roll Carousel Porta-Roll Dispenser

von Drehle Item #3342

- Locking mechanism to reduce theft
- Back-up rolls to prevent run-outs
- Stub roll feature to reduce waste
- Holds up to 1,260 feet of 2-ply tissue
- Easy-turn knob to advance rolls
- ADA compliant



Porta-Roll Tissue Dispensers

Item #	Description	Dimensions H" x W" x D"	Units per Case	Cases per Pallet
3200	Twin Porta-Roll Tissue Dispenser	7.5 x 13.0 x 4.8	4	60
3342	3-Roll Carousel Porta-Roll Dispenser	16.5 x 14.5 x 9.5	1	144

Item #3200 uses the following products: PR350, PR420, PR420VT, PR470, PR750, PR940

Item #3342 uses the following products: PR350, PR420, PR420VT, PR750



Porta-Roll High Capacity Bath Tissue

Item #	Description	Feet per Roll	Rolls per Case	Cases per Pallet	Feet per Case
2-Ply Porta-Roll Bath Tissue					
PR350	2-Ply Porta-Roll High Capacity Bath Tissue	350	24	55	8,400
PR420	2-Ply Porta-Roll High Capacity Bath Tissue	420	24	55	10,080
PR470	2-Ply Porta-Roll High Capacity Bath Tissue	470	24	55	11,280
1-Ply Porta-Roll Bath Tissue					
PR750	1-Ply Porta-Roll High Capacity Bath Tissue	750	24	55	18,000
PR940	1-Ply Porta-Roll High Capacity Bath Tissue	940	24	55	22,560
2-Ply Premium Virgin Porta-Roll Bath Tissue					
PR420VT	2-Ply Porta-Roll Premium Virgin Bath Tissue	420	24	55	10,080

✓ Reduced Maintenance Demands

✓ Reduced Chance of Run-Outs

Average Single Roll
Tissue Dispenser

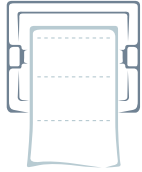

Leading Bath Tissues
1 Roll

96 Feet
of 2-ply tissue

29 Uses
per refill

Average Twin Roll
Tissue Dispenser



2-Ply 500 sheets (4")
2 Rolls

333 Feet
of 2-ply tissue

103 Uses
per refill

VONDREHLE
Twin Dispenser



von Drehle 2-Ply #PR470
2 Rolls

940 Feet
of 2-ply tissue

290 Uses
per refill

VONDREHLE
Carousel Dispenser



von Drehle 2-Ply #PR420
3 Rolls

1,260 Feet
of 2-ply tissue

389 Uses
per refill

Space Saving

55% Smaller Footprint
than twin jr. jumbo tissue dispenser



27% Less Storage Space

27% more tissue per case cube
than standard bath tissue

Everyday Value Items



Preserve® 2-Ply Household Roll Towels von Drehle Item #4100

- 2-ply for increased strength
- Embossed for increased absorbency
- 85 sheets per roll (11" x 9")
- Green Seal™ Certified

Preserve Plus® Multi-Purpose Household Roll Towels von Drehle Item #4215

- Multi-purpose - handles the tough jobs
- Stronger and more absorbent
- Comparable to the leading premium brand
- 85 sheets per roll (11" x 9")



Precious® Boxed Facial Tissue von Drehle Item #8575



- 2-ply for increased strength and absorbency
- Designed for use alone or in countertop dispensers
- 100 sheets per box (8" x 8")
- Made from 100% recycled fiber

Household Towels & Facial Tissue

Item #	Description	Sheet Size	Sheets per Roll	Rolls/Boxes per Case	Cases per Pallet	Sheets per Case
4100	Preserve® Household Roll Towels	11.0" x 9.0"	85	30	24	2,550
4215	Preserve Plus® Multi-Purpose Roll Towels	11.0" x 9.0"	85	15	48	1,275
8575	Precious® Boxed Facial Tissue	8.0" x 8.0"	100	30	70	3,000



DRC Linen Replacement Flat Napkin

von Drehle Item #R1045

- Bright white, 16-inch by 16-inch, linen-like disposable napkin
- Quality and performance of real linen at a fraction of the cost
- Soft enough for facial use, yet strong enough to absorb grease



White Beverage Napkins

von Drehle Item #1919

- 4.5" x 4.5" folded
- 9.0" x 9.0" unfolded
- 4,000 per case

Vertical or Horizontal Mini Folds

von Drehle Dispensers #265AO & #154AO

- White, Natural, or Premium TAD Mini Folds
- Can be mounted vertically or horizontally
- Uses economical 6" x 9.25" Mini Folds



Mini Centerpull Napkins

von Drehle Dispenser Item #2644

- Dispenses one napkin at a time
- White, 5.2-inch by 15-inch 2-ply napkins
- Holds 300 feet (240 large napkins)

Napkins

Item #	Description	Use with Dispenser	Napkins per Case	Cases per Pallet
R1045	DRC White Flat Napkin	-	1,000	30
1919	White Beverage Napkin	-	4,000	80
545-W	White Mini Fold / Napkin	265AO, 154AO	8,000	49
545-K	Natural Mini Fold / Napkin	265AO, 154AO	8,000	49
545-T	Premium TAD Mini Fold / Napkin	265AO, 154AO	5,600	49
CP352	2-Ply White Mini Centerpull Napkin	2644	5,760	45

Quick Reference Guide by Item Number

- Towels -

1077T	11
400AL+	11
4100	46
4215	46
4400	11
524-W	26
52W250	11, 48
540-K	26
540-W	26
545-K	26
545-T	26
545-W	26
548-K	26
548T	26
548-W	26
5752T	11
65076	11
6602T	11
7501W	11
810B	22
810N	22
816B	22
816N	22
816T	22
828B	15
828N	15
835-B	15, 19
835-N	15, 19
860-B	15, 19
860-N	15, 19
863B	15
863N	15
880-B	15, 19
880-N	15, 19
88012-B	15, 19
88012-N	15, 19
88012T	15, 19
88106-B	15
88106-N	15
88115-B	15
88115-N	15
88115T	15
8888K	11
9901T	11
CP264	11
CP300T	11
CP320	11
CP352	11
CP550T	11
CP600	11
CP73	11, 48

- Tissue -

1001	35
1125/12	41
1209	41
1208-8	41
120VT	41
1450	41
1500	41
2109	41
2212	41
2750	41
3302	35
4112	41
4521	35
4537	35
5022	35
5501	35
6022	35
65048	35
65098	35
8215	35
8575	46
9455	35
PQ800	41
PR350	44
PR420	44
PR420VT	44
PR470	44
PR750	44
PR940	44
RR123	35
RR600	35
RT500	35

-Napkins -

1919	47
545-K	47
545-T	47
545-W	47
CP352	47
R1045	47

- Wipers -

52W250	11, 48
CP73	11, 48
S900	48
S901	48
S902	48
R930	48
R931	48
R932	48
R935	48

- Wipers Continued -



S910	48
S915	48
S920	48
R940	48
R941	48
R943	48

- Dispensers -

1061	21
1080E	21
154AO	25
175AO	24
185AOW	24
2245	17
2245W	17
25000	34
2644	10
265AO	25
31002A	38
3200	44
3253	38
3275	40
3342	44
3467	14
3467SP	14
3662	38
6525M	10
6622	10
8080E	17
80BBW	10
8838	13
8838W	13
8864	13
8864W	13
8897	13
8897W	13
AE42N	38
AE42V	38
CT405	34

- Adapters -

0036660	25
545-ADP	25
MPSSR	27
SHRD-CTR	27
SHRD-CTR-8864	27
SHRD-MP	27
SHRD-MP-8864	27

-  = Hands-Free Dispensing
-  = Conforms to ADA Guidelines when installed correctly. See page 28 for ADA installation guidelines.



= Green Seal™ Certified GS-1



= Made from 100% recycled fiber

VONDREHLE

VONDREHLE

Quality Towel & Tissue Products
Since 1974

Hickory, North Carolina

Cordova, NC • Natchez, MS
Maiden, NC • Memphis, TN • Las Vegas, NV • Conover, NC

T. 800-438-3631

INTEGRITY IS OUR
MOST IMPORTANT
ASSET.

www.vondrehle.com

VON-CAT2016 v1