

GREAT PRICE GREAT QUALITY



Ordering Logo Ma
Prestige Log
Clean Step Logo Scrape
Media Ma
Motif Ma
EliteGuard Logo Inla
WaterGuard Logo In
Logo Impressio
Printed Message Ma
Photo Ma
Outdoor Mat Collectio
Clean Step Scrape
Parquet Wiper Scrape
Brush T
Indoor Mat Collectio
EliteGua
WaterGua
WaterGuard Diamon
Platinum Seri
Golden Seri
Silver Seri
EcoGua
EcoGuard Diamon
Anti-Fatigue Mat Collectio

Soft Step/
Soft Step Suprem
Kneel Reli
Utility/ Food Servic
Mat Collectio
Triple-Flex Flow & Scrap
Versa-Li
Free Flow Comfo
Safety Ch



TABLE OF CONTENTS

Warranty	02	Outdoor Mat Collection	19	Anti-Fatigue Mat Collection	33
Why Floor Mats?	04	Clean Step Scraper	20	Marble Top	34
Mat Placement	04	Parquet Wiper Scraper	21	Pro Top	35
Logo & Message Mat Collection	06	Brush Tip	22	Soft Step/Air Step	36
Ordering Logo Mats	07	Indoor Mat Collection	23	Soft Step Supreme	37
Prestige Logo Mat	08	EliteGuard	24	Safe Step	38
Clean Step Logo Scraper	09	WaterGuard	25	Flex Step	39
EliteGuard Logo Inlay	10	WaterGuard Diamond	26	Kneel Relief	40
WaterGuard Logo Inlay	11	Diamond Series	27	Utility/Food Service Mat Collection	41
Photo Mats	12	Platinum Series	28	Triple-Flex Flow & Scrape	42
Printed Message Mat	14	Golden Series	29	Versa-lite	43
Media Mat	16	Silver Series	30	Free Flow Comfort	44
Motif Mat	17	EcoGuard	31	Safety Chef	45
Logo Impressions	18	EcoGuard Diamond	32	Item Number Directory	46
				Mat Care Instructions	60
				Contact Information	63



GUARDIAN FLOOR PROTECTION WARRANTY

COMPLETE SATISFACTION GUARANTEE

The following products have a lifetime* warranty:

- EliteGuard
- EliteGuard Logo Inlay
- Prestige Logo Mats
- Printed & Photorealistic Mats
- Platinum Series
- Clean Step Scraper (excluding the Logo Scraper)
- Flex Step
- Safety Chef
- Logo Impressions
- Versa-Lite
- Triple Flex Flow & Scrape
- Free Flow Comfort
- WaterGuard (Inlay & waffle/diamond pattern with rubber border)
- Pro Top

*This warranty is applicable as long as the product is properly maintained and utilized. It does not cover normal wear or improper care.

STANDARD 1-YEAR WARRANTY POLICY

Guardian warrants new products against defects in material and workmanship when used and maintained as instructed. Warranties are void under the following circumstances:

- Improper use, application or cleaning
- Normal wear
- Use of this product other than its intended purpose
- Failure due to lack of proper maintenance
- Products have been altered in any way

Guardian Floor Protection reserves the right for final determination of warranty coverage. The start date of this warranty is the date shipped from the factory. This date is validated by customer purchase order number and Guardian invoice number. The obligation under these warranties are limited to the original user and to the replacement, repair or prorated refund of the product. All items returned for warranty inspection must be labeled clearly with an RMA number, issued by our Customer Service Department at 877-620-3822.



Guardian Floor Protection is proud to offer select products featuring the NFSI "High Traction" certification.

According to the National Safety Council (NSC), falls are the leading cause of accidental death for people of 85 or older. NFSI (National Floor Safety Institute) reports that the annual cost of slip and fall accidents tops \$100 billion dollars each year. NFSI is committed to improving pedestrian safety and in turn reduce the current trend of slip and fall accidents. For a product to gain NFSI certification, it must pass a higher benchmark than what currently exists in the industry. The two steps to NFSI certification are as follows:

Step 1: Laboratory Testing

Once our mats were sent to NFSI, they underwent initial testing with the NFSI UWT (Universal Walkway Tester). The mats were wet tested for Static Coefficient of Friction (SCOF) under NFSI 101A guidelines. After meeting the NFSI standard for slip resistance, they were eligible for Step 2 Testing.

Step 2: Field Testing

A NFSI technician then places our Guardian mats in a "real world application" or test site for a minimum of 30 days. After the 30 days, a member of the NFSI technical test team inspects and prepares the test area for testing the product again with the UWT. If the product meets or exceeds the minimum acceptable value, it will become certified as High Traction. We are proud to say that our mats exceeded the minimum suggested value and are appraised as High Traction!

For more information about NFSI and their safety work and goals, please visit their website at www.nfsi.org.

- Ordering Logo Ma
- Prestige Log
- Clean Step Logo Scrape
- Media Ma
- Motif Ma
- EliteGuard Logo Inl
- WaterGuard Logo Inl
- Logo Impress
- Printed Message Ma
- Photo Ma
- Outdoor Mat Collectio
- Clean Step Scrape
- Parquet Wiper Scrape
- Brush T
- Indoor Mat Collectio
- EliteGuard
- WaterGuard
- WaterGuard Diamon
- Platinum Serie
- Golden Serie
- Silver Serie
- EcoGuard
- EcoGuard Diamon
- Anti-Fatigue Mat Collectio
- Marble To
- Pro To
- Safe Ste
- Flex Ste
- Soft Step/ Air Ste
- Soft Step Supre
- Kneel Reli
- Utility/ Food Service
- Mat Collectio
- Triple-Flex Flow & Scrap
- Versa-Li
- Free Flow Comfo
- Safety Ch

WHY FLOOR MATS?

IMAGE

- 91% of shoppers select a store because of its appearance. (Progressive Grocer)
- When asked, "What's the first thing you look at when judging cleanliness?" the most popular first response of consumers was "Floors" (42%); "Smell" was the second (14%). (CDI Research 1991)

PROTECTION

- Without entrance matting, 1,500 people can remove 42% of the finish from a floor (3M)
- 80% of the dust, dirt and grime in public building is "tracked in" from the outside (Institute of Industrial Laundries)
- Studies show that one square yard of commercial grade carpeting can accumulate one pound of dirt over a one-week period and up to twice as much during inclement weather. (International Sanitary Supply Association)
- The estimated cost of removing a single pound of dirt from a modern building today can exceed \$500. (International Sanitary Supply Association)
- It is estimated 90% of building maintenance cost is labor. (Cleaning Management)

SAFETY

- 9 million disabling slips and falls with average \$21,000/claim (National Safety Council)
- Average cost to defend slip/fall lawsuit \$50,000 (NFSI)
- 28% of workers miss 31 days or more from same-level slips, trips and falls (Bureau of Labor Statistics)

HEALTH

- 86 billion pounds of dust settle over the U.S. each year. ("All the Real Dirt Dust", Discover Magazine)
- About 10 percent of Americans are allergic to some component of dust. (Dr. Robert Pumbhrey, Washington D.C.)
- The average six-room dwelling takes in 40 pounds of dust in a year. A private home may have between 800,000 and 1,600,000 tiny bits of dust and particulate matter in every cubic inch of air. (TRSA Report "Dust Where We Work")
- A major source of indoor air pollutants is street dust, carried in on shoes and captured in carpeting. ("The Indoor Clean Air Quality Challenge", Spray Technology Magazine)
- American businesses are spending upwards of \$100 billion a year as a result of lost worker productivity due to poor indoor air quality and "Sick Building Syndrome". (Consumer Federal of America)

MAT PLACEMENT GUIDE

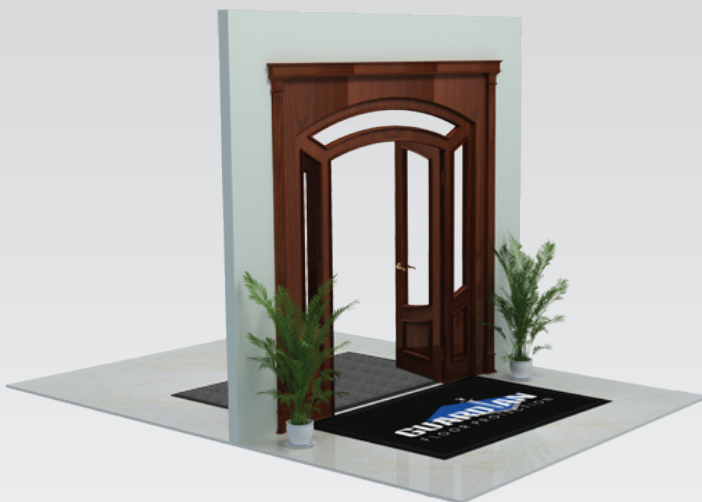

DUAL MAT SYSTEM

The best way to keep dirt and moisture from being tracked into your building is to use our dual-mat system at every entranceway: an Outdoor Mat to scrape shoes clean and an Indoor Mat to wipe shoes dry.

EARN UP TO 1 LEED POINT

Using a proper mat system at entryways to reduce dirt, dust, pollen and other particles earns 1 LEED point for your company. The U.S. Green Building Council certifies buildings as "green." Their LEED program is a voluntary, consensus-based national standard for developing high performance, sustainable buildings.



MATTING ZONES:



Entranceways



Hazardous Area



Heavy Traffic



Workstations



Logo & Message Mat Collection
 Ordering Logo Mat
 Prestige Logo
 Clean Step Logo Scrape
 Media Mat
 Motif Mat
 Guard Logo Inlay
 WaterGuard Logo Inlay
 Logo Impression
 Printed Message Mat
 Photo Mat
 Outdoor Mat Collection
 Clean Step Scrape
 Parquet Wiper Scrape
 Brush Tip
 Indoor Mat Collection
 EliteGuard
 WaterGuard
 WaterGuard Diamond
 Platinum Series
 Golden Series
 Silver Series
 EcoGuard
 EcoGuard Diamond
 Fatigue Mat Collection
 Marble Top
 Pro Top
 Safe Step
 X-Step
 Step
 Step Supreme
 Kneel Relief
 Utility/ Food Service
 Mat Collection
 Triple-Flex Flow & Scrape
 Versa-Lite
 Free Flow Comfort
 Safety Check
 U-P-Safe Mat

LOGO & MESSAGE MAT COLLECTION



MAT FACT

Printed logo and message mats are among our most popular products. These beautifully crafted, vibrant mats offer the best of high impact decor with unparalleled floor protection. Make a great and lasting impression with your logo or message on a custom-created mat!

FEATURING

Prestige Logo
Clean Step Logo
EliteGuard Logo
WaterGuard Logo
Photo Mats
Printed Message
Logo Impressions
Media Mat
Motif Mat

ORDERING LOGO MATS

GETTING YOUR OWN LOGO MAT IS AS EASY AS 1 – 2 – 3!

STEP 1: ARTWORK

We need your logo in order to create electronic files that we can place onto your mat. This can be provided in an electronic version (preferred) in either .jpeg, .tiff or .bmp. We also accept files such as .cdr and .eps. Remember, the higher the resolution the files you provide, the more accurate our designers can be when setting them in our formats necessary to print.

PREFERABLE

Black & white ad slicks
Brochures
Magazine ads
Camera ready artwork

MARGINAL

Color prints
Business cards
Business literature
Letterheads

UNACCEPTABLE

Faxes
Newspaper ads
Yellow Page ads
Photographs
Banners / Flags
Embossed materials
Metallic materials
Emblems

STEP 2: VISUAL REQUEST

Submit your chosen artwork via either our Guardian ordering system (log-on required) or direct with our customer service team. We will provide a visual for approval within 24 hours.

STEP 3: APPROVAL

Once your visual has been approved, you can submit your mat order (again via Guardian or with our customer service team).

53 COLOR PALETTE



No need for paper order forms! Online processing is environmentally friendly.



Pick up the phone and call one of our helpful customer service representatives



PRESTIGE LOGO MAT



Item Listings
PG 47
Item Number
Directory

FEATURES & BENEFITS

1. Enhance the image and appearance of your business
2. Manufactured using our state-of-the-art HD ChromoJET printer
3. High-quality dyes offer brilliant color fastness and image durability
4. Choose up to 8 colors out of a 53-color palette (pg 48)
5. Create mat designs and make changes by submitting your art files to our staff of designers
6. No minimum order quantity

RUBBER BACKED BENEFITS

1. Strong rubber backing provides maximum durability for high-traffic areas
2. Sizes from 2'x3' up to 6'x20', in 1' increments
3. Available in smooth or gripper backing

VINYL BACKED BENEFITS

1. Durable chemical-resistant PVC vinyl backing is cost effective
2. PVC backing available in lengths up to 60' long
3. Available in smooth backing only

PLACEMENT

- Entranceways
- Hallways
- Lobbies
- Service Counters
- Anywhere you want your logo to be seen!

SIZE

- 2'x3'
- 3'x5'
- 3'x10'
- 4'x6'

* Available in sizes up to 6'x20', in increments of 1' (rubber backing only)

* Available in sizes up to 6' x 60', in increments of 1' (vinyl backing only)

*Listed sizes are approximate. Please see website for actual size.



CLEAN STEP LOGO SCRAPER



FEATURES & BENEFITS

1. Protect your flooring by cleaning dirt and moisture from shoes as it enters your building
2. Traps moisture and debris below walking surface
3. All-rubber construction for maximum durability
4. Textured backing keeps mat in place and helps reduce slips and falls
5. Can be recycled
6. Works great in combination with the Prestige Logo Mats

PLACEMENT

- Ideal for hard surface floors
- Entranceways
- Production areas
- Break rooms
- Kitchens
- Vending areas
- Water fountains
- Ice machines

SIZE

- 2'x3'
- 3'x5'
- 3'x10'
- 4'x6'
- 6'x6'
- 6'x8'

*Listed sizes are approximate. Please see website for actual size.



ELITEGUARD LOGO INLAY



FEATURES & BENEFITS

1. Outstanding walk-off performance for heavy, multi-directional traffic applications
2. Stain-resistant, colorfast and permanently anti-static
3. Logo designs are cut and sewn into base for impeccable image presentation
4. Beveled edges for additional stability
5. No limitations on size
6. Green Label Plus certified
7. Certified 'High Traction' by the National Floor Safety Institute (NFSI)

PLACEMENT

- Hotels
- Hospitals / Healthcare
- Retail stores
- Class A office buildings

SIZE

- | | |
|--------|--------|
| 3'x5' | 4'x10' |
| 3'x10' | 6'x8' |
| 4'x6' | 6'x10' |
| 4'x8' | 6'x12' |

* Any custom size available

COLORS

BASE COLORS

Autumn	Azure	Black Shadow	Burgundy
Cardinal Red	Charcoal	Chocolate	Coir/Natural
Dark Denim	Dark Forest Green	Garnet	Harvest
Hunter Green	Loden	Midnight Blue	Natural Beige
Oceanic	Prism	Rosewood	Steel Blue
Sterling	Taupe	Teak	Verona Gold
Walnut	Zinc		

LOGO INLAY COLORS

Baby Blue	Autumn
Bright Red	Gold
Kelly Green	Orange
Pink	Purple
Royal Blue	Sand
Solid Crimson	Turquoise
White	Yellow

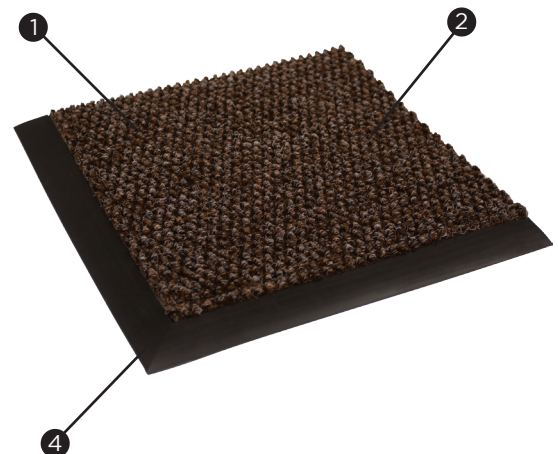

WATERGUARD LOGO INLAY



Item Listings
PG 48
Item Number
Directory

FEATURES & BENEFITS

1. Texturized carpet scrapes dirt and debris off of shoes
2. Backing is made from 100% rubber construction for maximum durability
3. Dirt and water are trapped by rubber reinforced polypropylene carpet ridges
4. Images are created via a unique inlay method, creating a crisp, clean logo
5. Simple to clean, just vacuum or hose off
6. Certified 'High Traction' by the National Floor Safety Institute (NFSI)

PLACEMENT

- Indoor and outdoor entranceways
- Vending areas
- Kitchens
- High traffic doorways
- Production areas

SIZE

2'x3'	4'x8'
3'x4'	4'x10'
3'x5'	4'x12'
3'x8'	4'x16'
3'x10'	4'x20'
3'x12'	6'x8'
3'x16'	6'x12'
3'x20'	6'x16'
4'x6'	6'x20'

*Listed sizes are approximate. Please see website for actual size.

COLORS

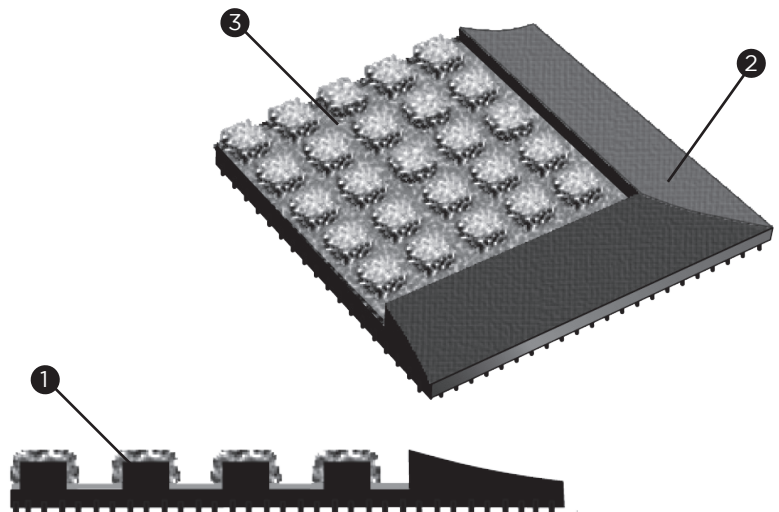



**ASK ABOUT
OUR HIGH
DEFINITION
PRINTING**

Item Listings
PG 49
Item Number
Directory

FEATURES & BENEFITS

1. State-of-the-art printing process provides eye-catching clarity
2. Protects floor and carpeting
3. Prevents the spread of spills, promoting safety
4. 100% Nitrile rubber backing for maximum durability
5. Cleated backing for reduced mat movement
6. Certified 'High Traction' by the National Floor Safety Institute (NFSI)

PLACEMENT

- Restaurants
- Grocery stores
- Ice machines
- Kitchens
- Break rooms
- Coffee stations

SIZE

- Coffee Mats (3'x5')
- Ice Mats (3'x5')
- Motivational Mats (3'x5')
- Grocery Mats (3'x10')
- Safety & Quality Mats (3'x5')

*Listed sizes are approximate. Please see website for actual size.



DESIGNS

COFFEE MAT 3'X 5'



ICE MAT 3'X 5'



MOTIVATIONAL MATS 3'X 5'

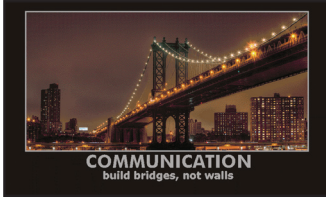

GROCERY MATS 3'X10'



SAFETY AND QUALITY MATS 3'X 5'

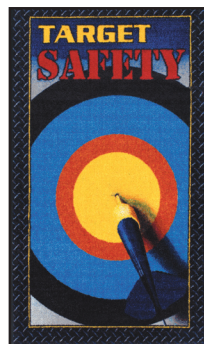
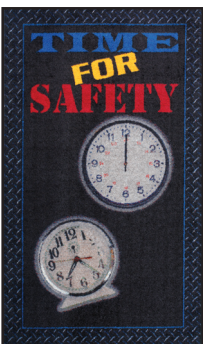
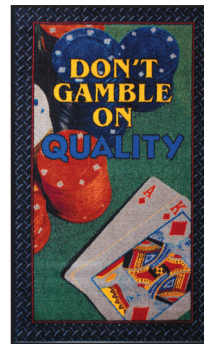
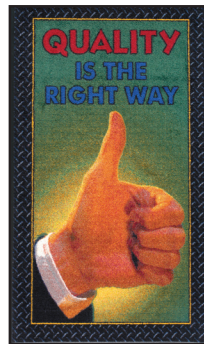
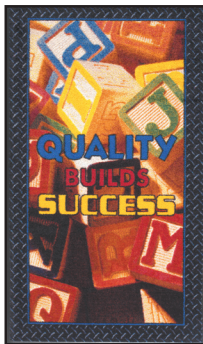

PRINTED MESSAGE MAT



**WE CAN
CREATE ANY
LINE OF CUSTOM
MESSAGE
MATS TO FIT
YOUR NEEDS**

 **Item Listings
PG 48
Item Number
Directory**

FEATURES & BENEFITS

1. Enhance the image and appearance of your business
2. Produced with high-quality dyes, giving vibrant color and clarity to your message mat
3. Protects floor and carpeting
4. 100% rubber backing for maximum durability
5. Certified 'High Traction' by the National Floor Safety Institute (NFSI)

PLACEMENT

- Restaurants
- Grocery stores
- Ice machines
- Kitchens
- Break rooms
- Coffee stations

SIZE

- Daycare Mats (3'x5')
- Water Mats (3'x5')
- Anti-Drug Mats (3'x5' & 4'x6')
- Safety Mats (3'x5')

*Listed sizes are approximate. Please see website for actual size.

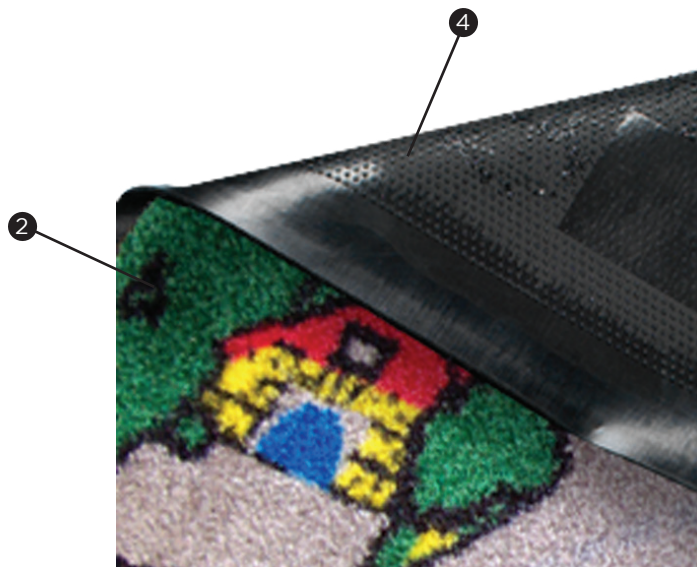

DESIGNS

DAYCARE MATS 3'X 5'

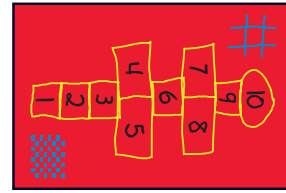
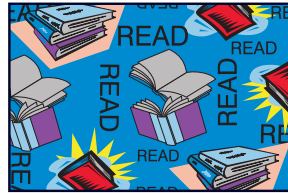
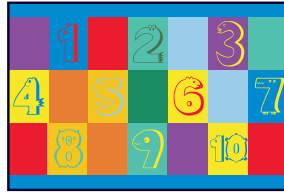
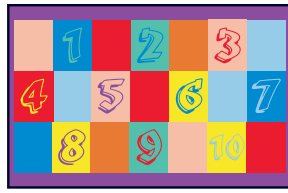

DAYCARE MATS 3'X 5'

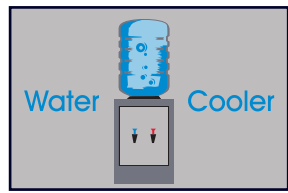

ANTI-DRUG MATS 3'X 5' AND 4'X 6'



SAFETY MATS 3'X 5'

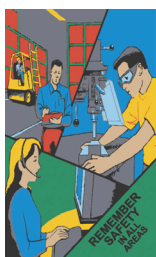

MEDIA MAT



FEATURES & BENEFITS

1. Eye-catching promotional material
2. Display message and brand with photo quality
3. Clear laminate for an easy to clean surface
4. All-rubber construction for excellent durability
5. Abrasion-resistant surface
6. Great for short term or mobile events and displays
7. No adhesive required allows the Media Mat to be very maneuverable
8. Available in smooth or textured backing

PLACEMENT

- Displays
- Checkout counters - in front or even on top
- Customer service counters
- Trade shows
- Offices
- Convenience stores
- Any surface you want your logo or message to be seen!

SIZE

- 2'x3'
 - 3'x4'
 - 3'x5'
 - 4'x6'
- * Additional sizes available upon request (up to 10' long)*



MOTIF MAT



FEATURES & BENEFITS

1. Open-faced, 100% printed nylon carpet covered mat
2. Non-skid, 100% recycled vinyl backing
3. Chemical-resistant backing provides durability and stability
4. Serged edges make for a clean finish and additional strength
5. Choose up to 8 colors out of a 53-color palette (pg 48)
6. True ChromoJET printed colors for ideal clarity

PLACEMENT

- Ideal for hard surface floors
- Low-traffic entranceways
- Hallways
- Lobbies
- Service counters
- Anywhere you want your logo or message to be seen!

SIZE

2'x3'
3'x4'

* Additional sizes available up to 50" in width and 96" in length

* Listed sizes are approximate. Please see website for actual size.



3

4



FEATURES & BENEFITS

1. Logo is permanently molded into the mat – giving you a clean, professional image
2. Bi-level construction traps moisture and dirt on contact
3. 100% UV resistant polypropylene fabric for outdoor placements
4. All-rubber backing provides maximum durability
5. Rubber reinforced surface ridges scrape shoes clean and can withstand heavy traffic areas
6. Cleated backing for stability and water aeration
7. Simple to clean, just vacuum or hose off
8. Impressions can be created for WaterGuard and EcoGuard Mats*

PLACEMENT

- Indoor and outdoor entranceways
- High traffic doorways
- Vending areas
- Kitchens
- Production areas
- Anywhere you want your logo to be seen!

SIZE

- 2'x3'
- 3'x4'
- 3'x5'
- 3'x10'
- 4'x6'
- 4'x8'

* Only Blue, Brown, Charcoal and Green colors are available for the EcoGuard Mat

*Listed sizes are approximate. Please see website for actual size.

COLORS

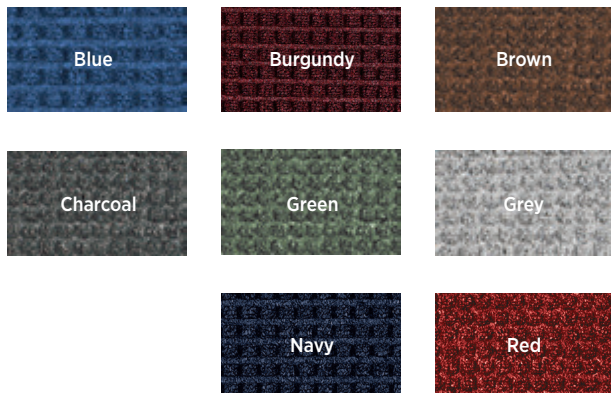

OUTDOOR MAT COLLECTION



MAT FACT

Outdoor matting is your first line of defense against dirt and moisture. These mats are designed to scrape shoes clean of heavy debris that would otherwise find its way into your facility. Protect the longevity of your floors by removing dirt from foot traffic before it even hits the door.

FEATURING

Clean Step Scraper
Parquet Wiper Scraper
Brush Tip

CLEAN STEP SCRAPER

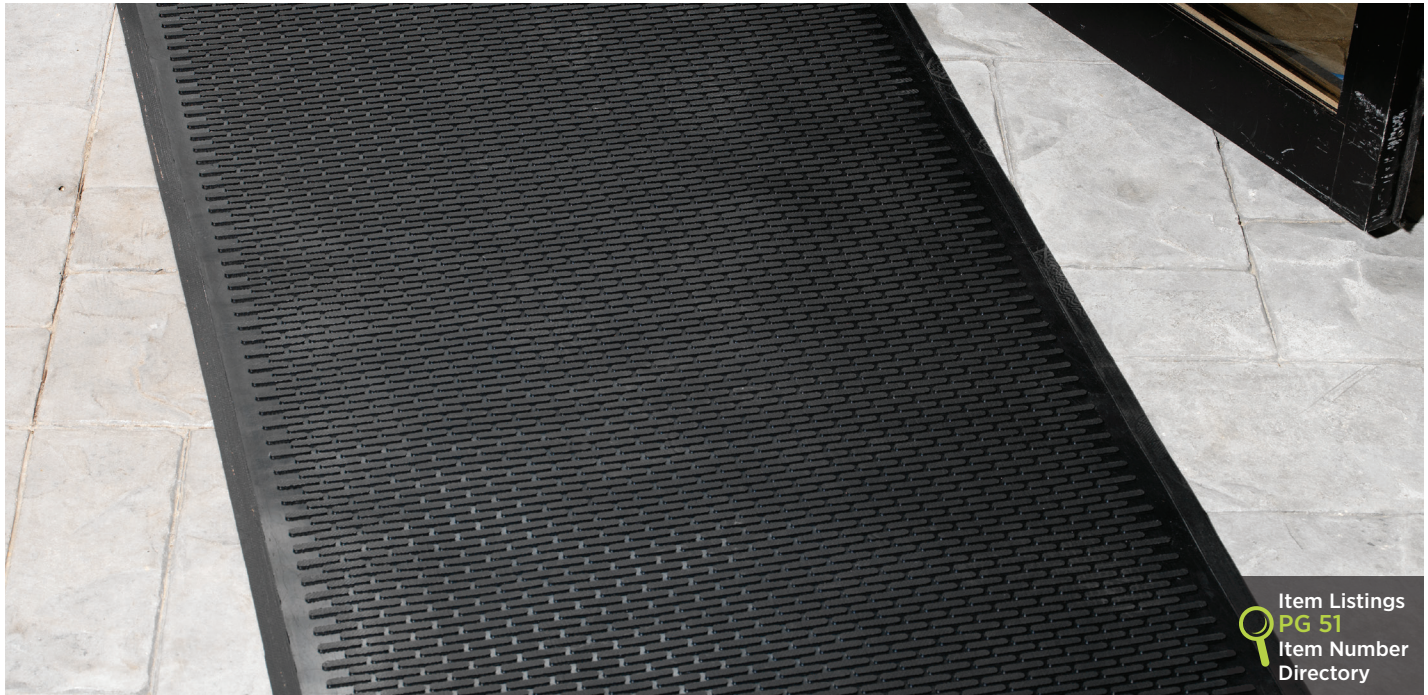

Item Listings
PG 51
Item Number
Directory

FEATURES & BENEFITS

1. Superior molded tread aggressively scrapes shoes clean and traps debris in the base of the mat
2. All-rubber construction for maximum durability
3. Textured backing keeps mat in place
4. Beveled edges for additional safety and prevention of slips and falls
5. Made with natural rubber
6. Recyclable for reuse of materials
7. Certified 'High Traction' by the National Floor Safety Institute (NFSI)
8. Thickness: 5/16"

PLACEMENT

- Entranceways
- Production areas
- Break rooms
- Kitchens
- Vending areas
- Water fountains
- Ice machines

SIZE

- 2'x3'
- 3'x5'
- 3'x10'
- 4'x6'

*Listed sizes are approximate. Please see website for actual size.

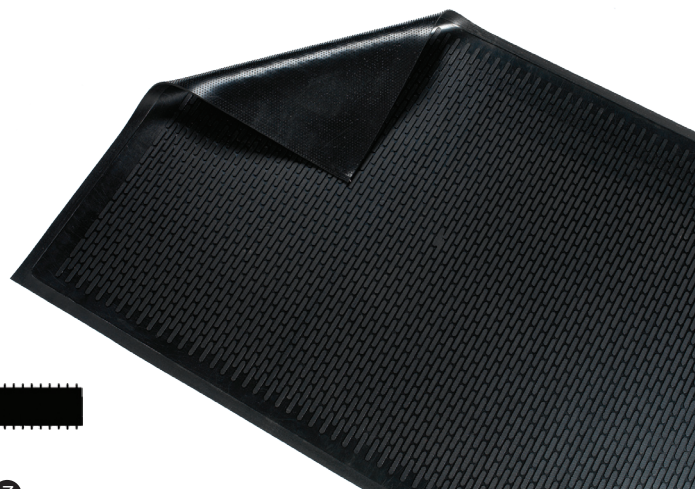
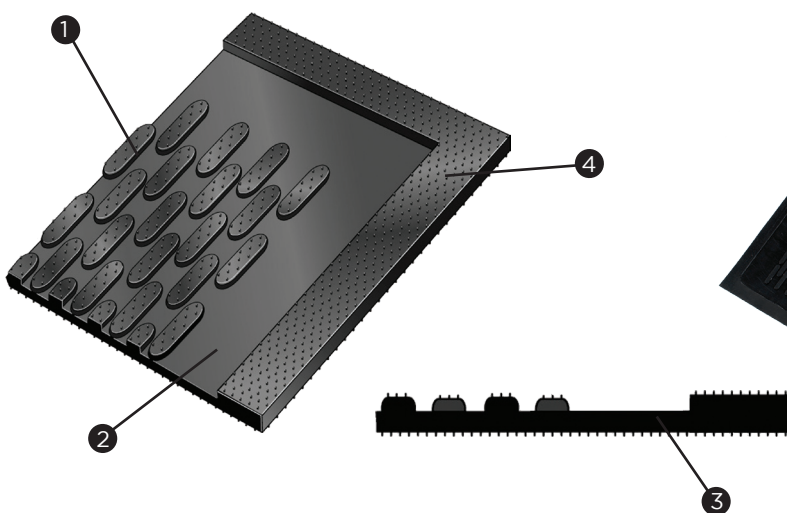

PARQUET WIPER SCRAPER

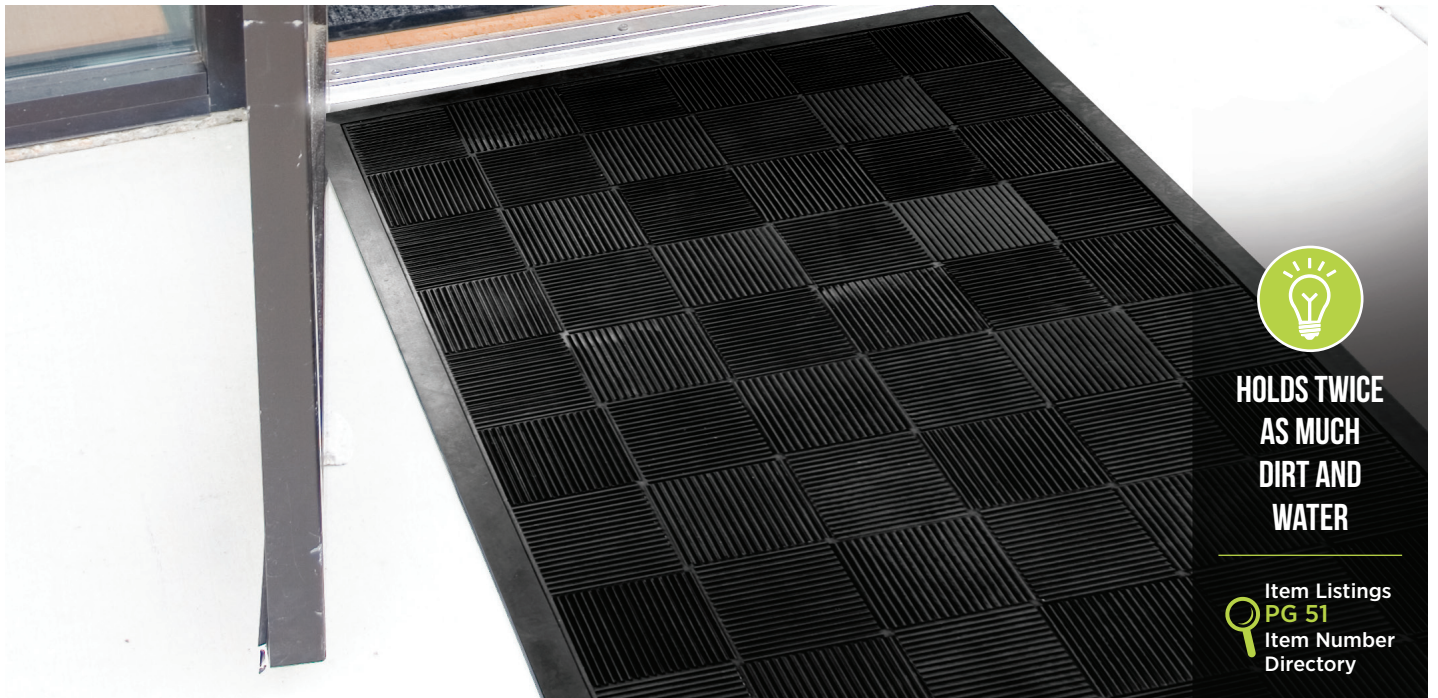

**HOLDS TWICE
AS MUCH
DIRT AND
WATER**

Item Listings
PG 51
Item Number
Directory

FEATURES & BENEFITS

1. Systematic parquet square pattern (each rotated 90°) to remove dirt and handle multi-direction traffic
2. Large water pan area to hold excess water
3. Flexible blades to scrape shoes and add anti-fatigue properties
4. Beveled edges allow for easy transition from floor to mat
5. Holds twice the amount of dirt and water than a normal scraper mat
6. Recyclable
7. Certified 'High Traction' by the National Floor Safety Institute (NFSI)
8. Thickness: 3/8"

PLACEMENT

- Entranceways
- Production areas
- Break rooms
- Kitchens
- Vending areas
- Water fountains
- Ice machines

SIZE

2'x3'
3'x5'

*Listed sizes are approximate. Please see website for actual size.

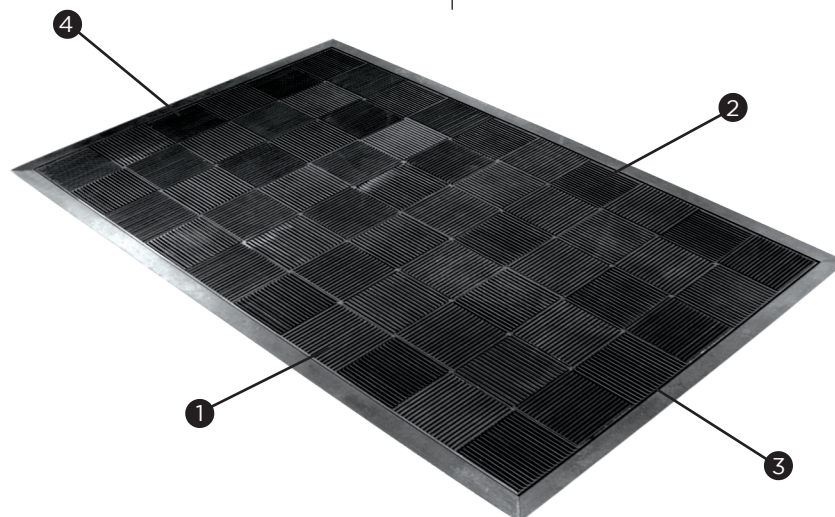



FEATURES & BENEFITS

1. Improved brush strength
2. Bristles scrape dirt and debris off of shoes
3. Dirt and water are held in reservoir
4. Slip-resistant base helps keep mat in position
5. Beveled edges for additional safety and prevention of slips and falls
6. Easy to keep clean – just turn over, shake out, or hose off
7. Thickness: 7/16"

PLACEMENT

- Entranceways
- Production areas
- Break rooms
- Kitchens
- Vending areas
- Water fountains
- Ice machines

SIZE

- 24"x32"
- 32"x39"
- 36"x72"

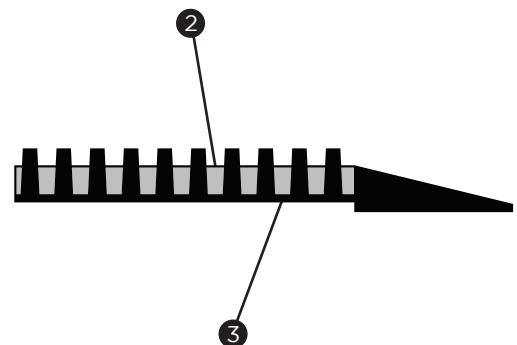
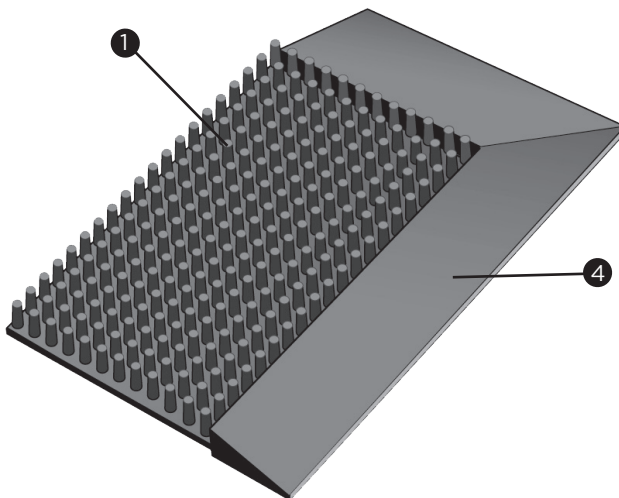

INDOOR MAT COLLECTION



MAT FACT

Indoor matting collects moisture and debris from shoes as they enter your building, keeping your facility clean from dirt. We offer a wide variety of Indoor mats, as well as patterns and colors to choose from. They are a must for any indoor entryway.

FEATURING

EliteGuard
WaterGuard
WaterGuard Diamond
Diamond Series
Platinum Series
Golden Series
Silver Series
EcoGuard
EcoGuard Diamond



Item Listings
PG 52
Item Number
Directory

FEATURES & BENEFITS

1. Outstanding walk-off performance for heavy, multi-directional traffic applications
2. Stain-resistant, colorfast and permanently anti-static
3. Bi-level construction traps dirt and debris below the walking surface keeping your floor clean
4. Beveled edges for additional stability
5. Easily maintained by vacuuming and periodic extraction
6. Custom cuts that can be seamed and tailored to fit most any specific dimension
7. Green Label Plus certified
8. Certified 'High Traction' by the National Floor Safety Institute (NFSI)

PLACEMENT

- Entranceways
- Indoor and outdoor
- High-traffic areas
- Vestibules and revolving doors

SIZE

- 3'x5'
- 3'x10'
- 4'x6'
- 4'x8'
- 4'x10'
- 6'x8'
- 6'x10'
- 6'x12'

* Any custom size and shape available

COLORS

Autumn	Azure	Black Shadow	Burgundy	Cardinal Red
Charcoal	Chocolate	Coir/Natural	Dark Denim	Dark Forest Green
Garnet	Harvest	Hunter Green	Loden	Midnight Blue
Natural Beige	Oceanic	Prism	Rosewood	Steel Blue
Sterling	Taupe	Teak	Verona Gold	Walnut
Zinc				

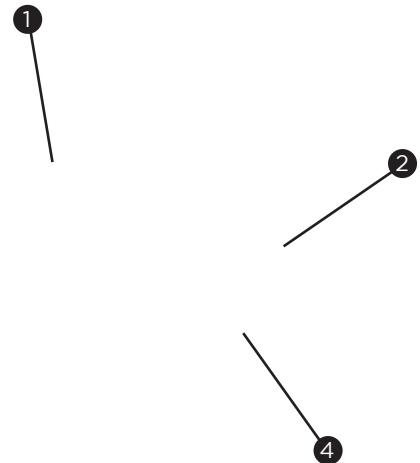



Item Listings
PG 52
Item Number
Directory

FEATURES & BENEFITS

1. Rubber reinforced polypropylene carpet ridges traps dirt and water and includes 24 oz fibers for superior absorbency
2. 100% rubber backing for maximum durability
3. Recommended as an indoor mat but substitutes as an outdoor mat in warm to moderate climates
4. Simple to clean, just vacuum or hose off
5. Not recommended for use in areas exposed to grease or petroleum products. Passes flammability standards DOCFPI-70
6. Available in smooth backing for hard surfaces or gripper backing for carpeted surfaces

PLACEMENT

- Indoor and outdoor entranceways
- Ice machines
- Vending areas
- Kitchens
- Break rooms
- High traffic doorways
- Production areas

SIZE

2'x3'	4'x6'
3'x4'	4'x8'
3'x5'	4'x10'
3'x10'	4'x12'
3'x12'	4'x20'
3'x20'	6'x8'

* Additional sizes available

* Listed sizes are approximate. Please see website for actual size.

COLORS

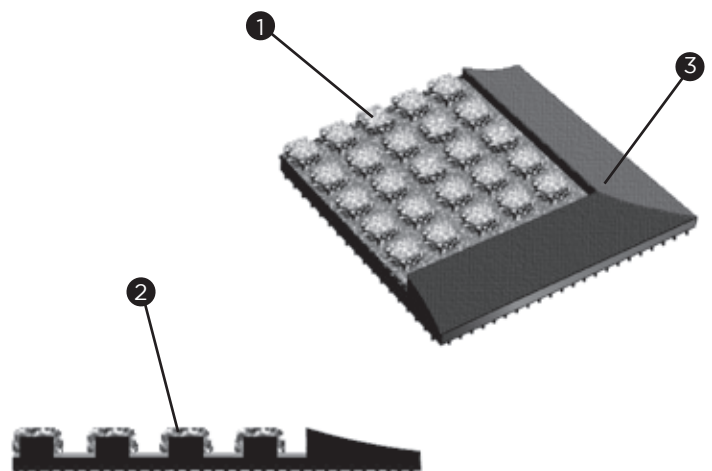
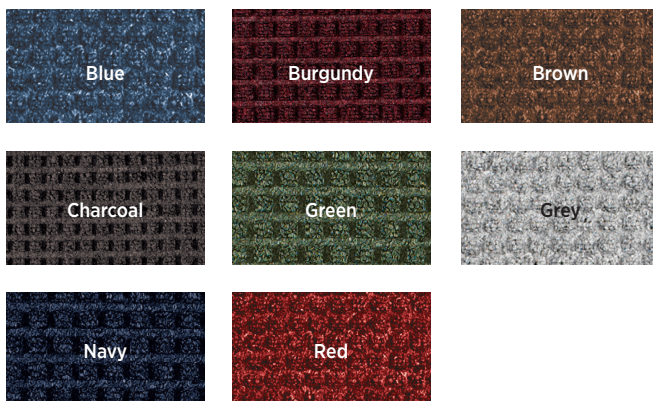

WATERGUARD DIAMOND



Item Listings
PG 52
Item Number
Directory

FEATURES & BENEFITS

1. 24 oz fibers for superior absorbency
2. Rubber backing is 40% thicker on fabric border mats for maximum durability in high traffic areas
3. Beveled edge reduces trips and falls
4. Possesses many of the same features and benefits as the standard WaterGuard
5. Available with a rubber or fabric border - fabric border has optional fanned ends for a more elegant look
6. Extended warranty applies only to rubber border WaterGuard Diamond products
7. Available in smooth backing for hard surfaces or gripper backing for carpeted surfaces

PLACEMENT

- Indoor and outdoor entranceways
- Ice machines
- Vending areas
- Kitchens
- Break rooms
- High traffic doorways
- Production areas

SIZE

2'x3'	3'x20'	4'x20'
3'x4'	4'x6'	6'x8'
3'x5'	4'x8'	6'x10'
3'x10'	4'x10'	6'x12'
3'x12'	4'x12'	6'x14'
3'x14'	4'x14'	6'x16'
3'x16'	4'x16'	6'x20'

*Listed sizes are approximate. Please see website for actual size.

COLORS

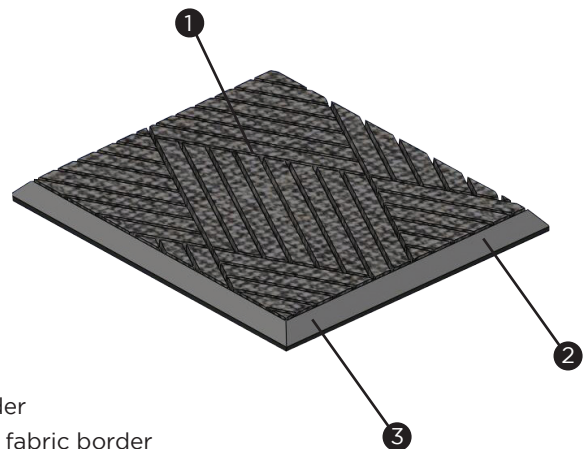

Available in:

- Half Oval - fabric border
- Diamond double fan - fabric border
- Diamond single fan - fabric border
- Diamond - fabric border or rubber border



Item Listings
PG 54
Item Number
Directory

FEATURES & BENEFITS

1. Dual-purpose mat that is good for entrances and common walkways
2. Uniquely blended carpet features high denier black polypropylene that scrapes shoes clean, while gray nylon fiber helps to dry shoes of excess moisture
3. The durable, tufted carpet traps dirt, dust and water in the base of the mat -keeping the walking surface clear
4. Heavy-duty vinyl backing is slip and stain-resistant
5. The smooth backing is ideal for low pile carpet or hard surface floors
6. Protects flooring and promotes facility cleanliness
7. Simply vacuum on high-pile setting or shake out to clean

COLORS

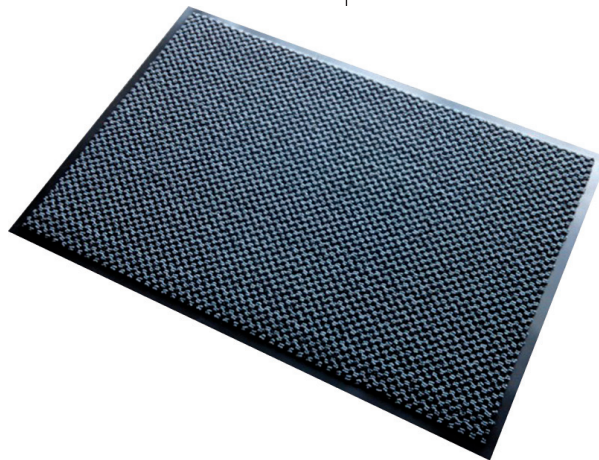

PLACEMENT

- Ideal for hard surface floors
- Entranceways
- Hallways
- Lobbies
- Service counters
- Low-traffic walkways

SIZE

- 2'x3'
- 3'x4'
- 3'x5'
- 3'x10'
- 4'x6'
- 4'x8'
- 4'x10'
- 6'x8'
- 6'x20'

* Available in rolls up to 60' in length and 3', 4' and 6' in width

* Listed sizes are approximate. Please see website for actual size.



Item Listings
PG 54
Item Number
Directory

FEATURES & BENEFITS

1. Plush, solution-dyed nylon carpet for better absorption and color fastness
2. All-rubber backing means long lasting performance and maximum durability
3. Available in smooth backing for hard surfaces or gripper backing for carpeted surfaces
4. Simple to clean, just vacuum, use a carpet cleaner or commercially wash
5. Certified 'High Traction' by the National Floor Safety Institute (NFSI)
6. Inherently Stain and Fade Resistant

PLACEMENT

- Entranceways
- Hallways
- Lobbies
- Service counters
- Office waiting areas
- High-traffic walkways

SIZE

- | | |
|--------|--------|
| 2'x3' | 4'x6' |
| 3'x4' | 4'x8' |
| 3'x5' | 4'x10' |
| 3'x10' | 4'x12' |
| 3'x12' | 4'x20' |
| 3'x20' | |

* Available in sizes up to 6'x20', in increments of 1'

COLORS

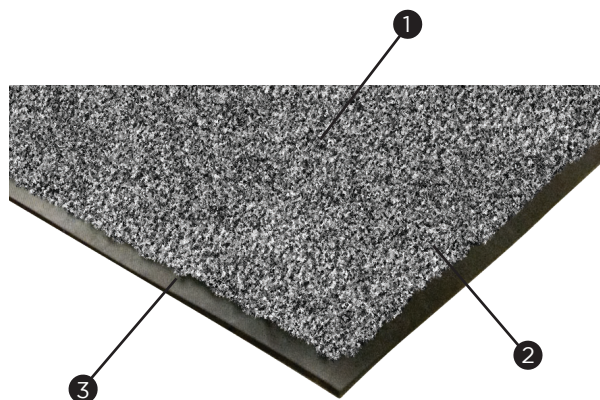

GOLDEN SERIES



Item Listings
PG 54
Item Number
Directory

FEATURES & BENEFITS

1. 100% polypropylene carpet absorbs moisture and dries quickly
2. Heavy-duty vinyl backing is slip and stain resistant
3. Cleans dirt and moisture from shoes
4. Can be used on low pile carpet or hard surface floors
5. Simply vacuum on high pile setting or shake out to clean
6. Available patterns: Dual Rib, Chevron, Hobnail and Woven

COLORS

DUAL RIB	CHEVRON	HOBNAIL	WOVEN
Beige (40)	Blue (25)	Charcoal (30)	Beige (40)
Chocolate (20)	Charcoal (30)	Green (45)	Black (10)
Green (45)	Chocolate (20)	Grey (50)	Charcoal (30)
Grey (50)	Green (45)	Maroon (55)	Green (45)
Red (35)	Red (35)	Sand (60)	Grey (50)
Blue (25)			Navy (25)
Charcoal (30)			

PLACEMENT

- Recommended for hard surface floors and low pile carpet
- Entranceways
- Hallways
- Lobbies
- Low-traffic walkways

SIZE

- 2'x3' 4'x6'
3'x4' 4'x8'
3'x5' 4'x10'
3'x6' 4'x60'
3'x10' 6'x8'
3'x60' 6'x60'

- * Available in 3', 4' and 6' widths up to 60' long in 1' increments
- * Add 10% for 60' rolls
- * Add 10% for custom cuts

PATTERNS

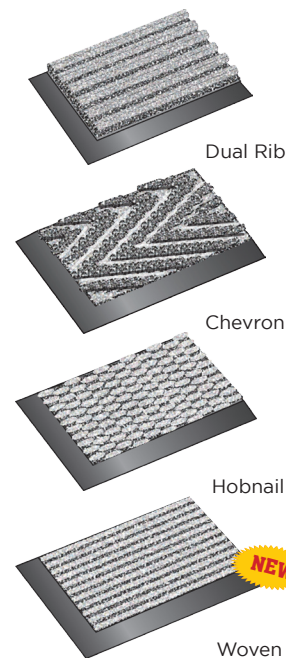

SILVER SERIES



FEATURES & BENEFITS

1. Continuous filament olefin carpet cleans dirt and moisture from shoes
2. Chemical-resistant vinyl backing
3. Smooth backing can be used on low pile carpet or hard surface floors
4. Cleans dirt and moisture from shoes
5. Protects flooring and promotes facility cleanliness

PLACEMENT

- Ideal for hard surface floors
- Entranceways
- Hallways
- Lobbies
- Service counters
- Low-traffic walkways

SIZE

- | | |
|--------|--------|
| 2'x3' | 4'x6' |
| 3'x4' | 4'x8' |
| 3'x5' | 4'x10' |
| 3'x6' | 4'x60' |
| 3'x10' | 6'x60' |
| 3'x60' | |

* Available in 3', 4' and 6' widths up to 60' long in 1' increments

* Add 10% for 60' rolls

* Add 10% for custom cuts

COLORS

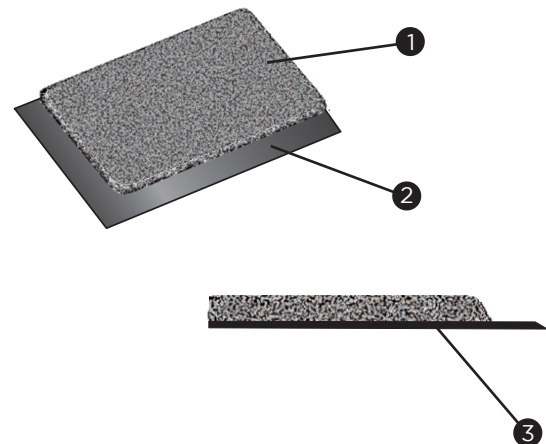
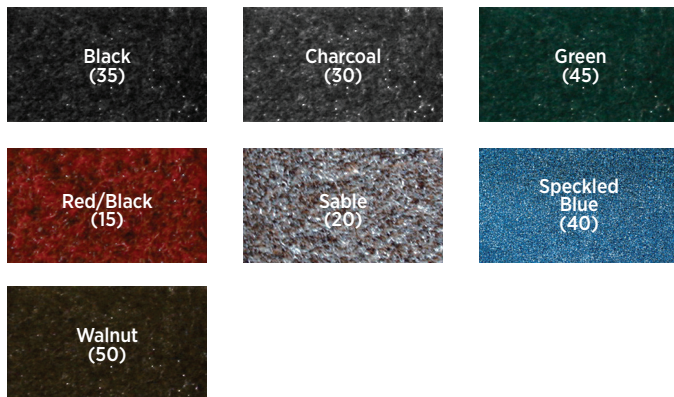



**OUR MOST
ECO-FRIENDLY
MAT EVER**

Item Listings
PG 55
Item Number
Directory

FEATURES & BENEFITS

1. Carpeted surface is made from 100% post consumer recycled drinking bottles
2. Durable crumb rubber backing is wear-resistant
3. Bi-level construction traps dirt below surface
4. Beveled edge reduces trips and falls
5. Fashionable fabric border
6. Easy to clean, just sweep, shake out, or vacuum
7. Not available with rubber border

PLACEMENT

- Recommended for hard surface floors and low pile carpet
- Entranceways
- Hallways
- Lobbies

SIZE

- 2'x3'
- 3'x4'
- 3'x5'
- 3'x10'
- 4'x6'
- 4'x8'
- 4'x10'

*Listed sizes are approximate. Please see website for actual size.

COLORS

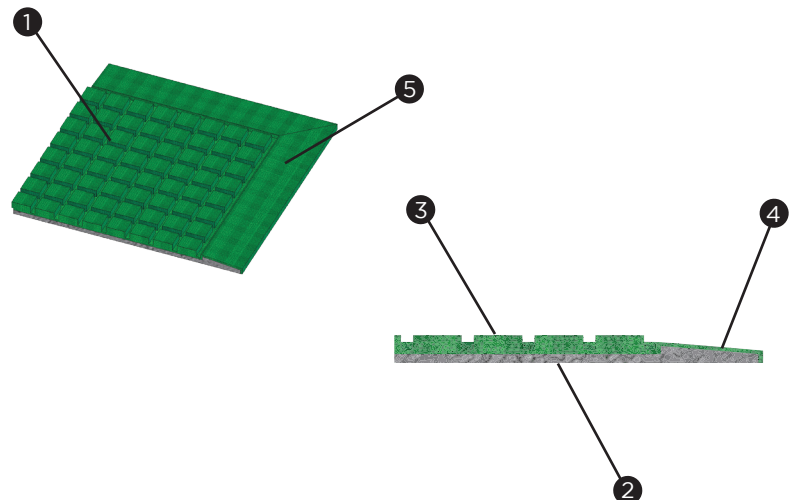
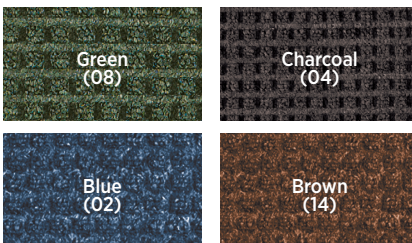

ECOGUARD DIAMOND



NEW



Item Listings
PG 56
Item Number
Directory

FEATURES & BENEFITS

1. Carpeted surface is made from 100% post consumer recycled drinking bottles
2. Durable, recycled crumb rubber backing is wear-resistant
3. Bi-level construction traps dirt below surface
4. Beveled edge reduces trips and falls
5. Fashionable fabric border
6. Available with single and double fanned ends, as well as half oval options. Not available with rubber border
7. Easy to clean, just sweep, shake out, or vacuum

PLACEMENT

- Recommended for hard surface floors and low pile carpet
- Entranceways
- Hallways
- Lobbies

SIZE

- 2'x3'
- 3'x4'
- 3'x5'
- 3'x10'
- 4'x6'
- 4'x8'
- 4'x10'

*Listed sizes are approximate. Please see website for actual size.

COLORS

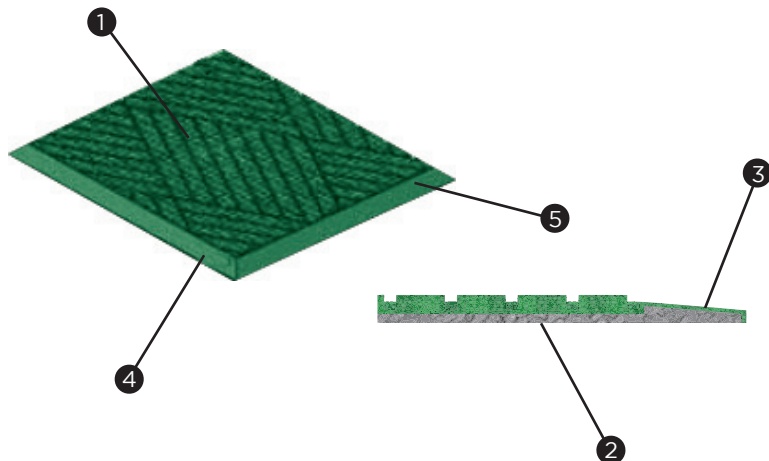
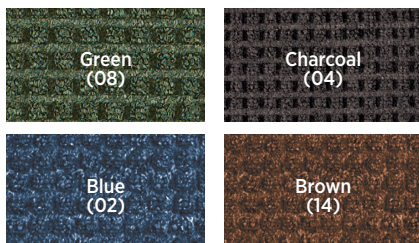

ANTI-FATIGUE MAT COLLECTION



MAT FACT

Anti-Fatigue mats are wonderful additions to areas where prolonged standing causes fatigue. Increase worker productivity and decrease injury with these mats in personal workstations. Be proactive in developing a safe, healthy, and productive environment for everyone in your facility!

FEATURING

Marble Top
Pro Top
Soft Step / Air Step
Soft Step Supreme
Safe Step
Flex Step
Comfort Step
Kneel Relief

MARBLE TOP

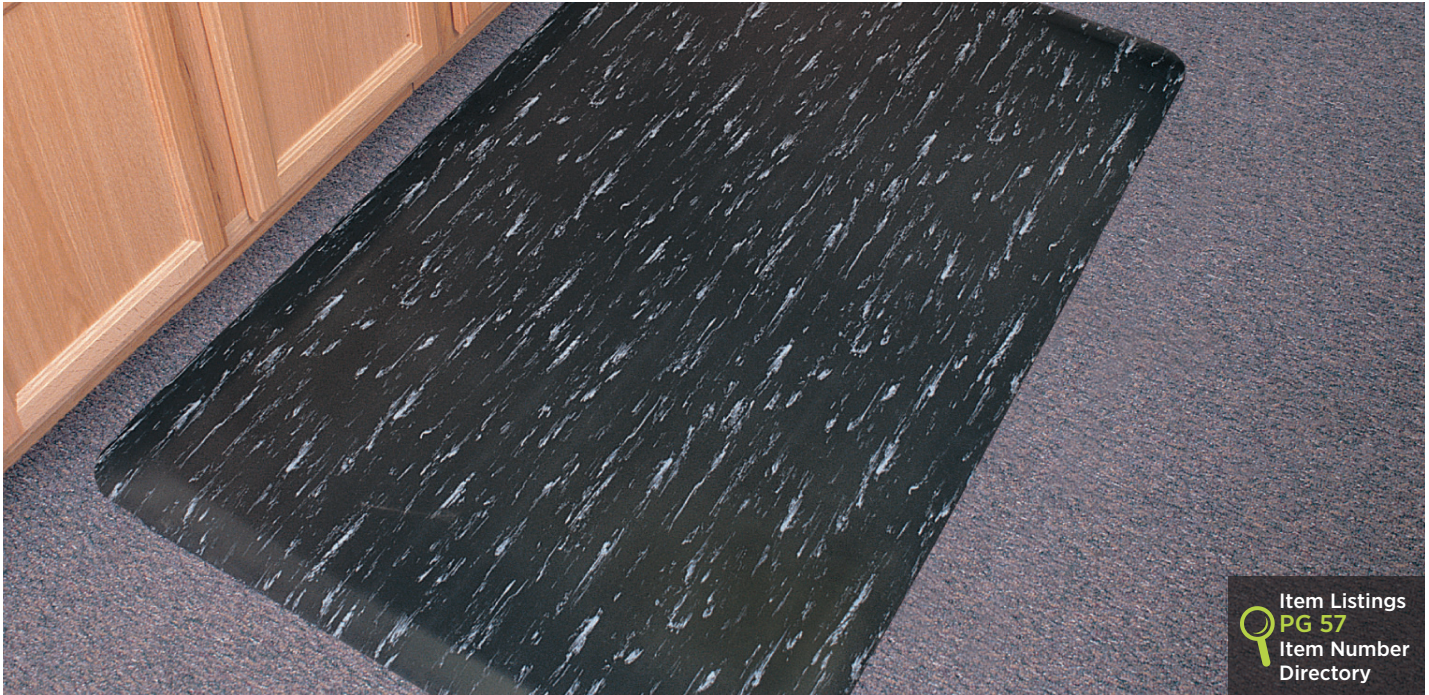

Item Listings
PG 57
Item Number
Directory

FEATURES & BENEFITS

1. 1/2" construction for additional comfort
2. Provides comfort for people who stand at counters and teller stations for long periods of time
3. Puncture resistance far exceeds comparable rubber products by up to 90%
4. Beveled edges
5. Easy to maintain - wipe off with a damp cloth or wash top surface with a mild soap

PLACEMENT

- Dry area assembly lines
- Light duty industrial areas
- Airports
- Customer service counters
- Hotel registration counters
- Hostess stations
- Salons
- Hospitals

SIZE

- 18"x30"
- 18"x48"
- 24"x36"
- 36"x60"

* Custom sizes are available in 2', 3', 4', 5' and 6' widths up to 60' long in 1' increments

COLORS

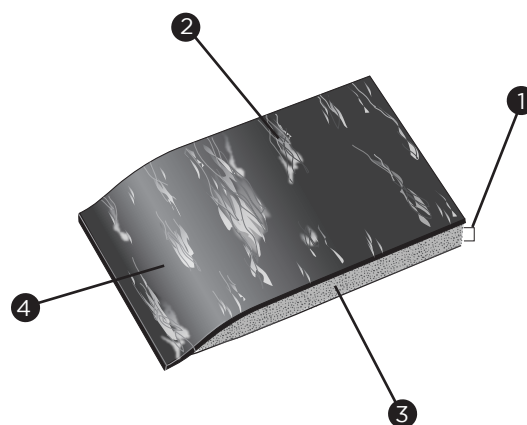
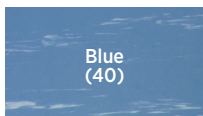
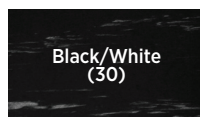
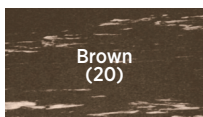



Item Listings
PG 57
Item Number
Directory

FEATURES & BENEFITS

1. 1/2" vinyl construction ensures higher durability and better resilience than ordinary vinyl sponge mats
2. Vinyl foam structure is both durable and economical
3. Puncture-resistant surface for maximum durability
4. Beveled edges help reduce the risk of slips, trips, and falls
5. Provides support for one's back, legs, and feet - helping to increase worker productivity
6. Easy maintenance - just wipes clean

PLACEMENT

- Customer service counters
- Register / check-out areas
- Airports
- Hotels
- Work stations
- Assembly lines
- Industrial areas
- Banks

SIZE

- 2'x3'
 - 3'x5'
 - 4'x6'
- * Custom sizes are available in 2', 3', 4', 5' and 6' widths up to 60' long in 1' increments

COLORS

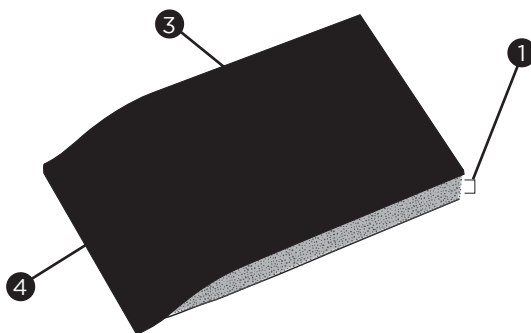
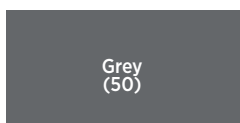
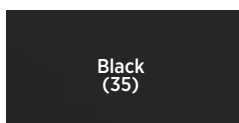

SOFT STEP/AIR STEP



FEATURES & BENEFITS

1. 3/8" vinyl construction ensures higher durability and better resilience than ordinary vinyl sponge mats
2. Support provided by vinyl foam structure
3. Reduces fatigue and discomfort
4. Can easily be cut to any custom size with just a pair of scissors

PLACEMENT

- Customer service counters
- Hotel registration desks
- Retail store check-out stands
- Building reception areas
- Work stations
- Restaurant hostess stations
- Industrial areas
- Assembly lines

SIZE

2'x3'	3'x12'
2'x60'	3'x60'
3'x5'	4'x60'
3'x10'	6'x60'

* Custom sizes are available in 2', 3', 4', 5' and 6' widths up to 60' long in 1' increments

SOFT STEP - TEXTURED SURFACE

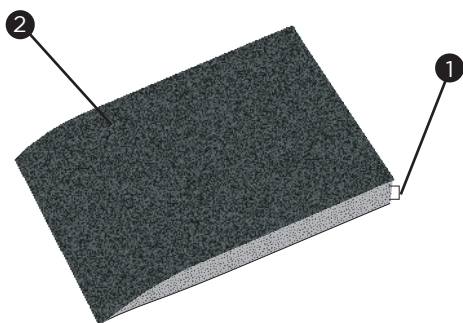

AIR STEP - RAISED RIDGE SURFACE

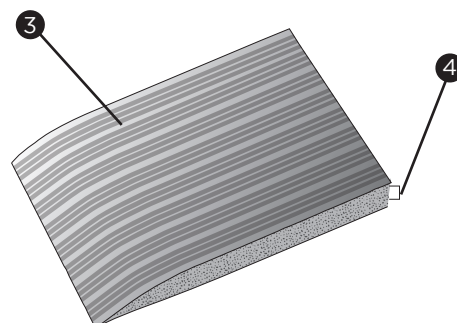

SOFT STEP SUPREME

NEW



FEATURES & BENEFITS

1. 1/2" vinyl construction ensures higher durability and better resilience than ordinary vinyl sponge mats
2. Support provided by vinyl foam structure
3. Reduces fatigue and discomfort
4. Constructed from a vinyl/nitrile blend for maximum comfort and resilience
5. Beveled edges allow for a smooth transition from floor to mat

PLACEMENT

- Customer service counters
- Hotel registration desks
- Retail store check-out stands
- Building reception areas
- Work stations
- Restaurant hostess stations
- Industrial areas
- Assembly lines

SIZE

2'x3'
3'x5'

PATTERNS

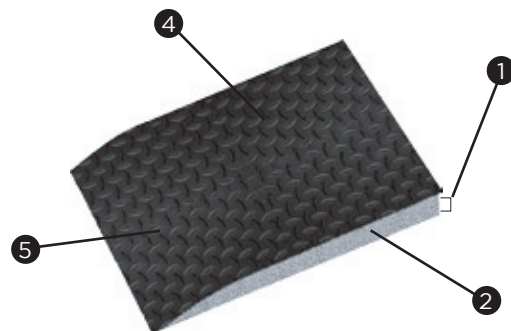
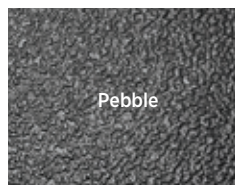
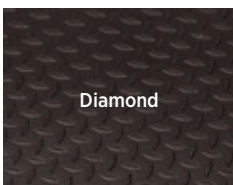



**PROVIDES BOTH
SAFETY AND
ANTI-FATIGUE
QUALITIES**

Item Listings
PG 58
Item Number
Directory

FEATURES & BENEFITS

1. 9/16" chemical-resistant material
2. Closed cell sponge base provides support to legs and back, reducing fatigue
3. Available without safety border
4. Durable vinyl surface resistant to most chemical spills
5. Non-flammable with beveled edges providing additional safety
6. Simply wipe surface or vacuum to clean
7. Safe step is self extinguishing when tested in accordance with FMVSS-302
8. Also available - Safe Step Supreme which features a 1" thickness for maximum comfort

PLACEMENT

- Dry, light duty industrial areas
- Airports
- Customer service counters
- Hotel registration counters
- Check-out counters
- Hostess stations

SIZE

- 2'x3'
- 3'x5'
- 3'x12'
- 3'x20'
- 4'x6'

* Custom sizes are available in 2', 3', 4', 5', and 6' widths up to 60' long in 1' increments

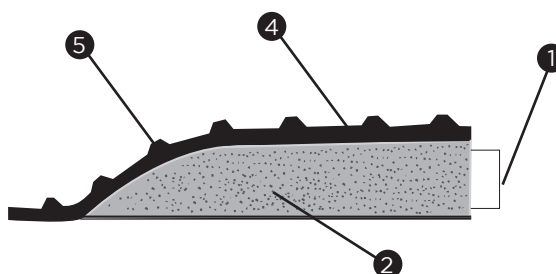



Item Listings
PG 58
Item Number
Directory

FEATURES & BENEFITS

1. 3/4" thickness and air domes provide comfort for legs, feet and back
2. Beveled edges increase safety by helping to prevent trips and falls
3. Helps to reduce fatigue and discomfort and helps to increase productivity
4. All-rubber construction for maximum durability
5. Received the APMA (American Podiatric Medical Association) Seal of Acceptance for promoting foot health
6. Certified 'High Traction' by the National Floor Safety Institute (NFSI)
7. Made from recycled rubber
8. Fully recyclable

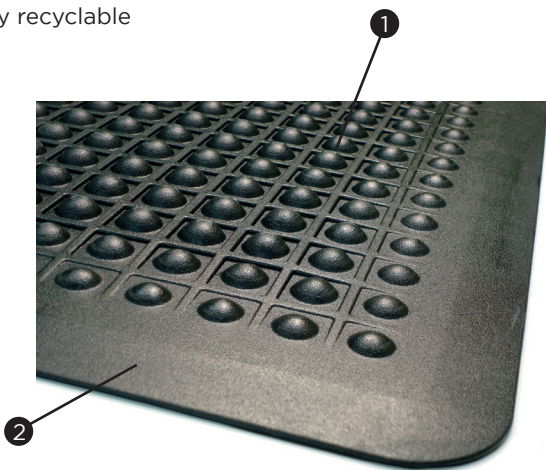

PLACEMENT

- Customer service counters
- Waiting areas
- Check-out counters
- Building reception counters
- Work stations
- Hostess stations
- Industrial areas

SIZE

2'x3'
3'x5'

*Listed sizes are approximate. Please see website for actual size.





Item Listings
PG 58
Item Number
Directory

FEATURES & BENEFITS

1. 5/8" construction for maximum durability and comfort
2. Vinyl-nitrile blend provides higher durability and better resilience
3. Anti-slip top is polymerically bonded to foam for added safety
4. Surface is chemically resistant to inorganic/organic acids, motor oil, and automotive greases
5. Provides support to knees and overall relief to those kneeling for prolonged periods of time
6. Top handle for easy carrying

PLACEMENT

- Industrial areas
- Assembly lines
- Work stations
- Maintenance areas
- Automotive repair shops

SIZE

14"x21"

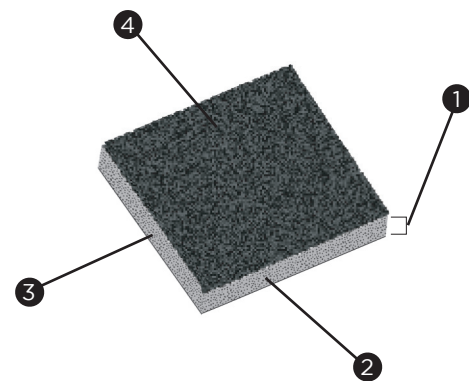

UTILITY/FOOD SERVICE MAT COLLECTION



MAT FACT

The food service industry requires unique solutions to floor protection. Guardian has created a line of mats specifically suited to these high intensity environments. With drainage holes for fluids and durable rubber construction, these mats can withstand the torture of even the most extreme food service environments.

FEATURING

Triple-Flex
Versa-lite
Free Flow Comfort
Safety Chef

TRIPLE-FLEX FLOW & SCRAPE



AVAILABLE
WITH OR
WITHOUT
DRAINAGE
HOLES

Item Listings
PG 59
Item Number
Directory

FEATURES & BENEFITS

1. Non-slip surface that is oil, water, and grease-resistant
2. Good for indoor and outdoor environments
3. Drainage holes allow liquids and dirt to pass through
4. Beveled and cleated edges help prevent slips, trips, and falls
5. Bacterial growth reduced by anti-microbial material
6. Offset backing provides additional softness and support
7. Easy-to-clean, durable, and lightweight all-rubber construction
8. Can be recycled
9. Triple-Flex Flow features drainage holes, while Triple-Flex Scrape has no holes (can also be used as an outdoor scraper)
10. Thickness: 1/4"

PLACEMENT

- Machine shops
- Work stations
- Gyms or fitness facilities
- Break rooms
- Bars
- Kitchens
- Water areas
- Restrooms

SIZE

- 2'x3'
- 3'x5'
- 3'x10'
- 4'x6'





**SUCTION CUP
BACKING FOR
MAXIMUM
STABILITY**

Item Listings
PG 59
Item Number
Directory

FEATURES & BENEFITS

1. Oil, water, and grease-resistant
2. Non-slip surface
3. Suction cup backing helps keep mat in place
4. Beveled and cleated edges help prevent slips, trips, and falls
5. Drainage holes allow liquids and dirt to pass through
6. Composed of anti-microbial material that reduces the growth of bacteria
7. Certified 'High Traction' by the National Floor Safety Institute (NFSI)
8. Commercial dishwasher safe
9. Can be recycled
10. Thickness: 1/2"

PLACEMENT

- Machine shops
- Work stations
- Gyms or fitness facilities
- Break rooms
- Bars
- Kitchens
- Water areas
- Restrooms

SIZE

3'x5' (31"x62")



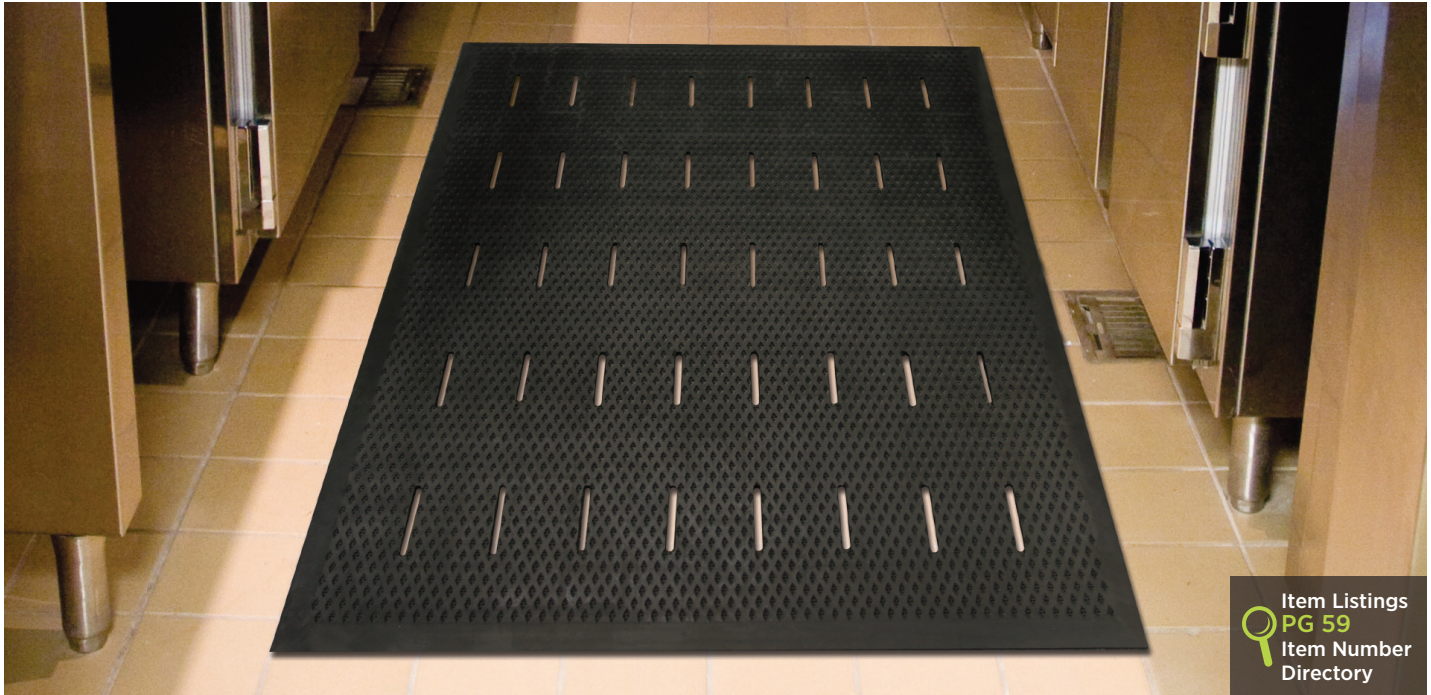

Item Listings
PG 59
Item Number
Directory

FEATURES & BENEFITS

1. 1/2" overall thickness increases comfort and productivity with its superior anti-fatigue properties
2. Drainage slots allow liquids to flow through the mat, keeping moisture away from feet
3. Raised cleats on top surface provides the mat with premium traction
4. Beveled edges help prevent slips, trips, and falls
5. Cross members on back reduce mat movement in wet or dry environments
6. Made from 100% rubber for long lasting maximum durability
7. Easy to clean - simply wipe with a damp cloth, sweep, vacuum or hose off

PLACEMENT

- Kitchens
- Water areas
- Bars
- Break rooms
- Machine shops
- Work stations
- Gyms or fitness
- Facilities
- Restrooms

SIZE

3'x4'

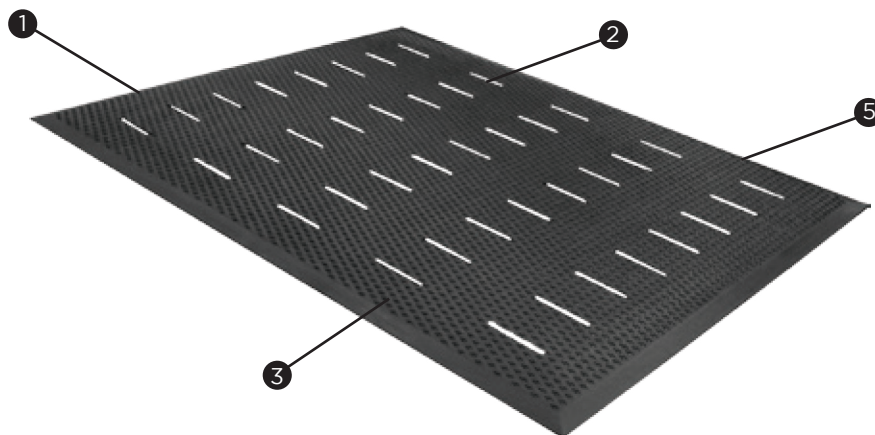

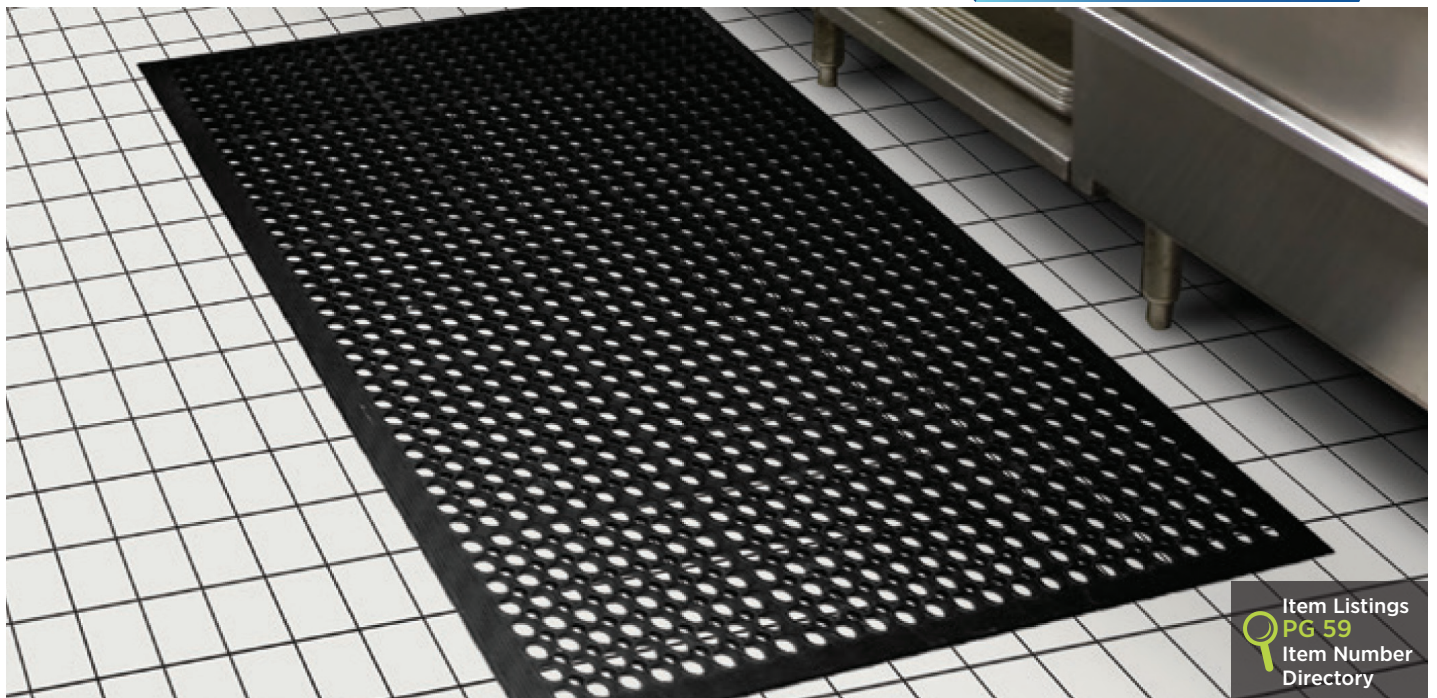

Item Listings
PG 59
Item Number
Directory

FEATURES & BENEFITS

1. Raised ridge design provides superior traction in wet or dry conditions
2. Grease-proof surface highly recommended for fry stations, cook lines, and greasy industrial stations
3. Provides anti-fatigue properties and comfort for workers
4. Beveled edges help prevent slips, trips, and falls
5. Drainage holes allow liquid and food to flow through the mat and away from the surface
6. Also available as 3'x3' linkable tiles that allow for customizable sizes
7. New Terracotta Red Grease Resistant
8. Thickness: 1/2"

PLACEMENT

- Food service
- Food processing and packaging
- Kitchens
- Bars
- Cafeterias
- Industrial work stations

SIZE

- * 3'x3' (linkable tiles)
- * 3'x5'

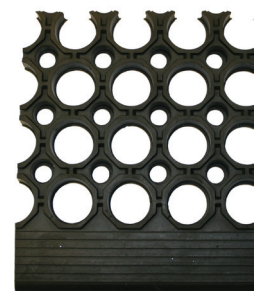
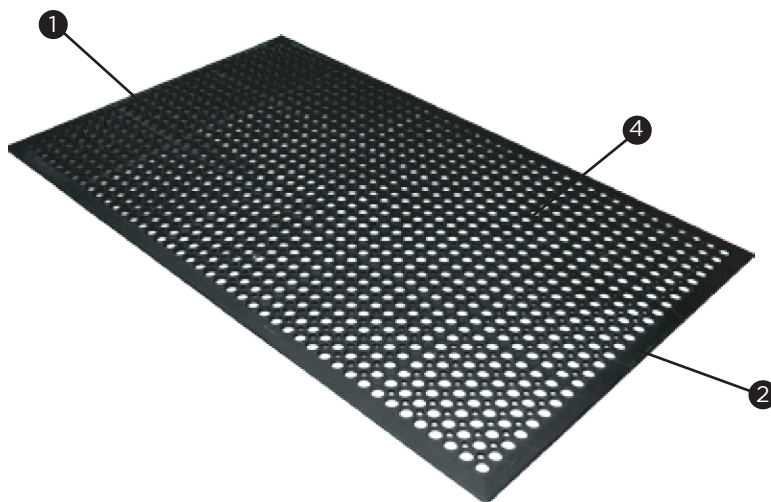

Black Safety Chef



Terracotta Safety Chef Red

ITEM NUMBER DIRECTORY



- Ordering Logo Mats
- Prestige Logo
- Clean Step Logo Scaper
- Media Mats
- Motif Mats
- UltraGuard Logo Inlay
- WaterGuard Logo Inlay
- Logo Impressions
- Printed Message Mats
- Photo Mats
- Outdoor Mat Collection
- Clean Step Scaper
- Parquet Wiper Scaper
- Brush Tip
- Indoor Mat Collection
- UltraGuard
- WaterGuard
- WaterGuard Diamond
- Platinum Series
- Golden Series
- Silver Series
- EcoGuard
- EcoGuard Diamond
- Anti-Fatigue Mat Collection
- Marble Top
- Pro To
- Safe Step
- Flex Step
- Soft Step/ Air Step
- Soft Step Supreme
- Kneel Relief
- Utility/ Food Service
- Mat Collection
- Triple-Flex Flow & Scrape
- Versa-Lite
- Free Flow/ Comfort
- Safety Chef

LOGO & MESSAGE MAT COLLECTION

PRESTIGE CUSTOM LOGO MATS WITH NITRILE (RUBBER) BACKING

Size	Weight	List
2'x3'	3	\$86.02
2'x4'	4	\$104.36
2'x5'	5	\$130.44
2'x6'	6	\$156.53
2'x7'	7	\$182.62
2'x8'	8	\$208.71
2'x9'	9	\$234.80
2'x10'	10	\$260.89
2'x11'	11	\$286.96
2'x12'	12	\$313.04
2'x13'	13	\$339.13
2'x14'	14	\$365.22
2'x15'	15	\$391.31
2'x16'	16	\$417.90
2'x17'	17	\$443.49
2'x18'	18	\$469.58
2'x19'	19	\$495.67
2'x20'	20	\$521.76
3'x3'	4.5	\$117.40
3'x4'	6	\$156.53
3'x5'	7.5	\$230.51
3'x6'	9	\$234.80
3'x7'	10.5	\$273.91
3'x8'	12	\$313.04
3'x9'	13.5	\$352.18
3'x10'	15	\$391.31
3'x11'	16.5	\$430.44
3'x12'	18	\$469.58
3'x13'	19.5	\$508.71
3'x14'	21	\$547.84
3'x15'	22.5	\$586.98
3'x16'	24	\$626.11
3'x17'	25.5	\$665.24
3'x18'	27	\$695.53
3'x19'	28.5	\$743.51
3'x20'	30	\$782.64
4'x4'	8	\$208.71
4'x5'	10	\$260.89
4'x6'	12	\$313.22
4'x7'	14	\$365.22
4'x8'	16	\$417.40
4'x9'	18	\$468.58
4'x10'	20	\$480.89
4'x11'	22	\$528.98
4'x12'	24	\$577.07
4'x13'	26	\$625.16
4'x14'	28	\$673.24
4'x15'	30	\$721.31
4'x16'	32	\$769.40
4'x17'	34	\$817.49
4'x18'	36	\$865.58
4'x19'	38	\$913.67
4'x20'	40	\$961.76
5'x5'	12.5	\$300.56
5'x6'	15	\$360.67

5'x7'	17.5	\$420.78
5'x8'	20	\$480.89
5'x9'	22.5	\$541.00
5'x10'	25	\$601.11
5'x11'	27.5	\$661.22
5'x12'	30	\$721.31
5'x13'	32.5	\$781.42
5'x14'	35	\$841.56
5'x15'	37.5	\$901.67
5'x16'	40	\$961.76
5'x17'	42.5	\$1021.87
5'x18'	45	\$1081.98
5'x19'	47.5	\$1142.11
5'x20'	50	\$1202.20
6'x6'	18	\$432.80
6'x7'	21	\$504.93
6'x8'	24	\$577.07
6'x9'	27	\$649.20
6'x10'	30	\$721.31
6'x11'	33	\$793.44
6'x12'	36	\$865.58
6'x13'	39	\$937.71
6'x14'	42	\$1009.84
6'x15'	45	\$1081.98
6'x16'	48	\$1154.11
6'x17'	51	\$1226.24
6'x18'	54	\$1298.38
6'x19'	57	\$1370.51
6'x20'	60	\$1442.64

Call factory for vinyl backing pricing.

COLORS



LOGO & MESSAGE MAT COLLECTION

WATERGUARD LOGO INLAY

MLL Item #	Description	Size	Weight	List
WGL020302	WaterGuard Inlay 2'x3'	2'x3'	3	\$233.51
WGL030402	WaterGuard Inlay 3'x4'	3'x4'	6	\$361.64
WGL030502	WaterGuard Inlay 3'x5'	3'x5'	7.5	\$403.07
WGL030802	WaterGuard Inlay 3'x8'	3'x8'	12	\$675.42
WGL031002	WaterGuard Inlay 3'x10'	3'x10'	15	\$791.89
WGL031202	WaterGuard Inlay 3'x12'	3'x12'	18	\$1155.42
WGL031602	WaterGuard Inlay 3'x16'	3'x16'	24	\$1363.87
WGL032002	WaterGuard Inlay 3'x20'	3'x20'	30	\$1535.96
WGL040602	WaterGuard Inlay 4'x6'	4'x6'	12	\$573.53
WGL040802	WaterGuard Inlay 4'x8'	4'x8'	16	\$711.36
WGL041002	WaterGuard Inlay 4'x10'	4'x10'	20	\$887.36
WGL041202	WaterGuard Inlay 4'x12'	4'x12'	24	\$1088.71
WGL041602	WaterGuard Inlay 4'x16'	4'x16'	32	\$1478.33
WGL042002	WaterGuard Inlay 4'x20'	4'x20'	40	\$1741.22
WGL060802	WaterGuard Inlay 6'x8'	6'x8'	24	\$1043.02
WGL061202	WaterGuard Inlay 6'x12'	6'x12'	36	\$1500.60
WGL061602	WaterGuard Inlay 6'x16'	6'x16'	48	\$1961.53
WGL062002	WaterGuard Inlay 6'x20'	6'x20'	60	\$2337.84

MESSAGE MATS

MLL Item #	Description	Size	Weight	List
MLL-07302236	ABC Childcare/Preschool	3'x5'	8	\$147.73
91005840	Alphabet Faces	3'x5'	8	\$147.73
91005833	Numbers - English and Spanish	3'x5'	8	\$147.73
91005869	Animal Wagon - Green	3'x5'	8	\$147.73
91005997	Read Books	3'x5'	8	\$147.73
91005843	City Streets	3'x5'	8	\$147.73
91005836	Hopscotch	3'x5'	8	\$147.73
MLL-44030531	Target Safety Mat	3'x5'	8	\$147.73
MLL-00002725	Time For Safety	3'x5'	8	\$147.73
MLL-00002723	Safety Extinguisher	3'x5'	8	\$147.73
MLL-00002724	Safety Hardhat	3'x5'	8	\$147.73
MLL-44030541	Quality Ribbon Mat	3'x5'	8	\$147.73
MLL-00002728	Quality Thumbs Up	3'x5'	8	\$147.73
MLL-00002729	Quality Blocks	3'x5'	8	\$147.73
MLL-00002730	Quality Cards	3'x5'	8	\$147.73
91004459	Safety All Areas	3'x5'	8	\$147.73
91004461	Safety Eagle	3'x5'	8	\$147.73
91004462	Safety Hardhat	3'x5'	8	\$147.73
91004463	Safety Clock	3'x5'	8	\$147.73
91000131	Think Safe	3'x5'	8	\$147.73
91000128	Safety Chances	3'x5'	8	\$147.73
91000179	Sure Winner	3'x5'	8	\$147.73
91000346	Target Safety	3'x5'	8	\$147.73
91000347	Time For Safety	3'x5'	8	\$147.73
MLL-44030561	Coffee Mug Mat	3'x5'	8	\$147.73
91008494	Ice	3'x5'	8	\$147.73
MLL-00013173	Water Cooler Blue	2'x3'	4	\$45.64
MLL-00013177	Water Cooler Grey	2'x3'	4	\$45.64
MLL-00013175	Water Splash Black	2'x3'	4	\$45.64

LOGO & MESSAGE MAT COLLECTION

MESSAGE MATS (CONTINUED)

MLL Item #	Description	Size	weight	List
MLL-00013176	Water Splash Grey	2'x3'	4	\$45.64
MLL-00003783	Anti-Drug Honesty	3'x5'	8	\$147.73
MLL-00003785	Anti-Drug Honesty	4'x6'	12	\$255.02
MLL-00003786	Anti-Drug Communication	3'x5'	8	\$147.73
MLL-00003788	Anti-Drug Communication	4'x6'	12	\$255.02
MLL-00003789	Anti-Drug Trust	3'x5'	8	\$147.73
MLL-00003791	Anti-Drug Trust	4'x6'	12	\$255.02
MLL-00003792	Anti-Drug Truth	3'x5'	8	\$147.73
MLL-00003794	Anti-Drug Truth	4'x6'	12	\$255.02
MLL-00003795	Anti-Drug Music	3'x5'	8	\$147.73
MLL-00003797	Anti-Drug Music	4'x6'	12	\$255.02
MLL-00003798	Anti-Drug Sports	3'x5'	8	\$147.73
MLL-00003800	Anti-Drug Sports	4'x6'	12	\$255.02
MLL-00003801	Anti-Drug Art	3'x5'	8	\$147.73
MLL-00003803	Anti-Drug Art	4'x6'	12	\$255.02
MLL-00003804	Anti-Drug Education	3'x5'	8	\$147.73
MLL-00003806	Anti-Drug Education	4'x6'	12	\$255.02
MLL-91008501	Bakery	3'x10'	15	\$318.67
MLL-91008505	Pizza	3'x10'	15	\$318.67
MLL-91008502	Deli	3'x10'	15	\$318.67
MLL-91008504	Fresh Produce	3'x10'	15	\$318.67
91008727	Motivational Golf	3'x5'	8	\$147.73
91008728	Motivational Bridge	3'x5'	8	\$147.73
91008729	Motivational Pyramids	3'x5'	8	\$147.73
91008730	Motivational Flower	3'x5'	8	\$147.73

DESIGNS

DAYCARE MATS 3'X 5'



DAYCARE MATS 3'X 5'

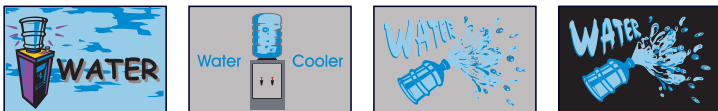

ANTI-DRUG MATS 3'X 5' AND 4'X 6'



SAFETY MATS 3'X 5'



LOGO & MESSAGE MAT COLLECTION

MOTIVATIONAL MATS 3'X 5'



GROCERY MATS 3'X10'



SAFETY AND QUALITY MATS 3'X 5'

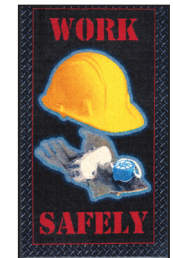
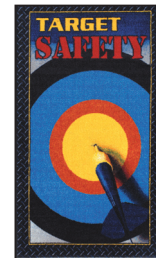
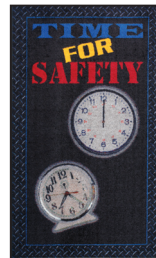
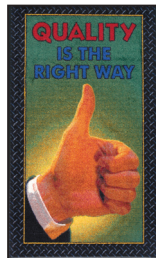
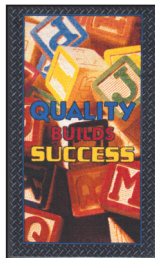

CLEAN STEP LOGO SCRAPER

Description	Weight	qty 1	qty 2-10	qty 11-25	qty 26 +
Logo Scraper 2'x3'	6	\$93.38	\$80.02	\$70.04	\$62.27
Logo Scraper 3'x5'	17	\$195.67	\$147.00	\$130.09	\$124.96
Logo Scraper 3'x10'	34.5	\$446.22	\$382.47	\$334.677	\$297.49
Logo Scraper 4'x6'	25	\$247.11	\$196.53	\$187.44	\$185.60
Logo Scraper 6'x6'	37	\$500.00	\$477.78	\$422.22	\$377.78
Logo Scraper 6'x8'	49	\$666.67	\$637.78	\$555.56	\$500.00

OUTDOOR MAT COLLECTION

CLEAN STEP SCRAPER

MLL Item #	Description	Size	Weight	Color	List
14020300	Clean Step	2'x3'	6	Black	\$30.67
14030500	Clean Step	3'x5'	17	Black	\$76.00
14031000	Clean Step	3'x10'	34.5	Black	\$152.00
14040600	Clean Step	4'x6'	25	Black	\$121.60

PARQUET WIPER SCRAPER

MLL Item #	Description	Size	Weight	Color	List
PARQUET2X3	Parquet Wiper	2'x3'	5	Black	\$40.67
PARQUET3X5	Parquet Wiper	3'x5'	10	Black	\$101.67

BRUSH TIP

MLL Item #	Description	Size	Weight	Color	List
14243205	Brush Tip	24"X32"	13	Black	\$18.51
14030605	Brush Tip	36"X72"	39	Black	\$75.56
14030305	Brush Tip	32"X39"	19	Black	\$98.40

INDOOR MAT COLLECTION

ELITEGUARD

MLL Item #	Description	Size	Weight	List
UG0305XX	EliteGuard 3'x5'	3'x5'	8	\$141.67
UG0310XX	EliteGuard 3'x10'	3'x10'	15	\$283.33
UG0406XX	EliteGuard 4'x6'	4'x6'	12	\$226.67
UG0408XX	EliteGuard 4'x8'	4'x8'	16	\$302.22
UG0410XX	EliteGuard 4'x10'	4'x10'	20	\$377.78
UG0608XX	EliteGuard 6'x8'	6'x8'	24	\$453.33
UG0610XX	EliteGuard 6'x10'	6'x10'	30	\$566.67
UG0612XX	EliteGuard 6'x12'	6'x12'	36	\$680.00

* For EliteGuard only, XX = full name of color (i.e. UG0305CHARCOAL)

WATERGUARD

MLL Item #	Description	Size	Weight	List	Colors
WG0203XX	WaterGuard	2'x3'	3	\$33.60	Blue (02) Charcoal (04) Burgundy (06) Green (08) Grey (10) Red (12) Brown (14) Navy (18)
WG0304XX	WaterGuard	3'x4'	6	\$67.20	
WG0305XX	WaterGuard	3'x5'	7.5	\$84.00	
WG0310XX	WaterGuard	3'x10'	15	\$168.00	
WG0312XX	WaterGuard	3'x12'	18	\$201.60	
WG0320XX	WaterGuard	3'x20'	30	\$336.00	
WG0406XX	WaterGuard	4'x6'	12	\$134.40	
WG0408XX	WaterGuard	4'x8'	16	\$179.20	
WG0410XX	WaterGuard	4'x10'	20	\$224.00	
WG0412XX	WaterGuard	4'x12'	24	\$268.80	
WG0420XX	WaterGuard	4'x20'	40	\$448.00	
WG0608XX	WaterGuard	6'x8'	24	\$268.80	

WATERGUARD DIAMOND

MLL Item #	Description	Size	Weight	List	Colors
WGDFB0305XX	WaterGuard Diamond Fabric Border	3'x5'	7.5	\$93.67	Blue (02) Charcoal (04) Burgundy (06) Green (08) Grey (10) Red (12) Brown (14) Navy (18)
WGDRB0305XX	WaterGuard Diamond Rubber Border	3'x5'	7.5	\$93.67	
WGDFB0308XX	WaterGuard Diamond Fabric Border	3'x8'	12	\$149.87	
WGDRB0308XX	WaterGuard Diamond Rubber Border	3'x8'	12	\$149.87	
WGDFB0310XX	WaterGuard Diamond Fabric Border	3'x10'	15	\$187.33	
WGDRB0310XX	WaterGuard Diamond Rubber Border	3'x10'	15	\$187.33	
WGDFB0312XX	WaterGuard Diamond Fabric Border	3'x12'	18	\$224.80	
WGDRB0312XX	WaterGuard Diamond Rubber Border	3'x12'	18	\$224.80	
WGDFB0314XX	WaterGuard Diamond Fabric Border	3'x14'	21	\$262.27	
WGDRB0314XX	WaterGuard Diamond Rubber Border	3'x14'	21	\$262.27	
WGDFB0316XX	WaterGuard Diamond Fabric Border	3'x16'	24	\$299.73	
WGDRB0316XX	WaterGuard Diamond Rubber Border	3'x16'	24	\$299.73	
WGDFB0320XX	WaterGuard Diamond Fabric Border	3'x20'	30	\$374.67	
WGDRB0320XX	WaterGuard Diamond Rubber Border	3'x20'	30	\$374.67	
WGDFB0406XX	WaterGuard Diamond Fabric Border	4'x6'	12	\$149.87	
WGDRB0406XX	WaterGuard Diamond Rubber Border	4'x6'	12	\$149.87	
WGDFB0408XX	WaterGuard Diamond Fabric Border	4'x8'	16	\$199.82	
WGDRB0408XX	WaterGuard Diamond Rubber Border	4'x8'	16	\$199.82	
WGDFB0410XX	WaterGuard Diamond Fabric Border	4'x10'	20	\$249.78	
WGDRB0410XX	WaterGuard Diamond Rubber Border	4'x10'	20	\$249.78	
WGDFB0412XX	WaterGuard Diamond Fabric Border	4'x12'	24	\$299.73	
WGDRB0412XX	WaterGuard Diamond Rubber Border	4'x12'	24	\$299.73	
WGDFB0416XX	WaterGuard Diamond Fabric Border	4'x16'	32	\$399.64	
WGDRB0416XX	WaterGuard Diamond Rubber Border	4'x16'	32	\$399.64	

INDOOR MAT COLLECTION

WATERGUARD DIAMOND (CONTINUED)

MLL Item #	Description	Size	Weight	List
WGDFB0420XX	WaterGuard Diamond Fabric Border	4'x20'	40	\$499.56
WGDRB0420XX	WaterGuard Diamond Rubber Border	4'x20'	40	\$499.56
WGDFB0608XX	WaterGuard Diamond Fabric Border	6'x8'	24	\$299.73
WGDRB0608XX	WaterGuard Diamond Rubber Border	6'x8'	24	\$299.73
WGDFB0610XX	WaterGuard Diamond Fabric Border	6'x10'	30	\$374.67
WGDRB0610XX	WaterGuard Diamond Rubber Border	6'x10'	30	\$374.67
WGDFB0612XX	WaterGuard Diamond Fabric Border	6'x12'	36	\$449.60
WGDRB0612XX	WaterGuard Diamond Rubber Border	6'x12'	36	\$449.60
WGDFB0616XX	WaterGuard Diamond Fabric Border	6'x16'	48	\$599.47
WGDRB0616XX	WaterGuard Diamond Rubber Border	6'x16'	48	\$599.47
WGDFB0620XX	WaterGuard Diamond Fabric Border	6'x20'	60	\$744.33
WGDRB0620XX	WaterGuard Diamond Rubber Border	6'x20'	60	\$744.33

MLL Item #	Description	Size	Weight	List
WGDSF0306XX	WaterGuard Diamond Single Fan	3'x6'	12.6	\$112.40
WGDSF0310XX	WaterGuard Diamond Single Fan	3'x10'	21	\$187.33
WGDSF0314XX	WaterGuard Diamond Single Fan	3'x14'	29.4	\$262.27
WGDSF0318XX	WaterGuard Diamond Single Fan	3'x18'	37.8	\$337.20
WGDSF0320XX	WaterGuard Diamond Single Fan	3'x20'	42	\$374.67
WGDSF0408XX	WaterGuard Diamond Single Fan	4'x8'	22.4	\$199.82
WGDSF0410XX	WaterGuard Diamond Single Fan	4'x10'	28	\$249.78
WGDSF0414XX	WaterGuard Diamond Single Fan	4'x14'	39.2	\$349.69
WGDSF0418XX	WaterGuard Diamond Single Fan	4'x18'	50.4	\$449.60
WGDSF0420XX	WaterGuard Diamond Single Fan	4'x20'	56	\$499.56
WGDSF0611XX	WaterGuard Diamond Single Fan	6'x11'	46.2	\$410.67
WGDSF0615XX	WaterGuard Diamond Single Fan	6'x15'	63	\$562.00
WGDSF061902	WaterGuard Diamond Single Fan	6'x19'	79.8	\$711.87

MLL Item #	Description	Size	Weight	List
WGDDF0308XX	WaterGuard Diamond Double Fan	3'x8'	16.8	\$149.87
WGDDF0312XX	WaterGuard Diamond Double Fan	3'x12'	25.2	\$224.80
WGDDF0316XX	WaterGuard Diamond Double Fan	3'x16'	33.6	\$299.73
WGDDF0320XX	WaterGuard Diamond Double Fan	3'x20'	42	\$374.67
WGDDF0408XX	WaterGuard Diamond Double Fan	4'x8'	22.4	\$199.82
WGDDF0412XX	WaterGuard Diamond Double Fan	4'x12'	33.6	\$299.73
WGDDF0416XX	WaterGuard Diamond Double Fan	4'x16'	44.8	\$399.64
WGDDF0420XX	WaterGuard Diamond Double Fan	4'x20'	56	\$499.56
WGDDF0614XX	WaterGuard Diamond Double Fan	6'x14'	58.8	\$524.53
WGDDF0616XX	WaterGuard Diamond Double Fan	6'x16'	67.2	\$599.47
WGDDF0618XX	WaterGuard Diamond Double Fan	6'x18'	75.6	\$674.40
WGDDF0621XX	WaterGuard Diamond Double Fan	6'x21'	88.2	\$786.80

MLL Item #	Description	Size	Weight	List
WGDFAN0203XX	WaterGuard Diamond 3' Fan	2'x3'	4.2	\$34.47
WGDFAN0204XX	WaterGuard Diamond 4' Fan	2'x4'	5.6	\$49.96
WGDFAN0306XX	WaterGuard Diamond 6' Fan	3'x6'	12.6	\$112.89

INDOOR MAT COLLECTION

DIAMOND SERIES

MLL Item #	Description	Size	Weight	List
64020365DS	Diamond Scraper/Walk-off	2' X 3'	4	\$40.67
64030465DS	Diamond Scraper/Walk-off	3' X 4'	10	\$81.33
64030365DS	Diamond Scraper/Walk-off	3' X 5'	20	\$101.67
64031065DS	Diamond Scraper/Walk-off	3' X 10'	16	\$203.33
64020365DS	Diamond Scraper/Walk-off	3' X 60'	8	\$1,220.00
64040665DS	Diamond Scraper/Walk-off	4' X 6'	11	\$162.67
64040865DS	Diamond Scraper/Walk-off	4' X 8'	13	\$216.89
64041065DS	Diamond Scraper/Walk-off	4' X 10'	32	\$271.11
64046065DS	Diamond Scraper/Walk-off	4' X 60'	175	\$1,626.67
64060865DS	Diamond Scraper/Walk-off	6' X 8'	268	\$325.33
64062065DS	Diamond Scraper/Walk-off	6' X 20'	355	\$813.33
64066065DS	Diamond Scraper/Walk-off	6' X 60'	355	\$2,440.00

PLATINUM SERIES

MLL Item #	Description	Size	Weight	List	Colors
940203XX	Platinum Series - Solution Dyed Nylon / Rubber	2'x3'	4	\$31.47	Red (15)
940304XX	Platinum Series - Solution Dyed Nylon / Rubber	3'x4'	7	\$62.93	Blue (20)
940305XX	Platinum Series - Solution Dyed Nylon / Rubber	3'x5'	8.5	\$78.67	Grey (30)
940310XX	Platinum Series - Solution Dyed Nylon / Rubber	3'x10'	16	\$157.33	Black (35)
940406XX	Platinum Series - Solution Dyed Nylon / Rubber	4'x6'	13	\$125.87	Green (40)
940408XX	Platinum Series - Solution Dyed Nylon / Rubber	4'x8'	17	\$167.82	Brown (50)
940410XX	Platinum Series - Solution Dyed Nylon / Rubber	4'x10'	21	\$209.78	Burgundy (55)
940412XX	Platinum Series - Solution Dyed Nylon / Rubber	4'x12'	25	\$251.73	Brick (80)
					Black Mink (28)
					Black Steel (33)
					Midnight (78)

GOLDEN SERIES DUAL-RIB

MLL Item #	Description	Size	Weight	List	Colors
640203XX	Golden Series Dual-Rib Vinyl Backed	2'x3'	3	\$21.47	Chocolate (20)
640304XX	Golden Series Dual-Rib Vinyl Backed	3'x4'	6	\$42.93	Blue (25)
640305XX	Golden Series Dual-Rib Vinyl Backed	3'x5'	7.5	\$53.67	Charcoal (30)
640306XX	Golden Series Dual-Rib Vinyl Backed	3'x6'	9	\$64.40	Red (35)
640310XX	Golden Series Dual-Rib Vinyl Backed	3'x10'	15	\$107.33	Beige (40)
640360XX	Golden Series Dual-Rib Vinyl Backed	3'x60'	90	\$644.00	Green (45)
640406XX	Golden Series Dual-Rib Vinyl Backed	4'x6'	12	\$85.87	Grey (50)
640408XX	Golden Series Dual-Rib Vinyl Backed	4'x8'	16	\$114.49	
640410XX	Golden Series Dual-Rib Vinyl Backed	4'x10'	20	\$143.11	
640460XX	Golden Series Dual-Rib Vinyl Backed	4'x60'	120	\$858.67	
640660XX	Golden Series Dual-Rib Vinyl Backed	6'x60'	180	\$1288.00	

GOLDEN SERIES CHEVRON

MLL Item #	Description	Size	Weight	List	Colors
640203XXCHEV	Golden Series Chevron Vinyl Backed	2'x3'	3	\$21.47	Chocolate (20)
640304XXCHEV	Golden Series Chevron Vinyl Backed	3'x4'	6	\$42.93	Blue (25)
640305XXCHEV	Golden Series Chevron Vinyl Backed	3'x5'	7.5	\$53.67	Charcoal (30)
640306XXCHEV	Golden Series Chevron Vinyl Backed	3'x6'	9	\$64.40	Red (35)
640310XXCHEV	Golden Series Chevron Vinyl Backed	3'x10'	15	\$107.33	Green (45)
640360XXCHEV	Golden Series Chevron Vinyl Backed	3'x60'	90	\$644.00	
640406XXCHEV	Golden Series Chevron Vinyl Backed	4'x6'	12	\$85.87	
610408XXCHEV	Golden Series Chevron Vinyl Backed	4'x8'	16	\$114.49	
640410XXCHEV	Golden Series Chevron Vinyl Backed	4'x10'	20	\$143.11	
640460XXCHEV	Golden Series Chevron Vinyl Backed	4'x60'	120	\$858.67	
640660XXCHEV	Golden Series Chevron Vinyl Backed	6'x60'	180	\$1288.00	

INDOOR MAT COLLECTION

GOLDEN SERIES HOBNAIL

MLL Item #	Description	Size	Weight	List	Colors
640203XXHOB	Golden Series Hobnail Vinyl Backed	2'x3'	3	\$21.47	Charcoal (30) Green (45) Grey (50) Maroon (55) Sand (60)
640304XXHOB	Golden Series Hobnail Vinyl Backed	3'x4'	6	\$42.93	
640305XXHOB	Golden Series Hobnail Vinyl Backed	3'x5'	7.5	\$53.67	
640306XXHOB	Golden Series Hobnail Vinyl Backed	3'x6'	9	\$64.40	
640310XXHOB	Golden Series Hobnail Vinyl Backed	3'x10'	15	\$107.33	
640360XXHOB	Golden Series Hobnail Vinyl Backed	3'x60'	90	\$644.00	
640406XXHOB	Golden Series Hobnail Vinyl Backed	4'x6'	12	\$85.87	
640408XXHOB	Golden Series Hobnail Vinyl Backed	4'x8'	16	\$114.49	
640410XXHOB	Golden Series Hobnail Vinyl Backed	4'x10'	20	\$143.11	
640460XXHOB	Golden Series Hobnail Vinyl Backed	4'x60'	120	\$858.67	
640660XXHOB	Golden Series Hobnail Vinyl Backed	6'x60'	180	\$1288.00	

GOLDEN SERIES WOVEN

MLL Item #	Description	Size	Weight	List	Colors
640203XXWOV	Golden Series Woven Vinyl Backed	2'x3'	3	\$21.47	Black (10) Navy (25) Charcoal (30) Beige (40) Grey (50) Green (45)
640304XXWOV	Golden Series Woven Vinyl Backed	3'x4'	6	\$42.93	
640305XXWOV	Golden Series Woven Vinyl Backed	3'x5'	7.5	\$53.67	
640306XXWOV	Golden Series Woven Vinyl Backed	3'x6'	9	\$64.40	
640310XXWOV	Golden Series Woven Vinyl Backed	3'x10'	15	\$107.33	
640360XXWOV	Golden Series Woven Vinyl Backed	3'x60'	90	\$644.00	
640406XXWOV	Golden Series Woven Vinyl Backed	4'x6'	12	\$85.87	
640408XXWOV	Golden Series Woven Vinyl Backed	4'x8'	16	\$114.49	
640410XXWOV	Golden Series Woven Vinyl Backed	4'x10'	20	\$143.11	
640460XXWOV	Golden Series Woven Vinyl Backed	4'x60'	120	\$858.67	
640660XXWOV	Golden Series Woven Vinyl Backed	6'x60'	180	\$1288.00	

SILVER SERIES OLEFIN

MLL Item #	Description	Size	Weight	List	Colors
740203XX	Silver Series Olefin Vinyl Backed	2'x3'	4.5	\$21.47	Red/Black (15) Sable (20) Charcoal (30) Speckled Blue (40) Green (45) Walnut (50) Black (35)
740304XX	Silver Series Olefin Vinyl Backed	3'x4'	9	\$42.93	
740305XX	Silver Series Olefin Vinyl Backed	3'x5'	11.25	\$53.67	
740306XX	Silver Series Olefin Vinyl Backed	3'x6'	13.5	\$64.40	
740310XX	Silver Series Olefin Vinyl Backed	3'x10'	22.5	\$107.33	
740360XX	Silver Series Olefin Vinyl Backed	3'x60'	135	\$644.00	
740406XX	Silver Series Olefin Vinyl Backed	4'x6'	18	\$85.87	
740408XX	Silver Series Olefin Vinyl Backed	4'x8'	24	\$114.49	
740410XX	Silver Series Olefin Vinyl Backed	4'x10'	30	\$143.11	
740460XX	Silver Series Olefin Vinyl Backed	4'x60'	180	\$858.67	
740660XX	Silver Series Olefin Vinyl Backed	6'x60'	270	\$1288.00	

ECOGUARD

MLL Item #	Description	Size	Weight	List	Colors
EG0203XX	EcoGuard Fabric Border	2'x3'	4	\$30.13	Charcoal (04) Green (08) Blue (02) Brown (14)
EG0304XX	EcoGuard Fabric Border	3'x4'	8	\$60.27	
EG0305XX	EcoGuard Fabric Border	3'x5'	10	\$75.33	
EG0310XX	EcoGuard Fabric Border	3'x10'	20	\$150.67	
EG0406XX	EcoGuard Fabric Border	4'x6'	16	\$120.53	
EG0408XX	EcoGuard Fabric Border	4'x8'	11	\$160.71	
EG0410XX	EcoGuard Fabric Border	4'x10'	13	\$200.89	

INDOOR MAT COLLECTION

ECOGUARD DIAMOND

MLL Item #	Description	Size	Weight	List	Colors
EGDFB0203XX	EcoGuard Diamond Fabric Border	2'x3'	4	\$30.13	Charcoal (04) Green (08) Blue (02) Brown (14)
EGDFB0304XX	EcoGuard Diamond Fabric Border	3'x4'	8	\$60.27	
EGDFB0305XX	EcoGuard Diamond Fabric Border	3'x5'	10	\$75.33	
EGDFB0310XX	EcoGuard Diamond Fabric Border	3'x10'	20	\$150.67	
EGDFB0406XX	EcoGuard Diamond Fabric Border	4'x6'	16	\$120.53	
EGDFB0408XX	EcoGuard Diamond Fabric Border	4'x8'	11	\$160.71	
EGDFB0410XX	EcoGuard Diamond Fabric Border	4'x10'	13	\$200.89	

MLL Item #	Description	Size	Weight	List	Colors
EGDSF0306XX	EcoGuard Diamond Single Fan	3' X 6'	12	\$90.40	Black (10) Charcoal (04) Green (08) Blue (02) Brown (14)
EGDSF0310XX	EcoGuard Diamond Single Fan	3' X 10'	20	\$150.67	
EGDSF0314XX	EcoGuard Diamond Single Fan	3' X 14'	28	\$210.93	
EGDSF0318XX	EcoGuard Diamond Single Fan	3' X 18'	36	\$271.20	
EGDSF0320XX	EcoGuard Diamond Single Fan	3' X 20'	40	\$301.33	
EGDSF0408XX	EcoGuard Diamond Single Fan	4' X 8'	22	\$160.71	
EGDSF0410XX	EcoGuard Diamond Single Fan	4' X 10'	27	\$231.11	
EGDSF0414XX	EcoGuardDiamond Single Fan	4' X 14'	38	\$281.24	
EGDSF0418XX	EcoGuard Diamond Single Fan	4' X 18'	48	\$361.60	
EGDSF0420XX	EcoGuard Diamond Single Fan	4' X 20'	54	\$401.78	

MLL Item #	Description	Size	Weight	List	Colors
EGDDF0308XX	EcoGuard Diamond Double Fan	3' X 8'	16	\$120.53	Black (10) Charcoal (04) Green (08) Blue (02) Brown (14)
EGDDF0312XX	EcoGuard Diamond Double Fan	3' X 12'	24	\$180.80	
EGDDF0316XX	EcoGuard Diamond Double Fan	3' X 16'	32	\$241.07	
EGDDF0320XX	EcoGuard Diamond Double Fan	3' X 20'	40	\$301.33	
EGDDF0408XX	EcoGuard Diamond Double Fan	4' X 8'	22	\$160.71	
EGDDF0412XX	EcoGuard Diamond Double Fan	4' X 12'	32	\$241.07	
EGDDF0416XX	EcoGuard Diamond Double Fan	4' X 16'	43	\$321.42	
EGDDF0420XX	EcoGuard Diamond Double Fan	4' X 20'	54	\$402.00	

MLL Item #	Description	Size	Weight	List	Colors
EDGFAN0203XX	EcoGuard Diamond 3' Fan	2' X 3'	4	\$30.13	Black (10) Charcoal (04) Green (08) Blue (02) Brown (14)
EDGFAN0204XX	EcoGuard Diamond 4' Fan	2' x 4'	5	\$40.18	
EDGFAN0306XX	EcoGuard Diamond 6' Fan	3' X 6'	12	\$90.40	

ANTI-FATIGUE MAT COLLECTION

MARBLE TOP

MLL Item #	Description	Size	Weight	List	Colors
341830XX	Marble Top	18"x30"	6.5	\$58.58	Brown (20) Blue (40) Black/White (30) Grey (50)
341848XX	Marble Top	18"x48"	9.5	\$93.73	
342436XX	Marble Top	24"x36"	9.5	\$93.73	
343660XX	Marble Top	36"x60"	22	\$234.33	

PRO TOP

MLL Item #	Description	Size	Weight	List	Colors
440203XX	Pro Top Anti-Fatigue Mat	2'x3'	6	\$51.20	Black (35)
440305XX	Pro Top Anti-Fatigue Mat	3'x5'	15	\$128.00	Grey (50)

SOFT STEP

MLL Item #	Description	Color	Size	Weight	List
24020301	Softstep Anti-Fatigue Blk 2'x3'	Black	2'x3'	5	\$24.93
24030501	Softstep Anti-Fatigue Blk 3'x5'	Black	3'x5'	10	\$62.33
24031001	Softstep Anti-Fatigue Blk 3'x10'	Black	3'x10'	19.5	\$124.67
24031201	Softstep Anti-Fatigue Blk 3'x12'	Black	3'x12'	23.5	\$149.60
24020301GY	Softstep Anti-Fatigue Gry 2'x3'	Grey	2'x3'	5	\$24.93
24026001GY	Softstep Anti-Fatigue Gry 2'x60'	Grey	2'x60'	77	\$498.67
24273601GY	Softstep Anti-Fatigue Gry 27"X3'	Grey	27"X3'	7	\$28.04
24276001GY	Softstep Anti-Fatigue Gry 27"X5'	Grey	27"X5'	8.5	\$46.76
24030501GY	Softstep Anti-Fatigue Gry 3'x5'	Grey	3'x5'	10	\$62.33
24031201GY	Softstep Anti-Fatigue Gry 3'x12'	Grey	3'x12'	23.5	\$149.60
24036001GY	Softstep Anti-Fatigue Gry 3'x60'	Grey	3'x60'	113	\$748.00
24046001GY	Softstep Anti-Fatigue Gry 4'x60'	Grey	4'x60'	152	\$997.33
24066001GY	Softstep Anti-Fatigue Gry 6'x60'	Grey	6'x60'	230	\$1496.00
24026001	Softstep Anti-Fatigue Blk 2'x60'	Black	2'x60'	77	\$498.67
24273601	Softstep Anti-Fatigue Blk 27"X3'	Black	27"X3'	7	\$28.04
24276001	Softstep Anti-Fatigue Blk 27"X5'	Black	27"X5'	8.5	\$46.76
24036001	Softstep Anti-Fatigue Blk 3'x60'	Black	3'x60'	113	\$748.00
24046001	Softstep Anti-Fatigue Blk 4'x60'	Black	4'x60'	152	\$997.33
24066001	Softstep Anti-Fatigue Blk 6'x60'	Black	6'x60'	230	\$1496.00

AIR STEP

MLL Item #	Description	Color	Size	Weight	List
24020302	Air Step Anti-Fatigue Blk 2'x3'	Black	2'x3'	5	\$24.93
24273602	Air Step Anti-Fatigue Blk 27"X3'	Black	27"X3'	7	\$28.04
24276002	Air Step Anti-Fatigue Blk 27"X5'	Black	27"X5'	8.5	\$46.76
24026002	Air Step Anti-Fatigue Blk 2'x60'	Black	2'x60'	77	\$498.67
24030502	Air Step Anti-Fatigue Blk 3'x5'	Black	3'x5'	10	\$62.33
24031202	Air Step Anti-Fatigue Blk 3'x12'	Black	3'x12'	23.5	\$149.60
24036002	Air Step Anti-Fatigue Blk 3'x60'	Black	3'x60'	113	\$748.00
24046002	Air Step Anti-Fatigue Blk 4'x60'	Black	4'x60'	152	\$997.33
24066002	Air Step Anti-Fatigue Blk 6'x60'	Black	6'x60'	230	\$1496.00

ANTI-FATIGUE MAT COLLECTION

SOFT STEP SUPREME

MLL Item #	Description	SIZE	WEIGHT	LIST
24020301 DIAM	Soft Step Supreme Anti-Fatigue Diamond	2'x3'	6	\$48.13
24030501 DIAM	Soft Step Supreme Anti-Fatigue Diamond	3'x5'	14	\$120.33
24031201 DIAM	Soft Step Supreme Anti-Fatigue Diamond	3'x12'	33	\$288.80
24020301 PBL	Soft Step Supreme Anti-Fatigue Pebble	2'x3'	6	\$48.13
24030501 PBL	Soft Step Supreme Anti-Fatigue Pebble	3'x5'	14	\$120.33
24031201 PBL	Soft Step Supreme Anti-Fatigue Pebble	3'x12'	33	\$288.80

SAFE STEP

MLL Item #	Description	Color	Size	Weight	List
24020303	Safe Step Antifatigue Mat 2'x3'	Black / Yellow	2'x3'	10	\$91.87
24030503	Safe Step Antifatigue Mat 3'x5'	Black / Yellow	3'x5'	20	\$229.67
24031203	Safe Step Antifatigue Mat 3'x12'	Black / Yellow	3'x12'	42	\$551.20
24020303BLK	Safe Step Antifatigue Mat 2'x3'	Black	2'x3'	10	\$91.87
24030503BLK	Safe Step Antifatigue Mat 3'x5'	Black	3'x5'	20	\$229.67
24031203BLK	Safe Step Antifatigue Mat 3'x12'	Black	3'x12'	42	\$551.20
24020304BLK	Safe Step Supr 1" Blk 2'x3'	Black	2'x3'	10	\$126.67
24031204BLK	Safe Step Supr 1" Blk 3'x12'	Black	3'x12'	42	\$760.00
24030504BLK	Safe Step Supr 1" Blk 3'x5'	Black	3'x5'	20	\$316.67
24040603BLK	Safe Step Antifatigue Mat 4'x6'	Black	4'x6'	27	\$347.47
24040604BLK	Safe Step Supr 1" Black 4'x6' Mat	Black	4'x6'	31	\$506.67
24020304	Safe Step Supr 1" Blk/Ylw 2'x3'	Black/Yellow	2'x3'	10	\$126.67
24030504	Safe Step Supr 1" Blk/Ylw 3'x5'	Black/Yellow	3'x5'	20	\$316.67
24031204	Safe Step Supr 1" Blk/Ylw 3'x12'	Black/Yellow	3'x12'	42	\$760.00
24040603	Safe Step Antifatigue Mat 4'x6'	Black / Yellow	4'x6'	27	\$347.47
24040604	Safe Step Supr 1" Black/Yellow 4'x6' Mat	Black / Yellow	4'x6'	31	\$506.67

FLEX STEP

MLL Item #	Description	size	weight	list
24020300	Flex Step	2'x3'	4.5	\$47.87
24030500	Flex Step	3'x5'	22.5	\$119.67

KNEEL RELIEF

MLL Item #	Description	size	weight	list
24142101KNEE	Kneel Relief Anti-Fatigue Mat	14"x21"	2	\$16.60

UTILITY/FOOD SERVICE MAT COLLECTION

TRIPLE FLEX

MLL Item #	Description	Size	Weight	List
24020305	Triple Flex Flow AF 2'x3' BLK	2'x3'	5.5	\$56.27
24020305SCR	Triple Flex Scrape AF 2'x3' BLK	2'x3'	5.5	\$56.27
24030505	Triple Flex Flow AF 3'x5' BLK	3'x5'	12	\$140.67
24030505SCR	Triple Flex Scrape AF 3'x5' BLK	3'x5'	12	\$140.67
24031005	Triple Flex Flow AF 3'x10' BLK	3'x10'	22.5	\$281.33
24031005SCR	Triple Flex Scrape AF 3'x10' BLK	3'x10'	22.5	\$281.33
24040605	Triple Flex Flow AF 4'x6' BLK	4'x6'	18	\$225.07
24040605SCR	Triple Flex Scrape AF 4'x6' BLK	4'x6'	18	\$225.07

VERSA-LITE

MLL Item #	Description	Size	Weight	List
34030500	Versa-Lite 3'x5' Black	31"X62"	15	\$132.00

FREE FLOW COMFORT

MLL Item #	Description	Size	Color	Weight	List
34030401	Free Flow Comfort	3'x4'	Black	20	\$79.20

SAFTEY CHEF

MLL Item #	Description	Size	Color	Weight	List
54030501BLK	Safety Chef Black	3'x5'	Black	25.5	\$40.07
54030501TC	Safety Chef TerraCotta Red	3'x5'	Red	25.5	\$61.56

SAFETY CHEF LINKABLE

MLL Item #	Description	Size	Weight	List
54030302BLK	Safety Chef Linkable Black	3'x3'	18	\$28.89
54030302RTC	Safety Chef Linkable TerraCotta Red	3'x3'	18	\$37.20

MAT CARE INSTRUCTIONS:

Caring for your Guardian Floor Protection Mat is Easy.

Use the chart below to find out what options are best for your mat.

Ordering Logo Mats
Prestige Logo
Clean Step Logo Scraper
Media Mats
Motif Mats
EliteGuard Logo Inlay
WaterGuard Logo Inlay
Logo Impressions
Printed Message Mats
Photo Mats
Outdoor Mat Collection
Clean Step Scraper
Parquet Wiper Scraper
Brush Tip
Collection



	COMMERCIAL WASHING MACHINE	HOSE AND DRY	WET/DRY SHOP VACUUM	CARPET CLEANER	STANDARD VACUUM	DAMP CLOTH WASH	SHAKE OUT MAT
LOGO & MESSAGE MAT COLLECTION							
Prestige Logo	●		●	●	●		●
Clean Step Logo Scraper		●	●		●	●	●
Media Mat		●		●	●	●	●
Motif Mat			●	●	●		●
EliteGuard Logo Inlay		●	●	●	●		
WaterGuard Logo Inlay		●	●	●	●		●
Logo Impressions		●	●	●	●		●
Printed Message & Photo	●		●	●	●		●
OUTDOOR MAT COLLECTION							
Clean Step Scraper	●	●		●	●	●	●
Parquet Wiper Scraper		●		●	●		●
Brush Tip		●		●			●
INDOOR MAT COLLECTION							
EliteGuard		●	●	●	●		
WaterGuard & Diamond		●	●	●	●		●
Diamond Series		●	●	●	●		●
Platinum Series	●	●	●	●	●		●
Golden Series		●	●	●	●		●
Silver Series		●	●	●	●		●
EcoGuard & Diamond		●	●	●	●		●
ANTI-FATIGUE MAT COLLECTION							
Marble Top						●	●
Pro Top						●	●
Soft Step/Air Step						●	●
Soft Step Supreme	●	●	●			●	●
Safe Step						●	●
Flex Step						●	●
Kneel Relief		●				●	●
UTILITY/FOOD SERVICE MAT COLLECTION							
Triple-Flex Flow & Scrape	●	●	●		●	●	
Versa-lite	●	●	●		●	●	
Free Flow Comfort	●	●	●		●	●	
Safety Chef		●	●		●	●	



CONTACT US

for more information or
to place your order

GUARDIAN FLOOR PROTECTION

3200 Shawnee Industrial Way,
Suwanee, Georgia 30024

Tel : 678-482-5623 or 877-620-3822
Fax: 678-482-5620

Ordering Logo M
Prestige Lo
Clean Step Logo Scrap
Media M
Motif M
EliteGuard Logo Inl
WaterGuard
Logo Impress
Outdoor Mat Coll
Clean Step
Paper
Indoor Mat Collect
EliteGuard
WaterGuard
WaterGuard Diamo
Platinum Ser
Golden Ser
Silver Ser
EcoGuard
EcoGuard Diamo
Anti-Fatigue Mat Collec
Marble T
Pro T
Safe St
Flex St
Soft Step/ Air Ste
Soft Step Supren
Kneel Rel
Utility/ Food Ser
Mat Collect
Triple-Flex Flow & Scrap
Versa-L
Free Flow Comf
Safety Ch

Ordering Logo Mat
 Prestige Logo
 Clean Step Logo Scraper
 Media Mats
 Motif Mats
 SiteGuard Logo Inlay
 WaterGuard Logo Inlay
 Logo Impressions
 Printed Message Mats
 Photo Mats
 Outdoor Mat Collection
 Clean Step Scraper
 Marquet Wiper Scraper
 Push Tip
 Outdoor Mat Collection
 SiteGuard
 WaterGuard
 WaterGuard Diamond
 Platinum Series
 Golden Series
 Silver Series
 LogoGuard

Life Step
 Flex Step
 Soft Step/ Air Step
 Soft Step Supreme
 Heel Relief
 Hospitality/ Food Service
 Mat Collection
 Triple-Flex Flow & Scrape
 Versa-Lite
 Free Flow Comfort
 Safety Chef

GUARDIAN

FLOOR PROTECTION

3200 Shawnee Industrial Way
 Suwanee, GA 30024
877-620-3822

